

Makita[®]

Catálogo de
ACCESORIOS
2022



HISTORIA

Makita se ha convertido en uno de los grandes fabricantes mundiales de herramientas electroportátiles, con 11 plantas de fabricación repartidas por todo el mundo y un gran número de subsidiarias. Con una selección de más de 700 modelos de calidad superior y fabricados con la tecnología más avanzada, Makita ofrece la más amplia gama de herramientas eléctricas.

En Marzo de 1915, Mosaburo Makita, funda MAKITA ELECTRIC WORKS en la ciudad de Nagoya, una tienda especializada en la venta y reparación de motores eléctricos y transformadores.

En 1989 se funda Makita España, S.A. y en noviembre de 1991, cambia su nombre a Makita, S.A.

A través de los años la empresa inicial sufre varias transformaciones:

1915 Se funda Makita Electric Works en la ciudad de Nagoya. Comenzó vendiendo y reparando equipamiento eléctrico, motores, y transformadores.

1958 Se inició la comercialización de los cepillos eléctricos, el primer producto en Japón.



1969 Taladro a batería 6500D (la primera herramienta a batería).



1978 Se lanza el modelo 6010D taladro a batería (primera herramienta a batería de Ni-Cd).



1981 Se lanza el modelo AN5000 clavadora neumática y AC6001 compresor de aire (primeras herramientas neumáticas).



1989 Tres herramientas eléctricas (sierra circular, amoladora, taladro) diseñadas por Giorgetto Giugiaro se exhiben en la Exposición Mundial del Diseño en la ciudad de Nagoya.



1989 Se funda Makita España S.A (cambia a Makita, S.A. en 1991)



1991 Se adquiere Sachs Dolmar GmbH, fabricante de motosierras Alemán (cambia el nombre a Dolmar GmbH en 1991)

1991 Llega la segunda marca, MAKTEC.



1997 6213D Taladro atornillador a batería, se exhibe en el salón de ferretería de Chicago (primera herramienta con batería de Ni-MH).

2005 Llegan los modelos BTD130D (primeras herramientas con batería Litio-ion).



2007 Fuji Robin Industries Ltd. se convierte en una subsidiaria consolidada. (cambia su nombre a Makita Numazu Corporation en Agosto de 2007)

2015 Se celebra el 100 aniversario.



2019 30 ANIVERSARIO MAKITA S.A.



2020 Nace XGT, un nuevo sistema con sus propias herramientas, baterías y cargadores. Una combinación de herramientas innovadoras. El diseño y las baterías más potentes proporcionan una solución genuina para usuarios industriales de alta demanda.



2022 Llegamos donde menos te imaginabas. Lanzamos una serie de modelos dedicados al "Outdoor".



Makita - Marca global

Makita ha establecido bases comerciales operadas directamente en aproximadamente 50 países de todo el mundo y ha mejorado

Nuestra red de ventas en más de 160 países y nuestras capacidades de servicio postventa se convierten en una de las compañías líderes en nuestra industria.

Además, Makita está produciendo herramientas eléctricas en plantas en China, EE.UU., Reino Unido, Alemania, Brasil, Rumanía y Tailandia. Actualmente, aproximadamente el 90% del trabajo de fabricación de nuestro grupo en términos de volumen de producción se lleva a cabo en el extranjero.

La red mundial de ventas y servicios de Makita, así como la calidad estable y de alta producción asegurada en sus plantas en todo el mundo, son la encarnación de la marca Makita.

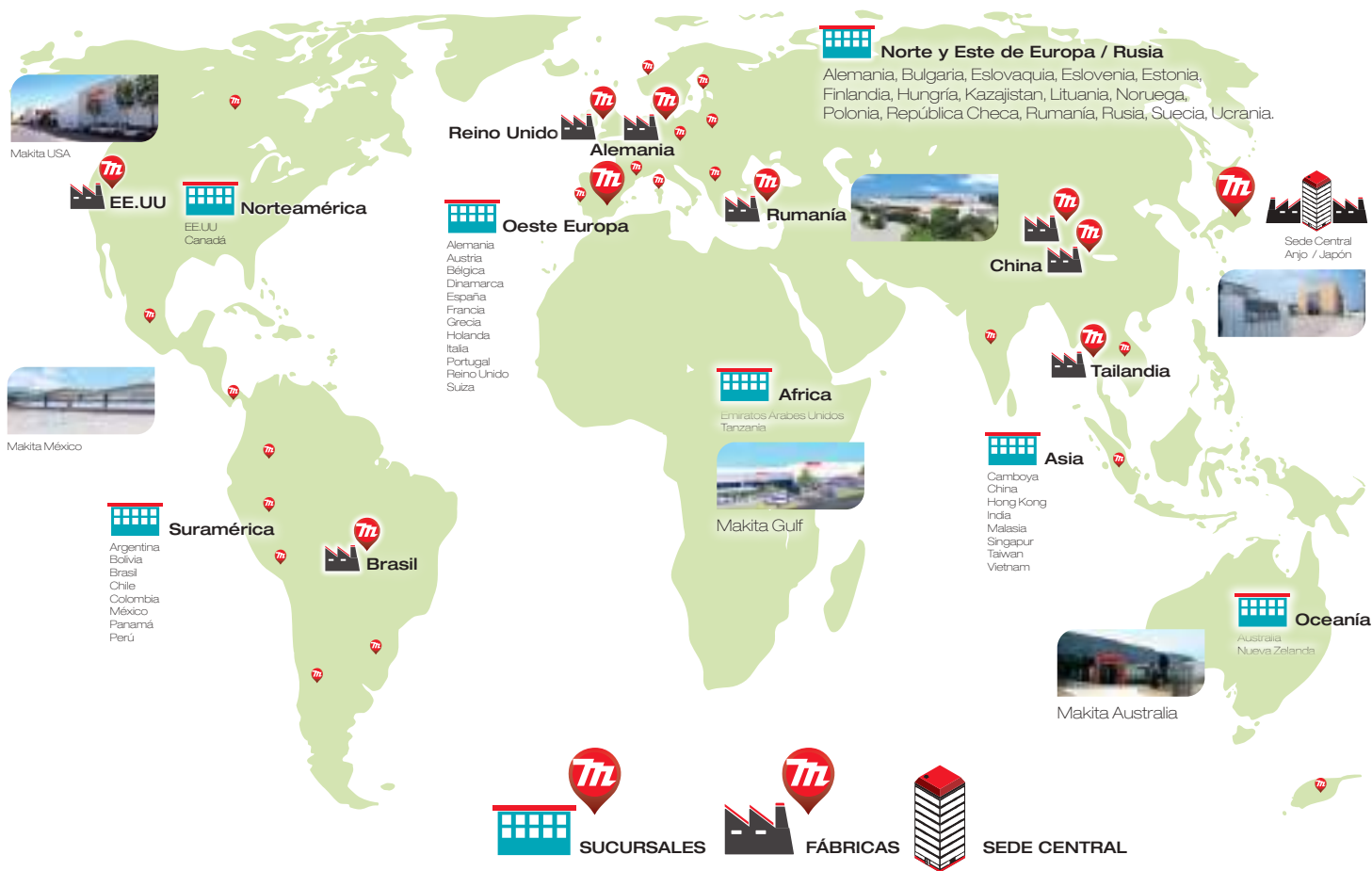

Japón
Makita Corporation



Japón
Planta Okazaki



U.S.A.
Makita Corporation of América



Reino Unido
Makita Manufacturing Europe Ltd.



Rumanía
SC Makita EU SRL



Alemania
Makita Engineering Germany



Brasil
Makita do Brazil Ferramentas Eléctricas Ltda.



China
Makita (China) Co., Ltd.



China
Makita (Kunshan) Co., Ltd.



Tailandia
Makita Manufacturing (Thailand) Co., Ltd.

*Por una sociedad
descarbonizada...*



**Ha llegado el momento
de cambiar la gasolina
por la batería,
está en nuestra mano cuidar
y respetar el medio ambiente.**

Zero
emisiones
Makita

LXT

36V

18V
LITHIUM-ION

XGT

XGT 12V
20V MAX

40V MAX

CXT

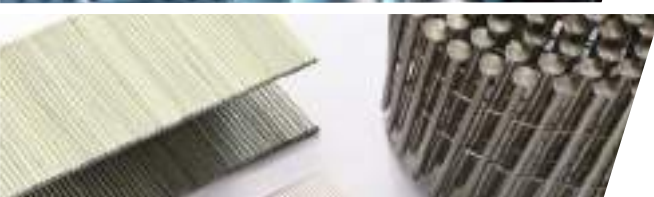

1. Baterías y cargadores	21 - 42
2. Perforación y demolición	43 - 74
3. Taladrar	75 - 106
4. Atornillar	107 - 126
5. Limpiar y cepillar	127 - 138
6. Diamante	139 - 152
7. Abrasivo - Amoladoras	153 - 170
8. Abrasivo - Lijas	171 - 186
9. Multiherramienta	187 - 200
10. Sierras circulares, ingletadoras y de incisión	201 - 224
11. Sierras de sable	225 - 238
12. Sierras de calar	239 - 250
13. Fresado	251 - 264
14. Decapar	265 - 268
15. Tornillos y clavos	269 - 274
16. Aspiración	275 - 292
17. Niveles	293 - 296
18. Roedoras, cizallas y punzonadoras	297 - 300
19. Jardín	301 - 324
20. Portaherramientas	325 - 375
21. Baterías NI-Cd / NI-Mh	376
22. Maletines	377 - 383
23. Escobillas	384 - 385
24. Kits de mantenimiento	386
25. Índice por código	387 - 396
Servicios Técnicos Autorizados	398 - 399

Índice

1. Batería y cargadores

- Baterías y cargadores. *págs. 22 - 25*
- Fuentes de alimentación externas. *págs. 26 - 27*
- Kits de fuentes de alimentación *pág. 28*
- Iluminación. *págs. 35 - 42*



2. Perforar y percudir

- Brocas SDS - PLUS. *págs. 44 - 51*



- Brocas SDS - MAX. *págs. 52 - 57*



- Demolición. *págs. 58 - 68*



- Portabrocas y varios. *pág. 69*



- Sistemas de aspiración. *págs. 70 - 73*



- Empuñaduras. *pág. 74*



3. Taladrar

- Brocas:

- Unicut. *pág. 76*
- Ladrillo. *pág. 77*
- Multimaterial. *pág. 78*
- Madera. *págs. 79 - 81*
- Metal. *págs. 82 - 86*

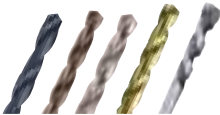

- Brocas para taladro magnético HB500 y HB350. *pág. 87*



- Avellanadores. *págs. 88 - 89*



- Estuches y maletines de brocas y accesorios. *págs. 90 - 97*



- Brocas de corona. *págs. 98 - 101*



- Batidores. *pág. 101*



- Soportes para taladros. *págs. 102 - 103*



- Portabrocas. *págs. 104 - 105*



4. Atornillar

- Puntas: *pág. 109 - 111*

Impact

PREMIER

págs. 112 - 113

IMPACT BLACK



- Portapuntas. *pág. 115*



- Llaves de vaso. *págs. 116 - 117*



- Estuches de puntas. *págs. 118 - 120*



- Maletines de herramienta manual. *págs. 120 - 122*



- Boquillas, vasos y acc. para atornilladores. *págs. 123 - 126*



5. Limpiar y cepillar

- Gratas para taladros y amoladoras. *págs. 128 - 133*

- Rodillos para N9741. *págs. 134 - 135*

- Cuchillas para cepillos. *pág. 136*

- Guías. *pág. 137*

- Varios. *págs. 138*



6. Diamante

- Discos de diamante:

quasar *págs. 141*

comet *págs. 142 - 144*

diamant *pág. 145*

Especial herramientas a batería *pág. 146*

X - LOCK *pág. 146*

Especial vidrio y porcelánico *pág. 147*

Especial rescate - Pulir ormigón *pág. 148*

- Brocas de diamante. *págs. 150 - 151*

- Brocas especiales para amoladora. *pág. 151*

- Soportes para DBM131, DBM130 y DBM230. *pág. 152*

- Acc. para PW5005CH. *pág. 152*

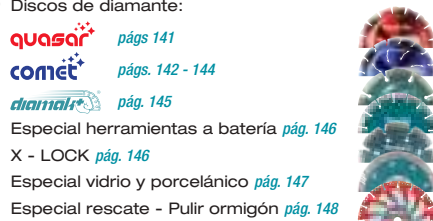

7. Abrasivo - Amoladoras

- Discos abrasivos:

Desbarbe y corte. *págs. 155 - 156*

Abrasivo. *págs. 156 - 157*

Láminas. *págs. 157 - 161*

- Muelas. *pág. 161*

- Empuñaduras. *pág. 162*

- Colectores de polvo. *pág. 162*

- Protectores de disco. *pág. 163*

- Varios:

Tuercas. *pág. 164*

Filtros. *pág. 164*

Casquillos para amoladoras rectas. *pág. 166*

- Acc. para cortadores. *págs. 167*

- PW5000CH. *pág. 168*

- PC5001C. *págs. 168 - 170*

- DCC501. *pág. 170*

8. Abrasivo - Lijas

- Orbitales. *págs. 172 - 176*

- Lijas.
- Rollos.
- Bases para lijadoras.

- Rotorbitales y de disco. *págs. 177 - 179*

- Lijas.
- Cajas de lijas.
- Platos.

- Lijadoras de banda. *págs. 180 - 181*

- Lijas.
- Placas.

- Platos, boinas de lana. *págs. 182 - 183*

- Esponjas de velcro. *pág. 183*

- Varios *págs. 184 - 186*

- Soportes.
- Bolsas.
- Empuñaduras...



Índice

9. Multiherramienta

- Starlock:
 - Corte y corte de inmersión. *págs. 192 - 193*
 - Rascadores y cuchillas de corte. *pág. 194*
 - Limpieza y corte. *págs. 195 - 196*
 - Set de cuchillas. *pág. 196*
 - Lijas. *pág. 197*
- Starlock Max:
 - Corte y corte de inmersión. *pág. 198*
 - Cuchillas de corte de juntas y de diamante. *págs. 199*
 - Cuchillas de corte para azulejos *pág. 200*
 - Limpieza y corte *pág. 200*



10. Sierras

- Discos para sierras circulares. *págs. 206 - 211*

MAKFORCE

MFORCE

SPECIALIZED STANDARD

SPECIALIZED CONSTRUCCION

SPECIALIZED MAQUINAS DE BATERIA

SPECIALIZED REFORZADO

SPECIALIZED STANDARD

SPECIALIZED ALUMINIO

SPECIALIZED PANEL SANDWICH



- Discos para sierras de incisión. *pág. 212*

SPECIALIZED INCISION

- Discos para ingletadoras. *págs. 213 - 216*

MAKBLADE PLUS

SPECIALIZED S. MESA

SPECIALIZED ALUMINIO

SPECIALIZED LAMINADOS



- Discos para fresado y corte. *pág. 217*
- Discos laminados cortadoras de metal. *págs. 218 - 219*
- Guías. *pág. 220 - 221*
- Mesas. *pág. 221 - 222*
- Varios: *págs. 222 - 224*
 - Topes.
 - Soportes
 - Mordaza



11. Sierras de sable

- Metal. *págs. 227 - 228*
- Madera. *págs. 229 - 230*
- S-Express. *pág. 230*
- Madera + Metal. *págs. 231 - 232*
- Especiales. *pág. 233*
- JR100D y DJR183. *pág. 234*
- Hojas para 2107FK / 2107FXK. *pág. 235*
- DPB181 y DSD180. *pág. 236*
- Acc. para LB1200. *pág. 237*
- Acc. para 2107FK. *pág. 238*



12. Sierras de calar

- Super Express. *pág. 242*
- Madera:
 - Corte básico. *pág. 242*
 - Corte rápido. *pág. 243*
 - Laminadas. *pág. 243*
 - Corte limpio. *pág. 244*
 - Maderas duras. *pág. 244*
 - Con clavo. *pág. 245*
- Metal. *pág. 245*
- Especiales. *pág. 246*
- Conjuntos de hojas a granel. *pág. 247*
- Inserción Makita. *págs. 248*
- Mordazas, guías y adaptadores. *pág. 250*



13. Fresado

- Madera. *págs. 253 - 256*
- Taladrar aluminio. *pág. 257*
- Para 3706, DCO180 y DCO181. *pág. 257*
- PJ7000 y 3901. *pág. 258*
- 7104L. *pág. 258*
- Varios: *págs. 259 - 260*
 - Casquillos.
 - Tuercas.
 - Llaves.
- Guías: *págs. 261 - 262*
 - Plantilla.
 - Carril.
- RT0700C. *págs. 263 - 264*



14. Decapar

- Boquillas. *págs. 267 - 268*



15. Tornillos y clavos

- Ristras de tornillos para autoalimentados. *pág. 271*
- Clavos: *págs. 272 - 273*
 - DPT351 y DPT353 - 0,6mm.
 - AF505N y DBN500 - 1,2mm.
 - AN250HC - Multimaterial.
 - GN420C - Multimaterial.
 - Cargador de clavos - GN420C
- Grapas. *pág. 273*
- Varios. *pág. 274*



16. Aspiración

- Accesorios para aspiradores. *págs. 278 - 280*
 - Tubos:
 - Flexibles.
 - Curvos.
 - Rectos.
 - Pies.
 - Boquillas.
- Filtros. *pág. 282*
- Bolsas. *pág. 283*
- Conexiones para aspiradores. *págs. 284 - 291*
- DRC200. *pág. 292*



17. Láser

- Varios. *págs. 294 - 296*



18. Roedoras, cizallas y punzonadoras

- JS8000. *pág. 298*
- Troqueles. *pág. 298*
- Cuchillas. *pág. 298*
- Accesorios para punzonadora DPP200. *págs. 299 - 300*



19. Jardín

- Barras, cadenas, fundas y acc. para sierras de cadena y cortasetos *págs. 304 - 306*
- Acc. para sopladores. *pág. 307*
- Acc. para UX001G / DUX60 / DUX18. *pág. 309*
- Discos y cabezales para desbrozadores. *pág. 310 - 313*
- Hilos de nylon. *págs. 314 - 315*
- Aceites. *pág. 316*
- Correa y protección para desbrozadores. *pág. 317*
- Acc. para ahoyadora DDG460. *pág. 318*
- Brocas para suelo 3/4". *pág. 319*
- Acc. para DUC122 y UC120D. *pág. 319*
- Acc. para tijeras de poda. *pág. 320*
- Acc. para cortasetos y cortahierbas. *pág. 321*
- Hidrolimpiadoras. *págs. 322 - 324*
 - Lanzas y pistolas
 - Mangueras.
 - Cepillos.
 - Adaptadores.
- Accesorios para DCU180 *pág. 324*



Makita. Recomendaciones de seguridad.

Importante



- Cuando utilice herramientas eléctricas, siempre deben seguirse unas recomendaciones de seguridad básicas para reducir el riesgo de incendio, electroshock y daños personales, como las que se indican a continuación.

Mantenga la zona de trabajo limpia

Las zonas y mesas de trabajo desordenadas pueden provocar lesiones.

Tenga en cuenta el ambiente de trabajo

No utilice herramientas eléctricas en ambientes húmedos o mojados. Mantenga el Área de trabajo iluminada. No esponga herramientas eléctricas a la lluvia. No utilice herramientas eléctricas en presencia de líquidos o gases inflamables.

Mantenga a los niños alejados

Todos los visitantes deben mantenerse alejados de la zona de trabajo. No permita que los visitantes toquen la herramienta o los cables de extensión.

Guarde las herramientas en un lugar apropiado

Cuando no se encuentren en uso, las herramientas deben ser guardadas en un lugar seco y a una altura que las mantenga fuera del alcance de los niños.

No fuerce la herramienta

Realizará mejor su trabajo y de una manera más segura al paso para el que ha sido destinado.

Use la herramienta apropiada

No fuerce pequeñas herramientas o accesorios para hacer el trabajo de una herramienta mayor. No utilice herramientas para propósitos para los que no han sido diseñadas.

Vista de forma adecuada

No lleve ropa holgada o joyas. Pueden quedarse atrapadas entre partes móviles. Se recomienda el uso de guantes de goma y calzado antideslizante para trabajos en el exterior.

Haga un uso adecuado del cable

Nunca mueva la herramienta por su cable ni tire de él para desconectarlo del enchufe. Mantenga el cable lejos del calor, aceite y ángulos afilados.

Trabaje de manera segura

Utilice abrazaderas para sostener el trabajo. Es más seguro que usar su mano para sostenerlo y le permite utilizar la herramienta con ambas manos.

No se extralimite

Manténgase en todo momento seguro y en equilibrio.

Mantenga las herramientas con cuidado

Mantenga las herramientas de corte afiladas y limpias para un uso más seguro y eficaz. Siga las instrucciones sobre lubricación y cambio de accesorios. Inspeccione el cable de la herramienta periódicamente y si está dañado, repárelo en un servicio autorizado. Inspeccione los cables de extensión periódicamente y cámbielos si están dañados. Mantenga los mangos secos, limpios y libres de grasa y aceite.

Desconecte las herramientas

Cuando no se encuentren en uso, antes de utilizarlas y cuando cambie accesorios como cuchillas.

Retire las llaves de ajuste e inglesas

Acostúmbrese a comprobar que ha retirado las llaves de ajuste o inglesas que haya utilizado para ajustar la máquina antes de su encendido.

Evite el encendido accidental

No lleve una herramienta conectada con un dedo en el interruptor. Asegúrese de que el interruptor está en la posición OFF cuando vaya a conectarlo.

Utilice extensores para exterior

Cuando utilice la herramienta en ambientes externos utilice solo cables de extensión destinados a este uso.

Manténgase a alerta

Observe lo que está haciendo. Utilice el sentido común. No utilice la herramienta cuando esté cansado.

Compruebe las partes dañadas

Antes de seguir utilizando la herramienta, las protecciones o cualquier parte que se encuentra dañada, deben ser comprobadas para determinar si funcionarán correctamente y ejecutarán su propósito. Compruebe la alineación y el desplazamiento de los elementos móviles, roturas, montaje y cualquier otra condición que pueda dañar su funcionamiento. Los protectores o cualquier otra parte dañada deben ser reemplazados o reparados por un servicio autorizado a menos que se indique de otra manera en su manual de instrucciones. Reemplace sus interruptores en un servicio autorizado. No utilice la herramienta si el interruptor no la enciende ni apaga.

Protéjase contra electroshocks

Evite el contacto directo del cuerpo con superficies con toma de tierra (por ejemplo, tuberías, radiadores, refrigeraciones, etc...)

Repuestos

Utilice solamente recambios idénticos a la pieza original.

Advertencia de voltaje

Antes de conectar la herramienta a una fuente de alimentación. Asegúrese de que el voltaje suministrado es idéntico al que figura en la placa nominativa de la herramienta. Un voltaje mayor al especificado en la herramienta podría causar SERIOS DAÑOS al operario así como a la propia herramienta. En caso de duda, NO CONECTE LA HERRAMIENTA. Usar una fuente de alimentación con voltaje menor al indicado es perjudicial para el motor.

NOTA

Makita se reserva el derecho a cambiar especificaciones de las herramientas, equipos básicos y accesorios sin previo aviso. El equipamiento básico y especificaciones de piezas puede variar según el país. El color estándar de fábrica es el Verde Industrial Makita (azul). Por favor indique el voltaje necesario en cada pedido. Estas ofertas están sujetas a disponibilidad en cada país.

El color de los productos puede variar ligeramente con respecto al color reproducido en el presente catálogo.

Se recomienda siempre completar la información contenida en este catálogo mediante consulta telefónica o correo electrónico.

Makita Limited

Garantía

Todas las herramientas Makita sufren un duro proceso de inspección y testeo antes de abandonar la fábrica. Están garantizadas contra defectos de fabricación y/o materiales. Si algún problema hace aparición, por favor envíe la herramienta COMPLETA a Makita o entréguela en su punto de venta habitual. Si tras la inspección se demuestra que el problema es debido a un fallo de fabricación/material, todas las reparaciones necesarias será efectuadas sin coste alguno. La garantía no cubre reparaciones llevadas a cabo por terceros; reparaciones debidas a un desgaste normal; uso inapropiado de la herramienta o caída accidental; mal uso evidente - causado por sobrecargar la herramienta por encima de su capacidad, usar la herramienta después de una avería parcial o usarla con accesorios inadecuados.

Riesgos y desventajas del uso de falsificaciones

ATENCIÓN: Makita informa

- Lamentablemente, la tendencia de comprar online ha creado espacios para los oportunistas y estafadores que buscan aprovecharse del consumidor a toda costa. Los productos de imitación relacionados con la construcción se están volviendo cada vez más comunes en internet, particularmente a través de subastas donde el vendedor es anónimo, y su uso puede generar graves problemas. A continuación explicamos las claves para diferenciar nuestras herramientas y accesorios originales:



Logotipo de Makita

El logotipo de Makita tiene que estar moldeado directamente en la carcasa de la herramienta y con el símbolo de marca registrada ®.



Etiqueta

Las etiquetas de Makita tienen que coincidir en modelo y especificaciones con la herramienta que las lleva. Las etiquetas falsas suelen tener el nombre del modelo en minúscula.



Acabado

El acabado de las herramientas Makita es metálico pulido. Las falsificaciones suelen llevar un baño de laca para aparentar este brillo.



Componentes

Los componentes de las herramientas Makita son siempre de calidad superior, más duraderos y de mejor material.

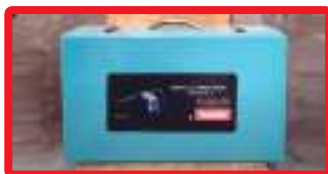

Packaging

Los maletines o cajas de cartón donde vienen las herramientas de Makita tienen mayor calidad y protegen mejor el producto ya que se adaptan mejor al modelo que contienen.



Componentes

Registrando la herramienta en www.makita.es, Makita otorga hasta tres años de garantía a todos sus modelos. Dentro de la caja se encuentran los comprobantes de dicha garantía, que las falsificaciones no tendrán.

ATENCIÓN: UTILICE BATERÍAS ORIGINALES

Seguridad

En muchos casos, los productos falsificados no han sido fabricados ni testeados de acuerdo con los estándares de calidad y seguridad requeridos por la ley. Entre estos riesgos se encuentra el peligro de que el producto quede dañado como resultado de una fuga o sobrecalentamiento de la batería hasta tal punto que pueda incendiarse.

Calidad

No es posible garantizar el rendimiento correcto de una batería falsificada. Hay baterías no originales en el mercado que afirman tener los mismos Ah que las baterías de Makita, pero son significativamente menos potentes. Una batería original de Makita también incluirá un chip incorporado que optimiza la vida útil de la batería.

Cómo identificar baterías falsificadas

Al comprar productos es importante reconocer aquellas señales de advertencia que indiquen que el producto es original. Recomendamos comprar a distribuidores autorizados de Makita España y ser cauteloso con los vendedores con precios inusualmente bajos.



Gracias a los aspiradores Makita, conseguirás un espacio limpio y seguro.

El filtro HEPA elimina más del 99,75% de las partículas que hay en el aire.



HEPA
filter



Nuevas Baterías de mochila 18Vx2 LXT / 36V / 40Vmax 33,5Ah

Hasta 6 veces más de tiempo de trabajo
con herramientas de 18Vx2 LXT y 6,0Ah.



PDC1200A01*
PDC1200A02

LXT 18Vx2 LXT **36V** **XGT** **40Vmax**



* Incluye adaptador 18Vx2 LXT



- El arnés de extracción rápida permite el uso de esta batería como fuente de alimentación fija.
- Interruptor de alimentación principal con función de apagado automático.



Ajuste de altura de la batería para comodidad del usuario.



Indicador de carga de batería de 4 LED.

PDC1200A01* **PDC1200A02**
1.800,00 € **1.690,00 €**

- El modelo PDC1200 es una batería con una capacidad de 1200 Wh, 33,5Ah y un voltaje 36V - 40Vmax (aproximadamente).
- Hasta 2,8 veces más de tiempo de duración que nuestra mochila portabaterías PDC01 cargada con 4 baterías 18V LXT 6,0Ah (BL1860B).
- Compatible con tres plataformas: 18Vx2 LXT (con adaptador opcional), conexión de alimentación directa de 36V y próximamente con 40Vmax XGT (adaptador en desarrollo).
- Batería no compatible con aspiradores, tijeras de poda, sierras de cadena a excepción del modelo DUC355, sierra circular DHS710 y la serie de martillos ligeros DHR280.
- Gracias a la estructura del arnés, la batería puede mantenerse en el suelo de forma vertical.

XGT **40V** Li-Ion **max**



XGT es un NUEVO sistema con sus propias herramientas, baterías y cargadores. Una combinación de herramientas innovadoras. El diseño y las baterías más potentes proporcionan una solución genuina para usuarios industriales de alta demanda.



BL4050

Batería 5,0 Ah Li-Ion.
Tiempo aprox. de carga:
50 min. con
cargador rápido.



BL4040

Batería 4,0 Ah Li-Ion.
Tiempo aprox. de carga:
45 min. con
cargador rápido.



BL4025

Batería 2,5 Ah Li-Ion.
Tiempo aprox. de carga:
28 min. con
cargador rápido.

BATERÍA **DE ALTA POTENCIA**



- XGT es una solución genuina para las aplicaciones industriales de alta demanda, siendo una combinación del diseño innovador de la herramienta y la alta potencia ofrecida por las baterías.

TECNOLOGÍA **INTELIGENTE**



- La gama de herramientas y baterías XGT lleva un programa incorporado, que proporciona una comunicación digital entre la batería y la herramienta. Permite no solo la comunicación de la batería a la herramienta, sino que también la herramienta se comunique con la batería.

DURABILIDAD



- ¡XGT es duradero y está diseñado para trabajar! Las baterías y herramientas XGT también han sido construidas para soportar las condiciones ambientales difíciles.

LISTO PARA **EL FUTURO**



- XGT y LXT convivirán para proporcionar a los usuarios una gama inigualable de herramientas a batería en las aplicaciones comerciales profesionales y aplicaciones de alta demanda energética.



MAKITA OFRECE LA VISIÓN DE FUTURO DE LAS HERRAMIENTAS SIN CABLE

La innovación sin cables es más que sólo mejores baterías.

Se trata de que crear una tecnología de baterías e ingeniería de motores que trabajen juntas para un rendimiento óptimo.



BL4020

Batería 2,0 Ah Li-Ion.
Tiempo aprox. de carga:
22 min. con
cargador rápido.



DC40RA

Cargador rápido para baterías
40Vmax XGT estilo rail con
ventiladores.



ADP10

Adaptador, permite que el
cargador DC40RA también
cargue baterías 18V LXT.



Características

La gama de herramientas y baterías XGT vienen con un chip incorporado, que proporciona comunicación digital entre la batería y la herramienta y el cargador. Tecnología de la batería e ingeniería del motor para que trabajen juntos de una manera óptima.

Las baterías tienen raíles rígidos que las mantienen firmemente en su lugar cuando se utilizan los nuevos productos de alta potencia.

Paredes de protección. Protegen los terminales de agua y polvo.

Indicador de carga de 4 LED que se encuentra en la parte delantera de la batería para que sea fácil saber cuándo debe recargarse.

El resistente diseño de 40Vmax carga las baterías en tan solo 28 minutos (BL4025).

Un accesorio adaptador de carga permite la carga de productos LXT y XGT (más de 320 en total).

Sistema óptimo de carga

Cargador rápido

- Si la temperatura de la batería es alta, es necesario que ésta se enfríe antes de comenzar la carga.
- El ventilador incorporado hace circular el aire a través de la batería antes de comenzar a cargar y durante el proceso de carga para enfriarla. De esta forma, el tiempo de carga es menor.

- El cargador rápido de Makita se comunica con el chip incorporado de la batería durante todo el proceso de carga para optimizar la vida útil de la batería controlando activamente la corriente, el voltaje y la temperatura.

- Sistema óptimo de carga.
- Sistema de carga general.
- Enfriamiento por aire forzado.
- Enfriamiento natural.



• Carga rápida.

• Tiempo de espera para cargar.

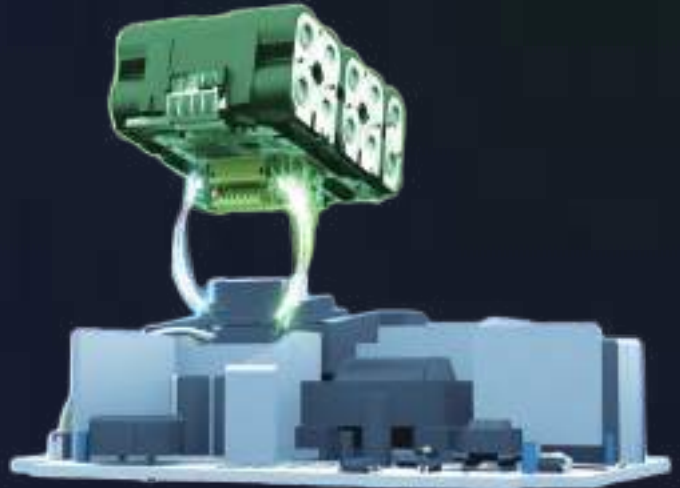

Sistema óptimo de carga

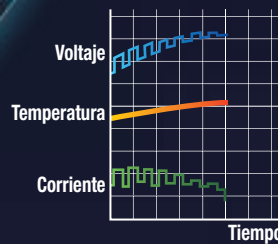

Sistema de carga general

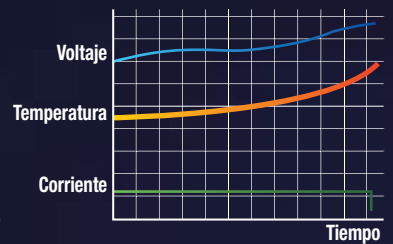

40% más ligera



Makita
18V Litio-Ion 5,0Ah
14,4V Litio-Ion 5,0Ah

Makita
18V / 14,4V
Ni-Mh 2,8Ah



*Terminales multicontacto
Reducen la resistencia eléctrica y aumentan la estabilidad de la conexión. Resistentes contra las vibraciones, y en última instancia asegura suministro de corriente estable a la herramienta.*



Protección de la batería

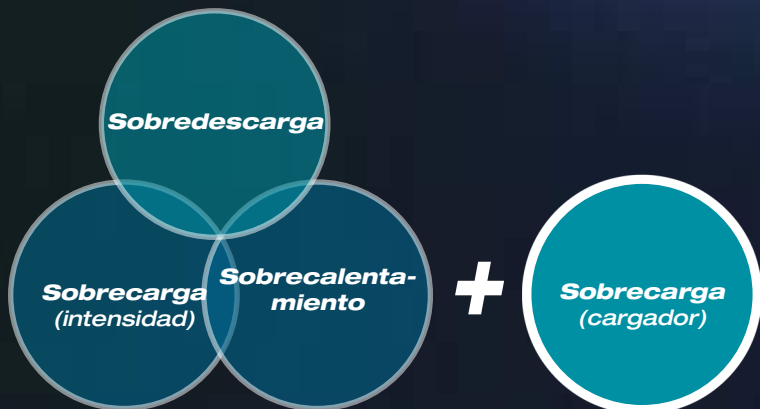

- Esta función es la tecnología de comunicación que permite la herramienta y la batería para monitorear las condiciones e intercambiar datos en tiempo real. De esta forma se protege contra sobrecarga y sobrecalentamiento.

Carga en cualquier momento
Sin efecto memoria.
No se requiere descarga.



Muy resistente.
Carcasa dura.



Larga duración.
Baja auto descarga.



Motor sin escobillas

- Motor sin escobillas Makita:
- Elimina las escobillas de carbón, lo que permite que el motor funcione más frío y de forma más eficiente para una vida útil más duradera.
- Este motor está controlado electrónicamente, y por ello, utiliza la energía para hacer coincidir el par y las RPM con los cambios de aplicación.

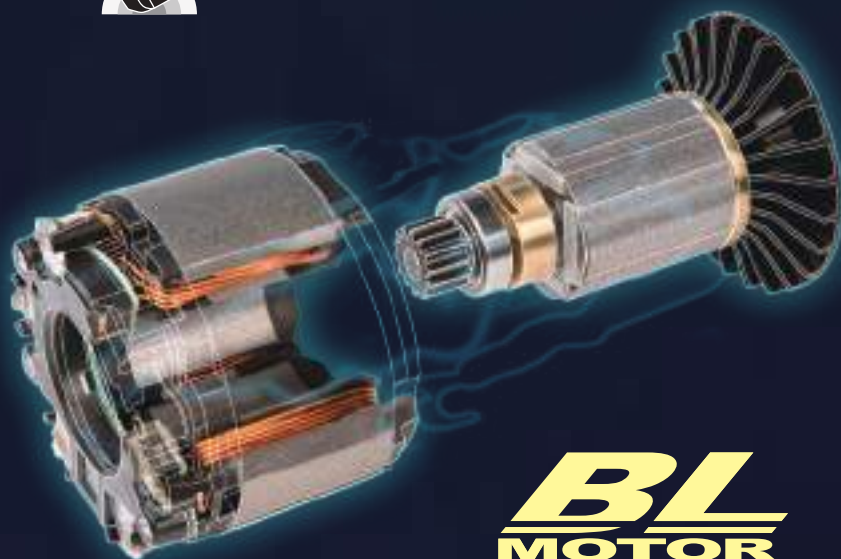

BL
MOTOR

Baterías y Cargadores con Sistema Óptimo de Carga.

DC18RC



DC18RD



Cargador rápido
con dos puertos.

DC18RE



Cargador rápido
con dos puertos
CXT y LXT.

DC18SF



Multicargador 4 puertos.
* Excepto BL1420A.

DC18SD



DC18SE



Automóvil.

Accesorios ideales para herramientas a batería



¡Proporcionan el mejor rendimiento en las herramientas a batería!

Mayor velocidad, más cantidad de trabajo con una sola carga de batería completa y una buena sensación de uso.

Puede encontrar accesorios recomendados para herramientas a batería con los símbolos arriba indicados.

¡Pruebe y vea nuestra amplia gama de accesorios Makita!



Impact
PREMIER



Mayor precisión de encaje.

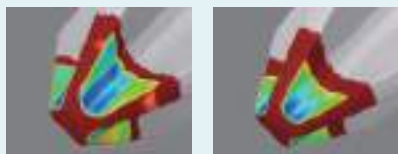

Con un tornillo cerca

Con un tornillo a distancia



Impact
PREMIER

Estándar

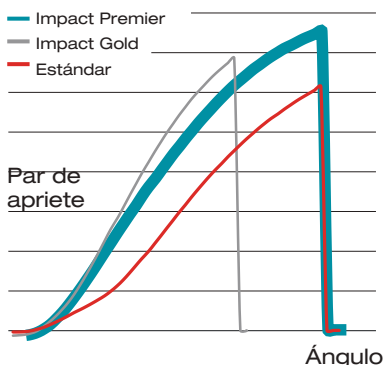

Doble torsión que consigue mayor durabilidad.



Sierra de sable de diente japonés



Dientes japoneses de 0,6mm de grosor para un corte más limpio del material.

Sierra de diente japonés:

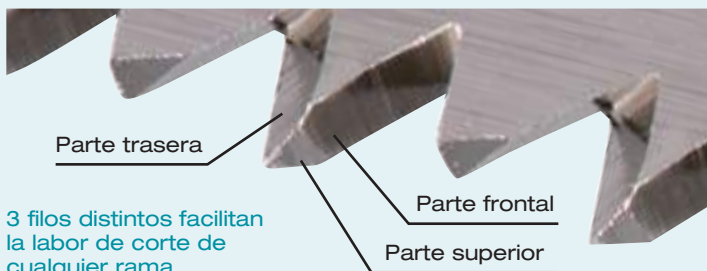

Calidad superior



Acabado con diente japonés



Acabado con diente normal



Hilo de nylon de cuatro hojas

Cuatro hojas

Forma de cuatro hojas que reduce el ruido y aumenta el tiempo de trabajo.



Características

La forma del hilo de cuatro hojas crea un pequeño vértice que reduce el ruido del corte y alarga el tiempo trabajo debido a que ejerce menos resistencia.

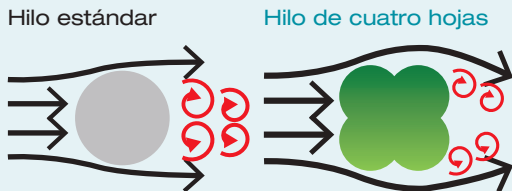

Cantidad de cortes por una carga

Ruido

120
20% más
100

90,5dB
6,5dB menos
97dB



Redondo

Cuatro hojas

Redondo

Cuatro hojas



Cadena para sierras serie 80



Características

Forma de corte óptima para corte suave

Paso de cadena corto para reducir la vibración

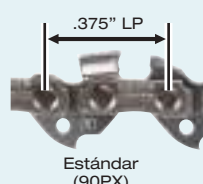
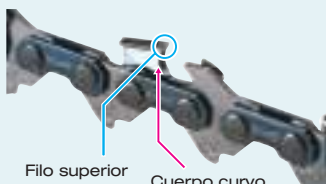

Vibración

85
15% menos
100

Cantidad de cortes por una carga

125
20% más
100

20% más



Sierras circulares TCT EFFICUT



EFFICUT



Características

Eficiente
Ángulo superior agudo

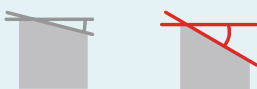

Eficiente
Cuerpo curvo



Eficiente
Base rectificada



Cantidad de cortes por una carga

100

140%
más

240

Estándar
165mm x 48T

EFFICUT
165mm x 56T

EFFICUT Composite

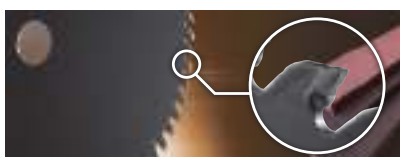

Características

Eficiente
Base rectificada



Eficiente
Cuerpo curvo



Cantidad de cortes por una carga

100

30%
más

130

Estándar
180mm x 40T

EFFICUT
185mm x 40T

EFFICUT Metal

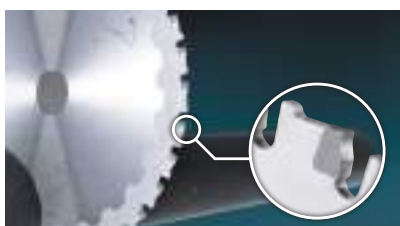

Características

Reduce la rebaba
Mayor robustez



Corte más suave
Reduce ruido y vibración



Mayor productividad
Superior en corte recto



Cantidad de cortes por una carga

100

60%
más

160

Estándar
150mm x 32T

EFFICUT
150mm x 33T

EFFICUT Aluminio



Características

Reduce la rebaba
Mayor robustez



Corte más suave
Reduce ruido y vibración



Mayor productividad
Superior en corte recto



Optimización del trabajo
Menor resistencia de corte



Cantidad de cortes por una carga

100

40%
más

140

Estándar
260mm x 80T

EFFICUT
260mm x 81T



Disco de diamante segmentado
Ideal para cortadores a batería

Los diamantes se distribuyen en la estructura del segmento, así se logra un mayor rendimiento de trabajo.
Ranuras más estrechas, mayor capacidad de corte.

Cantidad de cortes por una carga

Estándar

100

65%
más

165

Para batería

Disco abrasivo para metal
Ideal para cortadores a batería

Mezcla ideal de grano abrasivo y aglomerante para cortadores a batería.

Cantidad de cortes por una carga

Estándar

100

10%
más

110

Para batería



0,8mm



Disco de corte fino

0,8mm de grosor para un corte más rápido

Grosor reducido

Corte rápido / menor resistencia de corte / mejores acabados / menor producción de polvo



Estándar
1mm de grosor



Para batería
0,8mm de grosor

Cantidad de cortes por una carga

100

120

20% más

2,2mm



Disco de desbarbe 2 en 1

Capaz de cortar y desbarbar

Un tipo de corte especializado

Gracias a un grosor de 2,2mm y un grano "SA", proporciona mayor velocidad de corte y un desbarbado más seguro.



Estándar
2 en 1



Para batería
2 en 1

Cantidad de cortes por una carga

100

115

15% más



Disco de desbarbe flexible

Con baja vibración y sin inserción

Estructura anti-vibración

Compuesta de materiales que absorben las vibraciones. La velocidad de corte se ve aumentada gracias a su flexibilidad. Mayor eficiencia.



Estándar
(115 x 6mm)



Para batería
(115 x 4mm)

Cantidad de cortes por una carga

100

170

70% más

1,4mm

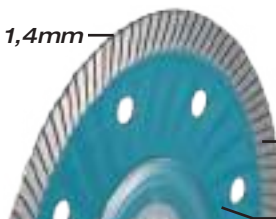

Disco de diamante seg.

Corte suave y preciso

Grosor reducido sin perder fuerza

Con 1,4mm consigue un cortes suaves y precisos.

Con un interior corrugado que aumenta la tensión y reduce las vibraciones durante el corte.

Para azulejos



Estándar
2,3mm de grosor



Para batería
1,4mm de grosor

Cantidad de cortes por una carga

100

160

60% más

1,6mm

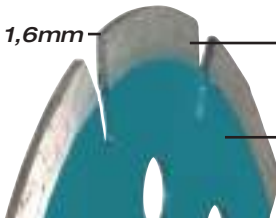

Especial para trabajos de corte

Con 1,6mm consigue un cortes suaves y precisos en cemento o piedra.

El cuerpo del disco es más ligero que en los modelos anteriores, haciendo más fácil el corte y aumentando el tiempo de uso con una batería totalmente cargada.

Para cemento / piedra



Estándar
2,2mm de grosor



Para batería
1,6mm de grosor

Cantidad de cortes por una carga

100

150

50% más

XLOCK

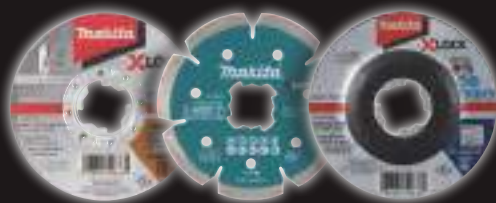

Disco de corte fino

Disco de diamante

Disco de desbarbe



Cambio rápido

Aumenta la rapidez en el cambio de accesorios sin piezas de intercambio.



Sin herramientas

El cambio de disco se puede realizar sin necesidad de herramientas externas.



2,5mm



Disco abrasivo para metal

Especial para trozadoras

Grosor reducido y aglomerante óptimo

2,5mm de grosor de disco para un corte suave y más rápido. Con un aglomerado óptimo que aumenta la vida útil del disco.



Estándar
3mm de grosor



Para batería
2,5mm de grosor

Cantidad de cortes por una carga

100

130

30% más





GAMA DE EXTERIORES
OUTDOORS



MEJORA TU EXPERIENCIA



XGT **40V** Li-ion
max

LXT
Litio-ion **EXTREMA TECNOLOGIA**

CXT

Batería



Baterías XGT, LXT, cargadores y compatibilidad de carga



CARGADOR DOBLE RÁPIDO

DC40RB
191N09-8



258€

CARGADOR RÁPIDO

DC40RA
191E07-8



160€

DC40RC
191M90-3



93€



5,0 Ah		314€ BL4050F 191L47-8
4,0 Ah		268€ BL4040 191B26-6
2,5 Ah		211€ BL4025 191B36-3
2,0 Ah		191€ BL4020 191L29-0

Tiempo de carga		
50 min.	50 min.	85 min.
45 min.	45 min.	67 min.
28 min.	28 min.	38 min.
22 min.	22 min.	30 min.

18V Litio-Ion

DC40RA 191E07-8 **160€** + ADP10 191C10-7 **66€**



6,0 Ah		232€ BL1860B 197422-4
5,0 Ah		201€ BL1850B 197280-8
4,0 Ah		170€ BL1840B 197265-4
3,0 Ah		144€ BL1830B 197599-5
2,0 Ah		113€ BL1820B 197254-9
1,5 Ah		93€ BL1815N 196235-0



Tiempo de carga	
40 min.	
35* min.	
29 min.	
22 min.	
24 min.	
15 min.	

* Solo baterías cuya primera letra de su identificativo sea "I" ó "J"



Baterías LXT, cargadores y compatibilidad de carga

 DC18RC 195584-2	 DC18RD 196933-6 2 puertos	 DC18RE 198720-9 2 puertos CXT/LXT	 DC18SF 196426-3 Multicargador 4 puertos * Excepto BL1430A.	 DC18SH 199687-4 Cargador 2 puertos	 DC18SD 194533-6	 DC18SE 194622-7 Automóvil
CARGADOR RÁPIDO		CARGADOR DOBLE RÁPIDO				
112€	206€	175€	294€	113€	76€	113€

18V Litio-Ion

		Tiempo de carga			
		De 1 a 2 baterías		De 2 a 4 baterías	
6,0 Ah	 232€ BL1860B 197422-4	55 min.	130 min.	260 min.	130 min.
5,0 Ah	 201€ BL1850B 197280-8	45 min.	110 min.	220 min.	110 min.
4,0 Ah	 170€ BL1840B 197265-4	36 min.	90 min.	180 min.	90 min.
3,0 Ah	 144€ BL1830B 197599-5	22 min.	60 min.	120 min.	60 min.
2,0 Ah	 113€ BL1820B 197254-9	24 min.	45 min.	90 min.	45 min.
1,5 Ah	 93€ BL1815N 196235-0	15 min.	30 min.	60 min.	30 min.

14,4V Litio-Ion

		Tiempo de carga			
		De 1 a 2 baterías		De 2 a 4 baterías	
4,0 Ah	 165€ BL1440 196388-5	36 min.	90 min.	90 min.	180 min.
3,0 Ah	 139€ BL1430B 197615-3	22 min.	60 min.	60 min.	120 min.
1,5 Ah	 110€ BL1415N 196875-4	15 min.	30 min.	30 min.	60 min.

Baterías Li-ion, CXT, cargadores y compatibilidad de carga

18V
Litio-Ion

1,5 Ah



72€

BL1815G
198186-3

Para los modelos:
DF457D, HP457D, JV183D,
TD127D y DMR106.

14,4V
Litio-Ion

1,5 Ah



62€

BL1415G
198192-8

Para los modelos:
DF347D, HP347D,
JV143D y DMR106.



53€

DC18WA
195423-6

70 min.

CXT
12V



112€

DC10SB
197363-4



77€

DC10WD
197343-0

4,0 Ah



91€

BL1041B 197406-2

60 min.

130 min.

2,0 Ah



70€

BL1021B 197396-9

30 min.

70 min.

10,8V
Litio-Ion



47€

DC10WA
194588-1

1,3 Ah



57€

BL1013 196066-7

50 min.

7,2V
Litio-Ion



52€

1,5 Ah

BL7015 198000-3



Adaptadores de corriente



Adaptador para
DMR100 / DMR102
DMR107
SE00000078 **16,5€**



Adaptador para
DCF201
TEB0000006 **32€**



Adaptador para
DMR106 / DMR108
DMR112
SE00000101 **24€**



Adaptador para
DMR200
DMR201
SE00000501 **14,4€**



Adaptador para
ADP07
DF001D
198363-7 **12,6€**



Adaptador para
DMR115
SE00000679 **31€**



Adaptador 12-24V
para DCW180
WL00000002 **9,25€**



Adaptador 220V
para DCW180
WL00000058 **77€**



Cargador DC4001
para PDC1200
191L00-4 **196€**



FUENTES DE ALIMENTACIÓN EXTERNAS

PDC1200

Nueva batería de mochila 18Vx2 LXT / 40V máx

33,5Ah

Tiene una capacidad de 1200 Wh, 33,5Ah y un voltaje 36V - 40V máx (aproximadamente).

Hasta 2,8 veces más de tiempo de duración que nuestra mochila portabaterías PDC01 cargada con 4 baterías 18V LXT 6,0Ah.

Compatible con: 18Vx2 LXT (adaptador opcional), conexión de alimentación directa de 36V y con 40V máx XGT (adaptador opcional).

Hasta 6 veces más de tiempo de trabajo con herramientas de 18Vx2 LXT y 6,0Ah.



IPX4



Cargador: DC4001
Tiempo de carga: 6 horas

Funciones y beneficios

- Con batería integrada de 40V máx.
- Alta capacidad: 1.200Wh. (aprox. 6 veces más tiempo de trabajo que con herramientas de 18Vx2 LXT con BL1860Bx2)



Altura ajustable

La posición del arnés se puede ajustar para mayor confort.



Arnés de extracción rápida

Se puede unir y soltar de la unidad de batería con un sólo movimiento.



Reflectores

Para una mayor visibilidad del usuario incluso en la oscuridad.

PDC1200A01 **1.854€***
PDC1200A02 **1.741€**
*Incluye adaptador 18Vx2

Mochila portabaterías

PDC01

IPX4



191C50-5
incluye adaptadores
18V y 18Vx2
4 baterías 5,0 Ah
Multicargador 2 puertos
1.777€

191A59-5
incluye adaptadores
18V y 18Vx2
953€

191A64-2
incluye adaptador
18Vx2
680€

Funciones y beneficios

- Con la posibilidad de conectar hasta 4 baterías LXT de 18V
- Alta capacidad: 432 Wh (con 4 baterías BL1860B)



Altura ajustable

La posición del arnés se puede ajustar para mayor confort.



Arnés de mochila

Se puede separar del compartimento de las baterías, convirtiéndose así en una fuente de alimentación fija.



Indicador de carga

Indica el estado de carga de cada batería con luces verdes. Con función de auto apagado.



Tipos de conexión y adaptadores

Conexión directa



40V máx



Adaptador 155€

191N62-4



18Vx2



Adaptador 180€

191J51-5



18V (sólo PDC01)



Adaptador 124€

191J50-7



Especificaciones

	PDC1200	PDC01
Capacidad	33,5 Ah	*
Almacenamiento	1.206 Wh	*
Número de células	100	-
Tiempo de carga (horas)	6	-
Dimensiones (L x An x Al)	sin arnés: 369x261x139 mm	sin arnés: 400x195x132 mm
	con arnés: 428x261x164 mm	con arnés: 400x270x149 mm
Peso neto	sin arnés: 8,8 kg	sin baterías: 2,8 kg

* Dependerá de las baterías seleccionadas





Kits de fuentes de alimentación

- Kits de baterías: 2 baterías de 5,0Ah, multicargador rápido y maletín Makpac3.



191U13-9 5,0 Ah 803€



2x BL4050F
1x DC40RB
1x 821551-8

- Kits de baterías: 2 baterías de 4,0Ah, multicargador rápido y maletín Makpac3.



191U00-8 4,0 Ah 711€



2x BL4040
1x DC40RB
1x 821551-8

- Kits de baterías: Baterías de 4,0Ah y cargador rápido.



191J65-4 4,0 Ah 386€



1x BL4040
1x DC40RA

- Kits de baterías: 2 baterías de 4,0Ah, cargador rápido y maletín Makpac1.



191J97-1 4,0 Ah 695€



2x BL4040
1x DC40RA
1x 821549-5

- Kits de baterías: 2 baterías de 2,5Ah, cargador rápido y maletín Makpac1.



191J81-6 2,5 Ah 505€



2x BL4025
1x DC40RA
1x 821549-5

- Kits de baterías: Baterías de 2,5Ah y cargador rápido.



191J39-5 2,5 Ah 479€



2x BL4025
1x DC40RA

- Kits de baterías: 2 baterías de 6,0Ah, cargador rápido y maletín Makpac1.



198116-4 6,0 Ah 618€



2x BL1860B
1x DC18RC
1x 821549-5

- Kits de baterías: 2 baterías de 6,0Ah, multicargador rápido y maletín Makpac3.



198077-8 6,0 Ah 670€



2x BL1860B
1x DC18RD
1x 821551-8

- Kits de baterías: 2 baterías de 5,0Ah, multicargador rápido y maletín Makpac3.



197626-8 5,0 Ah 824€



4x BL1850B
1x DC18RD
1x 821551-8

Baterías y cargadores

Descripción	Código	EAN	P.V.P (€)
Cargador rápido XGT - DC40RA	191E07-8	0088381556354	160,00
Cargador XGT - DC40RC	191M90-3	0088381579261	93,00
Multicargador 2 puertos XGT - DC40RB	191N09-8	0088381579117	258,00
Cargador 7,2V-18V LXT - DC18RC	195584-2	0088381373562	112,00
Multicargador rápido 2 puertos LXT - DC18RD	196933-6	0088381444033	206,00
Multicargador 2 puertos LXT - DC18SH	199687-4	0088381542470	113,00
Multicargador 4 puertos LXT - DC18SF	196426-3	0088381432979	294,00
Cargador 12V CXT / 18V LXT - DC18RE	198720-9	0088381487924	175,00
Cargador 18V LXT - DC18SD	194533-6	0088381345811	76,00
Cargador coche LXT - DC18SE	194622-7	0088381349673	113,00
Mochila portabaterías - PDC01	191A59-5	0088381548588	953,00
Mochila portabaterías - PDC01 con adaptador (x2)	191A64-2	0088381548632	680,00
Mochila portátil con baterías	191C50-5	0088381553544	1.777,00
Batería de mochila LXT / 40Vmax 33,5Ah + Adaptador - PDC1200A01	PDC1200A01	0088381728621	1.854,00
Batería de mochila LXT / 40Vmax 33,5Ah - PDC1200A02	PDC1200A02	0088381728645	1.741,00
Kit fuente de alimentación 6,0Ah BL1860B x2 + DC18RC + MakPac 3	198116-4	0088381474146	618,00
Kit fuente de alimentación 6,0Ah BL1860B x2 + DC18RD + MakPac 3	198077-8	0088381474511	670,00
Kit fuente alimentación 5,0Ah BL1850B x4 + DC18RD + MakPac 3	197626-8	0088381463164	824,00
Kit fuente alimentación XGT BL4025 x2 + DC40RA	191J39-5	0088381561006	479,00
Kit fuente alimentación XGT BL4040 x2 + DC40RA + MakPac 1	191J97-1	0088381561389	695,00
Kit fuente alimentación XGT BL4025 x2 + DC40RA + MakPac 1	191J81-6	0088381561228	505,00
Kit fuente alimentación XGT BL4050F x2 + DC40RB + MakPac 3	191U13-9	0088381583039	803,00
Kit fuente alimentación XGT BL4040 x2 + DC40RB + MakPac 3	191U00-8	0088381582902	711,00
KIT FUENTE 40VMAX 4,0AH XGT BL4040X1 + DC40RA	191J65-4	0088381561068	386,00
Batería 40Vmax 5,0Ah XGT - BL4050F	191L47-8	0088381580946	314,00
Batería 40Vmax 4,0Ah XGT - BL4040	191B26-6	0088381557498	268,00
Batería 40Vmax 2,5 Ah XGT- BL4025	191B36-3	0088381556521	211,00
Batería 40Vmax 2,0 Ah XGT - BL4020	191L29-0	0088381574549	191,00

Descripción	Código	EAN	P.V.P (€)
Batería 18V 6,0Ah LXT - BL1860B	197422-4	0088381464123	232,00
Batería 18V 5,0Ah LXT - BL1850B	197280-8	0088381459129	201,00
Batería 18V 4,0Ah LXT - BL1840B	197265-4	0088381459068	170,00
Batería 18V 3,0Ah LXT - BL1830B	197599-5	0088381464055	144,00
Batería 18V 2,0Ah LXT - BL1820B	197254-9	0088381459037	113,00
Batería 18V 1,5Ah LXT - BL1815N	196235-0	0088381417556	93,00
Batería 14,4V 4,0Ah LXT - BL1440	196388-5	0088381426671	165,00
Batería 14,4V 3,0Ah LXT - BL1430B	197615-3	0088381465083	139,00
Batería 14,4V 1,5Ah LXT - BL1415N	196875-4	0088381443746	110,00
Batería 18V 1,5Ah - BL1815G	198186-3	0088381475891	72,00
Batería 14,4V 1,5Ah - BL1415G	198192-8	0088381475952	62,00
Cargador 18V Litio-ion - DC18WA	195423-6	0088381371575	53,00
Batería 12V 4,0Ah CXT - BL1041B	197406-2	0088381461658	91,00
Batería 12V 2,0Ah CXT - BL1021B	197396-9	0088381459839	70,00
Cargador rápido 12V CXT - DC10SB	197363-4	0088381459563	112,00
Cargador 12V CXT - DC10WD	197343-0	0088381459211	77,00
Batería 10,8V Litio - BL1013	196066-7	0088381405423	57,00
Cargador 10,8V - DC10WA	194588-1	0088381348065	47,00
Batería 7,2V Litio - BL0715	198000-3	0088381473392	52,00
Adaptador BMR100 - 383PCC0B11	SE00000078	0088381447829	16,50
Adaptador BCF201ZW	TEB0000006	3240890380852	32,00
Adaptador DMR106	SE00000101	0088381425162	24,00
Adaptador DMR115	SE00000679	-	31,00
Adaptador DMR100 - 3A8A12C133B11	SE00000501	0088381534826	14,40
Adaptador DF001DW - ADP07	198363-7	0088381525671	12,60
Adaptador 12-24V DCW180	WL00000002	-	9,25
Adaptador 220V DCW180	WL00000058	-	77,00
Cargador DC4001	191L00-4	0088381570688	196,00



Adaptadores

- PDC01



191J50-7

- PDC01
- PDC1200



191J51-5

- PDC01
- PDC1200



191N62-4



Para	Descripción	Unds.	Código	EAN	P.V.P (€)
LXT	Adaptador simple LXT 18V	1	191J50-7	0088381560375	124,00
LXT	Adaptador doble LXT 18Vx2	1	191J51-5	0088381560382	180,00
XGT	Adaptador simple XGT 40Vmax.	1	191N62-4	0088381580342	155,00

Adaptador de batería para el cinturón BAP36N y BAP182

- Permite separar la batería de la herramienta y así reducir el peso de la máquina para menor fatiga en el brazo.



* Adaptador no válido para BC231UD y UX361D.

Modelo	Para	Descripción	Unds.	Código	EAN	P.V.P (€)
BAP36N *	36V	Permite separar la/s batería/s de la herramienta y así conseguimos reducir el peso de la misma.	1	195311-7	0088381363181	72,00
BAP182	18Vx2		1	197580-6	0088381463119	141,00

Convertidor de batería

- Con dos baterías de 18V (BL1860B, BL1850B, BL1840B, BL1830B) se pueden utilizar las máquinas de 36V.

BCV01 *

18V x 2



BCV03

18V x 2



* Adaptador no válido para BC231UD y UX361D.

Modelo	Para	Descripción	Unds.	Código	EAN	P.V.P (€)
BCV01 *	36V	Adaptador 2 baterías de 18V a una de 36V Maleta+cable+adaptador	1	195511-9	0088381371650	130,00
BCV03	36V	Adaptador 2 baterías de 18V a 36V Adaptador directo en la máquina	1	197214-1	0088381459013	115,00

Adaptadores USB



DEBADP05

Para	Descripción	Unds.	Código	EAN	P.V.P (€)
LXT 18V	Adaptador para USB	1	DECADP05	-	30,00
CXT 12V	Adaptador para USB con gancho para cinturón	1	DEAADP06	0088381825108	29,00
CXT 12V	Adaptador para USB	1	DEAADP08	0088381853224	29,00

Adaptador para baterías Ni-Cd / Ni.Mh



Para	V	Unds.	Código	EAN	P.V.P (€)
Baterías Ni-Cd y Ni-MH	9,6 18V	1	193947-6	0088381188395	47,00

Protectores de batería anti-polvo y agua

- Diseñado para proteger la batería del polvo y agua en condiciones adversas.



Para	Válido para	Unds.	Código	EAN	P.V.P (€)
14,4V BL1430B BL1440B	Taladros	1	195797-5	0088381376525	46,00
18V BL1830B BL1840B BL1850B	Atomilladores de impacto Llaves de impacto	1	195798-3	0088381376532	48,00

Protector de batería

- Diseñado para proteger la batería contra golpes accidentales y humedad.



Para	Unds.	Código	EAN	P.V.P (€)
BL1830 BL1840 BL1850 BL1860	1	459938-0	-	7,70
BL1415	1	454407-6	-	4,65
BL1815 BL1820B	1	459937-2	-	6,20

Conectores de batería para chaquetas



GM00001607



GM00001605



FE00000037



YL00000004

Modelos		Unds.	Código	EAN	P.V.P (€)
Chaquetas ventiladas	LXT 18V	1	198634-2	0088381486675	46,00
	CXT 12V	1	GM00001605	0088381472975	45,00
Chaquetas calefactables	LXT 18V	1	YL00000004	0088381537094	44,00
	CXT 12V	1	YL00000003	0088381537087	38,00

Sistema AWS



El sistema AWS (Automatic Wireless System) nos permite conectar el aspirador en modo autoconexionado con las máquinas que dispongan de AWS, poniéndose en funcionamiento solo cuando accionamos la máquina sin necesidad de cables.



Descripción	Unds.	Código	EAN	P.V.P (€)
Dispositivo AWS conexión Bluetooth	1	198900-7	0088381497749	55,00

Filtro para chaquetas ventiladas



Modelos	Unds.	Código	EAN	P.V.P (€)
DFJ301Z DFJ201Z	1	GM00001499	0088381471299	23,00

Accesorios para pistola de silicona DCG180

A 196351-8



Despiece:

- Boquilla A (tipo cartucho) 454275-7
- Junta de boquilla A 454223-6
- Rack 42 142042-1
- Pistón A 142071-2

B 191P89-6 / 196352-6

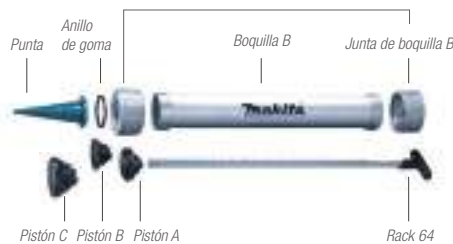

Despiece:

- Boquilla B 141861-0
- Junta de boquilla B 318958-2
- Anillo de goma 424547-4
- Punta de boquilla 454226-0
- Rack 64 142042-9
- Pistón A (tipo cartucho) 142071-2
- Pistón B (tipo salchicha) 142072-0
- Pistón C (sellador a granel) 123221-8

C 197195-9



Despiece:

- Boquilla C 455951-6
- Junta de boquilla C 455952-4
- Junta de boquilla C (completa) 143223-8
- Pistón D (tipo cartucho) 143221-2
- Rack 53 143220-4



Capacidad	Tipo	Descripción	Unds.	Código	EAN	P.V.P (€)
300ml	A	Para colocar tubos de silicona de 300 ml	1	196351-8	0088381424271	43,00
400ml	B	Para colocar silicona en salchicha o a granel	1	191P89-6	0088381580915	89,00
600ml	B		1	196352-6	0088381424288	98,00
800ml	C	Para colocar tubos de silicona de 800 ml	1	197195-9	0088381458221	71,00

Boquilla de silicona. Para tipos B y C

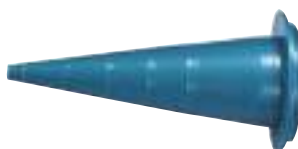

Tipo	Descripción	Unds.	Código	EAN	P.V.P (€)
B C	Boquilla de silicona reocortable	1	454226-0	0088381437080	3,85

Accesorios para remachadora



Set de mordazas para remachadoras



Descripción	Unds.	Código	EAN	P.V.P (€)
Set de mordazadas para DRV150	1	199731-7	0088381568647	14,40
Set de mordazadas para DRV250	1	199730-9	0088381568630	14,40

Boquillas para remaches DRV150 / DRV250



Descripción	Modelo	Unds.	Código	EAN	P.V.P (€)
2,4 mm	DRV150	1	199729-4	0088381567299	34,00
3,2 mm		1	199728-6	0088381567282	33,00
4,0 mm		1	191C04-2	0088381567275	16,50
4,8 mm		1	191C03-4	0088381567268	16,50
4,0 mm	DRV250	1	191F80-4	0088381567336	57,00
4,8 mm		1	191F79-9	0088381567329	27,00
6,0 mm		1	199725-2	0088381567312	27,00
6,4 mm		1	191F78-1	0088381567305	27,00

Accesorios para engrasadora DGP180



Descripción	Unds.	Código	EAN	P.V.P (€)
Depósito tipo B 450g	1	191A81-2	0088381558440	92,00
Depósito tipo B 400g	1	191B12-7	0088381558433	91,00
Depósito tipo A 400g	1	191F24-4	0088381558464	72,00

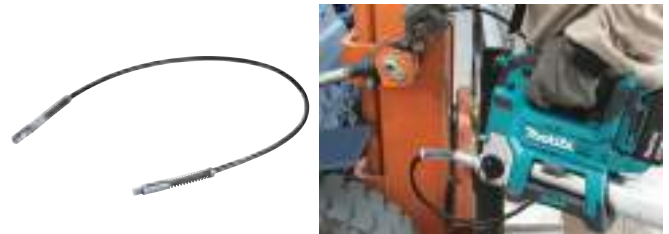

Descripción	Unds.	Código	EAN	P.V.P (€)
Manguera flexible 1.200 mm	1	191A79-9	0088381558501	77,00
Manguera flexible 600 mm	1	191A80-4	0088381558518	62,00



Descripción	Unds.	Código	EAN	P.V.P (€)
Adaptador de boquilla angular	1	191A77-3	0088381567213	73,00
Adaptador de boquilla con bloqueo	1	191A76-5	0088381567206	129,00



Descripción	Unds.	Código	EAN	P.V.P (€)
Set de adaptadores (3 piezas)	1	191A78-1	-	44,00

Sets de alambre para atadora de ferralla DTR180 y extensión de mango



Extensión de mango

- Extensión de mango para DTR180 indicado para reducir el esfuerzo y la fatiga en la espalda. También incluye guía acolchada para el antebrazo.



* Herramienta no incluida

Descripción	Unds.	Código	EAN	P.V.P (€)
Mango extensor	1	191M27-0	0088381572675	185,00



Descripción	Unds.	Código	EAN	P.V.P (€)
Set de alambre 50 rollos	1	199137-9	0088381533928	188,00



Descripción	Unds.	Código	EAN	P.V.P (€)
Set de alambre galvanizado 50 rollos	1	191A57-9	0088381547949	268,00



- 50 rollos de alambre de 100 metros cada uno.
- Diámetro del hilo 0,8mm.

Descripción	Unds.	Código	EAN	P.V.P (€)
Set alambre poliester 50 rollos	1	191J59-9	0088381560894	371,00

Accesorios para infladores



TE00000333



TE00000334



TE00000335





















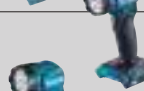



Descripción	Unds.	Código	EAN	P.V.P (€)
Boquilla para inflador <0,5 bar	1	TE00000333	0088381547918	0,80
Boquilla para inflador 0,7 bar	1	TE00000334	0088381547925	0,50
Boquilla para inflador 0,9 bar	1	TE00000335	0088381547932	0,55



ILUMINACIÓN



Comparativa de focos y linternas

Modelo				Lúmenes	Iluminancia / modos	AC / DC
DML810		✓		Alto - 5.500 Lm Medio - 3.000 Lm Bajo - 1.500 Lm	Alto - 550 Lx Medio - 300 Lx Bajo - 150 Lx (a 1m de distancia)	✓
DML814		✓		Alto - 3.000 Lm Medio - 1.700 Lm Bajo 900 Lm	Alto - 1250 Lx Medio - 750 Lx Bajo - 400 Lx (a 1m de distancia)	-
ML003GZ		✓	✓	Alto - 1.100Lm Bajo - 450Lm	Alto - 500 Lx Bajo - 200 Lx (a 1m de distancia)	-
DEADML809			✓	Alto - 10.000 Lm Medio - 4.000 Lm Bajo - 2.000 Lm	Alto - 3.800 Lx Medio - 1.500 Lx Bajo - 800 Lx (a 1m de distancia)	✓
DEADML805			✓	Alto - 750 Lm Bajo - 450 Lm	Alto - 300 Lx Bajo - 200 Lx (a 1m de distancia)	✓
DML811			✓	Alto - 3.000 Lm Medio - 1.500 Lm Bajo - 750Lm	Alto - 1.800 Lx Medio - 800 Lx Bajo - 350 Lx (a 1m de distancia)	✓
DML812			✓	Proyector - 600 Lm Lupa - 1.000 Lm Mixto - 1.250 Lm	Spot - 71.000 Lx Flood - 520 Lx Spot-Flood - 51.000 Lm (a 1m de distancia)	-
ML001G		✓		160 Lm	3.000 Lx (a 1m de distancia)	-
DEADML815			✓	160 Lm	3.000 Lx (a 1m de distancia)	-
DEAML105			✓	190 Lm	5.500 Lx (a 1m de distancia)	-
DEBDML808			✓	190 Lm	Alto - 4.500 Lx Bajo - 170 Lx (a 1m de distancia)	-
DEBDML802			✓	180 Lm	4.000 Lx (a 1m de distancia)	-
DEAML106			✓	190 Lm	Alto - 4.500 Lx Bajo - 170 Lx (a 1m de distancia)	-
ML002		✓		360° - 710 Lm 180° - 340 Lm Modo linterna 130 Lm		
DEAML104			✓	Luz principal - 710 Lm Luz secundaria - 130 Lm		
ML006GX		✓		Alto - 500 Lm Medio - 250 Lm Bajo - 100 Lm	Alto - 500 Lx Medio - 250 Lx Bajo - 100 Lx (a 1m de distancia)	-
DML816X			✓	Alto - 500 Lm Medio - 250 Lm Bajo - 100 Lm	Alto - 800 Lx Medio - 400 Lx Bajo - 180 Lx (a 1m de distancia)	-
DEBDML806			✓	Luz principal - 620 Lm Luz secundaria - 310 Lm	Luz principal - 310 Lm Luz secundaria - 280 Lm	-
DEBDML801			✓	240Lm	12 Leds - 240 Lm 6 Leds - 120 Lm	-
DEBDML800			✓	100 Lm	-	-
DEAML103			✓	100 Lm	-	-
DEBDML186			✓	6 Leds	500 Lx a 1 metro de distancia	-

640 M
MODO SPOT

10 M

6 M

4,5 M

Distancia

2,3 M

2,8 M

2,8 M

DML805

ML003G

DML812

DML814

DML811

DML810

DML809

6,5 M

Linterna de área 5.500LM - DML810

- 3 ajustes de brillo: 5.500 / 3.000 / 1.500 Lm.
- 3 niveles de iluminancia: 550 / 300 / 150Lx. *
- Bloqueo de la tapa de la batería para proteger la batería del robo.
- Capaz de conectar hasta 8 unidades DML810 en serie.
- Alojamiento para dos baterías LXT.
- Certificación IP54 de resistencia al polvo y al agua. **
- Tiempo de iluminación: 3,5H en modo alto con BL1850Bx2.
- AC/DC.



*A 1m de distancia. ** Sólo con alimentación DC.

Dimensiones	Unds.	Código	EAN	P.V.P (€)
420 x 420 x 787mm	1	DML810	0088381891103	489,00



Trípode regulable 3.000 Lm - DML814

- 3 ajustes de brillo: 3.000 / 1.700 / 900 Lm.
- 3 niveles de iluminancia: 1.250 / 750 / 400Lx. *
- 3 cabezales individuales giratorios.
- Luz LED blanca, ideal para trabajo.
- Los cierres tienen con un tornillo de ajuste.
- Tapa de batería con candado.
- Plegable en un tamaño compacto para un almacenamiento y transporte sencillo.
- Tiempo de iluminación: 3H en brillo alto con BL1850B.

Primer trípode de iluminación Makita



Dimensiones	Unds.	Código	EAN	P.V.P (€)
573 x 658 x 2.240mm	1	DML814	0088381728614	422,00



Nuevos focos de iluminación

Luces LED de alta intensidad para un mayor rango.
Hasta 10 horas de iluminación continua.
Con una potencia de hasta 10.000 lúmenes.
Compatibles con baterías XGT y LXT



Foco de iluminación 1.100Lm - ML003G

- 2 ajustes de brillo: 1.100 / 450 Lm.
- 2 niveles de iluminancia: 500 / 200 Lx. *
- Función de memoria en la configuración de brillo.
- Clasificación IP65 para resistencia al agua.
- Tiempo de iluminación: 10H en brillo alto con BL4040.



Dimensiones	Unds.	Código	EAN	P.V.P (€)
249 x 298 x 280 mm	1	ML003GZ	0088381746632	216,00

Foco de iluminación 750Lm - DEADML805

- 2 ajustes de brillo: 750 / 450 Lm.
- 2 niveles de iluminancia: 300 / 200 Lx. *
- Muy ligero. Asa a modo de gancho.
- Tiempo de iluminación: 8,5H modo alto con BL1850.



Dimensiones	Unds.	Código	EAN	P.V.P (€)
214 x 261 x 328 mm	1	DEADML805	0088381699303	174,00

Foco de iluminación 10.000Lm - DEADML809

- 3 ajustes de brillo: 10.000 / 4.000 / 2.000 Lm.
- 3 niveles de iluminancia: 3.800 / 1.500 / 800 Lx. *
- Clasificación IP65 para resistencia al agua.
- Tiempo de iluminación: 1,4H en modo alto con BL1850x2.



Dimensiones	Unds.	Código	EAN	P.V.P (€)
249 x 370 x 370mm	1	DEADML809	0088381888264	443,00



Descripción	Unds.	Código	EAN	P.V.P (€)
Sujección gancho	1	GM00001396	0088381455688	20,10
Tripode	1	GM00002283	0088381579476	67,00

Foco de iluminación 3.000Lm - DML811

- 3 ajustes de brillo: 3.000 / 1.500 / 750 Lm.
- 3 niveles de iluminancia: 1.800 / 800 / 350 Lx. *
- Clasificación IP65 para resistencia al agua.
- Tiempo de iluminación: 3H en modo alto con BL1860B.
- Ajuste de ángulo de luz: de -30° a 210°.



Dimensiones	Unds.	Código	EAN	P.V.P (€)
249 x 302 x 271 mm	1	DML811	-	294,00



Descripción	Unds.	Código	EAN	P.V.P (€)
Difusor luz DML811	1	GM00002287	-	13,40



Descripción	Unds.	Código	EAN	P.V.P (€)
Difusor luz DML809	1	GM00002286	-	19,55
Tripode de altura ajustable 1,3 m a 2,0 m.		GM00002073	0088381548830	213,00

Foco de mano 1.250LM - DML812

- 3 ajustes de brillo: 600Lm proyector, 1.000Lm lupa y 1.250Lm mixto.
- 3 niveles de iluminancia: 71.000Lx proyector, 500Lx lupa y 51.000Lx mixto. *
- 4 modos de iluminación: proyector, fijo, mixto y estroboscópico.
- Distancia de haz de hasta 640m en modo fijo.
- Temperatura de color de aprox. 5.000K.
- La cabeza de la linterna gira 90°.
- Tiempo de iluminación: 10H en modo proyector con BL1860B.



Dimensiones	Unds.	Código	EAN	P.V.P (€)
313 x 119 x 115 mm	1	DML812	-	149,00

Linterna de mano 100LM - DEAML103

- 1 ajuste de brillo: 100Lm,
- 1 nivel de iluminancia: 240Lx. *
- El tamaño compacto se adapta a la mano.
- Tiempo de iluminación: 28H con BL1041B.



Dimensiones	Unds.	Código	EAN	P.V.P (€)
87 x 64 x 73mm	1	DEAML103	0088381818636	29,00

Linterna de mano - DEBDML186

- 6 luces LED.
- 1 nivel de iluminancia: 500Lx. *
- Tiempo de iluminación: 50H con BL1830B.



Dimensiones	Unds.	Código	EAN	P.V.P (€)
151 x 81 x 61mm	1	DEBDML186	-	24,00

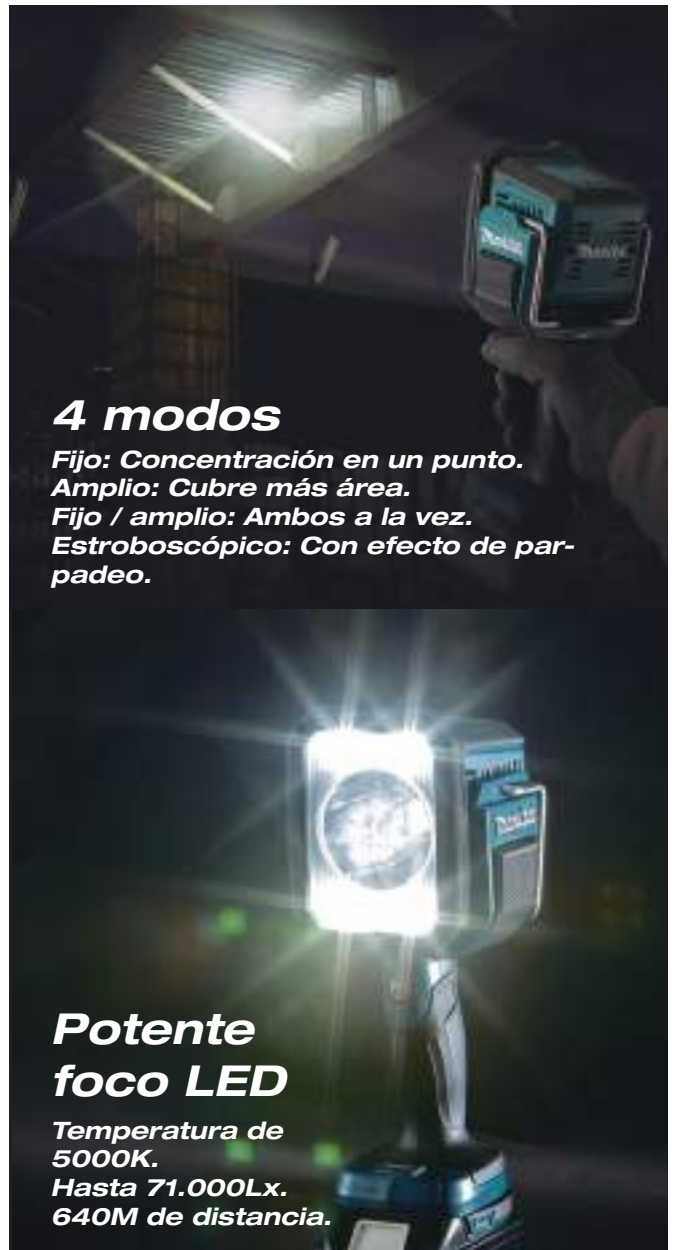

4 modos

- Fijo:** Concentración en un punto.
- Amplio:** Cubre más área.
- Fijo / amplio:** Ambos a la vez.
- Estroboscópico:** Con efecto de parpadeo.

Potente foco LED

- Temperatura de 5000K.**
- Hasta 71.000Lx.**
- 640M de distancia.**

Linterna para cabeza 100LM - DEBDML800

- 1 ajuste de brillo: 100Lm.
- 1 nivel de iluminancia: 2.000Lx. *
- 7 posiciones pivotantes.
- Clasificación IP65 para resistencia al agua.
- Tiempo de iluminación: hasta 20H con BL1830B.



Dimensiones	Unds.	Código	EAN	P.V.P (€)
151 x 76 x 88mm	1	DEBDML800	-	46,00

NUEVA GAMA DE LINTERNAS

Con un tiempo de trabajo superior a los modelos LXT y CXT.
Pensadas para trabajos profesionales de uso prolongado.



Linterna 160LM - ML001G

- 1 ajuste de brillo: 160Lm.
- 1 nivel de iluminancia: 3.000Lx. *
- Cabezal pivotante de 12 posiciones de 0° a 170°.
- Tiempo de iluminación: hasta 55H con BL4040.



Dimensiones	Unds.	Código	EAN	P.V.P (€)
287 x 88 x 136mm	1	ML001G	-	50,00

Linterna 160LM - DEBDML815

- 1 ajuste de brillo: 160Lm.
- 1 nivel de iluminancia: 3.000Lx. *
- Hasta 12 posiciones de cabezal.
- Tiempo de iluminación: hasta 45H con BL1850B.



Dimensiones	Unds.	Código	EAN	P.V.P (€)
272 x 79 x 116mm	1	DEBDML815	-	39,00

Linterna 190LM - DEBML105

- 1 ajuste de brillo: 190Lm.
- 1 nivel de iluminancia: 5.500Lx. *
- Hasta 12 posiciones del cabezal.
- Multirreflector, que controla la dirección.
- Cabezal compacto fabricado en aluminio.
- Tiempo de iluminación: 14H con BL1041B.



Dimensiones	Unds.	Código	EAN	P.V.P (€)
268 x 66 x 93mm	1	DEBML105	0088381836180	60,00

Linterna 190LM - DEADML808

- 1 ajuste de brillo: 190Lm.
- Nivel de iluminancia: de 170 – 4.500Lx. *
- Cabezal pivotante de 12 posiciones de 0° a 170°.
- Con función de zoom que ajusta el rango de iluminación.
- Tiempo de iluminación: 32H con BL1860B.



Dimensiones	Unds.	Código	EAN	P.V.P (€)
297 x 79 x 119mm	1	DEADML808	-	62,00

Linterna 180LM - DEBDML802

- 1 ajuste de brillo: 180Lm.
- 1 nivel de iluminancia: 4.000Lx. *
- Hasta 12 posiciones de cabezal.
- Tiempo de iluminación: hasta 23H con BL1850B.



Dimensiones	Unds.	Código	EAN	P.V.P (€)
272 x 79 x 116mm	1	DEBDML802	0088381675758	55,00

Linterna 190LM - DEAML106

- 1 ajuste de brillo: 190Lm.
- Nivel de iluminancia: 170-4.500Lx. *
- Función zoom que ajusta el rango de iluminación.
- Accesorio magnético opcional.
- Reflector multifacético que se ilumina uniformemente.
- Tiempo de iluminación: 12H con BL1041B.



Dimensiones	Unds.	Código	EAN	P.V.P (€)
290 x 66 x 93mm	1	DEAML106	0088381853125	62,00

Linterna de tubo 710LM - ML002G

- 3 ajustes de brillo: 710Lm "modo 360°", 340Lm modo 180° y 130Lm modo linterna.
- 3 niveles de iluminancia: 340Lx modo 360°, 310Lx modo 180° y 1.900Lx modo linterna. *
- Interruptor con función de apagado automático.
- Con puerto USB integrado.
- Tiempo de iluminación: 16H de luz principal con BL4040B. (Sin uso del USB)



Dimensiones	Unds.	Código	EAN	P.V.P (€)
431 x 86 x 175mm	1	ML002G	-	118,00

Linterna de tubo 710LM - DEAML104

- 3 ajustes de brillo: 710Lm modo 360°, 190Lm modo 180° y 130Lm modo linterna.
- 3 niveles de iluminancia: 340Lx modo 360°, 190Lx modo 180° y 1.900Lx modo linterna. *
- Puerto USB integrado. Gancho retráctil para ser colgada.
- Accesorio magnético opcional para operar con manos libres.
- Tiempo de iluminación: 17H de luz principal con BL1041B. (Sin uso del USB)



Dimensiones	Unds.	Código	EAN	P.V.P (€)
414 x 66 x 132mm	1	DEAML104	0088381836173	102,00

Linterna de faro 500LM - ML006GX

- 3 ajustes de brillo: 500 / 250 / 100 Lm.
- 3 niveles de iluminancia: 800 / 400 / 180 Lx.*
- Cabezal con 7 posiciones.
- Gancho retráctil para ser colgada.
- Tiempo de iluminación: 20H en modo alto con BL4040.



Dimensiones	Unds.	Código	EAN	P.V.P (€)
429 x 82 x 168 mm	1	ML006GX	-	84,00

Linterna de tubo 620LM - DEBDML806

- 3 ajustes de brillo: 620Lm modo 360°, 310Lm modo 180° y 90Lm modo linterna.
- 3 niveles de iluminancia: 310Lx modo 360°, 280Lx modo 180° y 2.100Lx modo linterna. *
- 3 opciones de uso: modo 360°, modo 180° y modo linterna.
- Tiempo de iluminación: 21H en luz principal con BL1850B.



Dimensiones	Unds.	Código	EAN	P.V.P (€)
365 x 78 x 119mm	1	DEBDML806	-	77,00

Linterna de faro 500LM- DML816X

- 3 ajustes de brillo: 500Lm / 250 / 100 Lm.
- 3 niveles de iluminancia: 800 / 400Lx / 180 Lx. *
- Temperatura de color de 5.000K.
- 7 posiciones del cabezal que gira a izquierda y derecha.
- Tiempo de iluminación: 17H en modo alto con BL1860B.



Dimensiones	Unds.	Código	EAN	P.V.P (€)
400 x 79 x 127mm	1	DML816X	-	77,00

Linterna de faro 240LM - DEBDML801

- 2 ajustes de brillo: 240Lm / 120Lm.
- 2 niveles de iluminancia: 400 / 200Lx. *
- Plegable y con gancho giratorio 360°.
- 7 posiciones del cabezal que gira a izquierda y derecha.
- Tiempo de iluminación: 9H en modo full con BL1830B.



Dimensiones	Unds.	Código	EAN	P.V.P (€)
380 x 79 x 116mm	1	DEBDML801	-	48,00

Perforación y Percusión

Inserción SDS - PLUS



Inserción SDS - MAX



Makita Hexagonal 17mm



Makita Hexagonal 19mm



Makita Hexagonal 21mm



Makita Hexagonal 28,6mm



Makita Hexagonal 30mm



B Hexagonal 19mm



K Hexagonal 21mm



MAK 4



MEMES



Brocas SDS-PLUS **NEMESIS II**

Resuelve problemas

Nota: Cuando encontramos varillas en el hormigón armado no hay que apretar. Dejar que la broca vaya cortando con una ligera presión.



4 x 90°, la broca corta de manera uniforme el metal y no se bloquea con las varillas de acero reforzado.



Núcleo de la espiral mejorado. Garantiza bajas vibraciones y una excepcional resistencia a la rotura.



La punta de centrado facilita la perforación del material con una precisión milimétrica.



El diseño simétrico de las 4 espirales aseguran que el desgaste sea bajo y uniforme.



La amplia geometría de las espirales permite un óptimo transporte del polvo del taladrado.

La espiral

Su diseño en espiral de cuatro salidas asegura que la carga de perforación se distribuya uniformemente a lo largo del eje de la broca. El acero de alta calidad y el tratamiento especial de la superficie garantizan la resistencia de la broca.

4 CORTES

Brocas de 5 a 16mm.



Ø (mm)	Largo (mm)	Long. útil (mm)	Unds.	Código	EAN	P.V.P. (€)
5	115	50	1	B-57897	0088381520782	4,95
5	165	100	1	B-57906	0088381520799	5,20
5	215	150	1	B-57912	0088381520805	8,05
5	265	200	1	B-57928	0088381520812	8,30
5,5	115	50	1	B-57940	0088381520836	4,95
5,5	165	100	1	B-57956	0088381520843	5,20
6	115	50	1	B-57962	0088381520850	4,95
6	165	100	1	B-57978	0088381520867	5,20
6	215	150	1	B-57984	0088381520874	6,75
6	265	200	1	B-57990	0088381520881	8,05
6	315	250	1	B-58001	0088381520898	11,15
6,5	165	100	1	B-58023	0088381520911	7,00
6,5	215	150	1	B-58039	0088381520928	9,10
6,5	265	200	1	B-58045	0088381520935	11,40
6,5	315	250	1	B-58051	0088381520942	13,80
7	115	50	1	B-58067	0088381520959	6,25
7	165	100	1	B-58073	0088381520966	7,00
7	215	150	1	B-58089	0088381520973	10,15
8	115	50	1	B-58095	0088381520980	5,70
8	165	100	1	B-58104	0088381520997	5,95
8	215	150	1	B-58110	0088381521000	7,00
8	265	200	1	B-58126	0088381521017	8,30
8	315	250	1	B-58132	0088381521024	11,40
8	465	400	1	B-58154	0088381521048	18,20
9	165	100	1	B-58176	0088381521062	6,50
10	115	50	1	B-58198	0088381521086	5,95
10	165	100	1	B-58207	0088381521093	6,75
10	215	150	1	B-58213	0088381521109	7,55
10	265	200	1	B-58229	0088381521116	8,85
10	315	250	1	B-58235	0088381521123	11,45
10	455	390	1	B-58257	0088381521147	19,20
10	600	540	1	B-58263	0088381521154	26,00
10	1000	940	1	B-58279	0088381521161	63,00
11	160	100	1	E-14495	0088381594097	7,70
11	210	160	1	E-14504	0088381594103	9,25
11	260	210	1	E-14510	0088381594110	10,80
11	310	260	1	E-14526	0088381594127	14,95
12	160	110	1	E-14532	0088381594134	7,20

Brocas de 18 a 32mm.



Ø (mm)	Largo (mm)	Long. útil (mm)	Unds.	Código	EAN	P.V.P. (€)
12	210	160	1	E-14548	0088381594141	8,75
12	260	210	1	E-14554	0088381594158	9,80
12	310	260	1	E-14560	0088381594165	13,90
12	450	400	1	E-14576	0088381594172	21,00
12	600	550	1	B-58372	0088381521260	26,00
12	1000	950	1	B-58388	0088381521277	63,00
14	160	110	1	E-14635	0088381594233	10,30
14	210	160	1	E-14641	0088381594240	13,90
14	260	210	1	E-14657	0088381594257	15,95
14	310	260	1	E-14663	0088381594264	17,00
14	450	400	1	E-14679	0088381594271	22,00
14	600	550	1	E-14685	0088381594288	29,00
14	1000	950	1	B-58497	0088381521383	65,00
15	160	110	1	E-14691	0088381594295	15,95
15	210	160	1	E-14700	0088381594301	18,00
15	260	210	1	E-14716	0088381594318	19,55
15	450	400	1	E-14722	0088381594325	26,00
16	160	110	1	E-14738	0088381594332	16,50
16	210	160	1	E-14744	0088381594349	18,55
16	260	210	1	E-14750	0088381594356	21,00
16	310	260	1	E-14766	0088381594363	23,00
16	450	400	1	E-14772	0088381594370	29,00
16	600	550	1	B-58590	0088381521482	36,00
16	1000	950	1	B-58609	0088381521499	75,00
18	250	200	1	B-58615	0088381521505	27,00
18	450	400	1	B-58621	0088381521512	31,00
20	250	200	1	B-58637	0088381521529	30,00
20	450	400	1	B-58659	0088381521543	36,00
22	250	200	1	B-58665	0088381521550	34,00
22	450	400	1	B-58687	0088381521574	45,00
24	250	200	1	B-58693	0088381521581	43,00
24	450	400	1	B-58702	0088381521598	49,00
25	250	200	1	B-58718	0088381521604	43,00
25	450	400	1	B-58724	0088381521611	54,00
28	250	200	1	B-58746	0088381521635	49,00
28	450	400	1	B-58752	0088381521642	63,00
30	250	200	1	B-58768	0088381521659	55,00
30	450	400	1	B-58774	0088381521666	69,00
32	450	400	1	B-58780	0088381521673	89,00

* A partir de 18mm las brocas son de 3 piezas de carburo.

NUEVA gama de brocas SDS-V-PLUS MAK4.

Para martillos SDS-PLUS. Brocas con cabeza de 4 puntas. Puede taladrar en hormigón armado. Taladros más PRECISOS que con las brocas de 2 puntas. Indicado para todo tipo de trabajos donde se utiliza martillos ligeros SDS-PLUS.

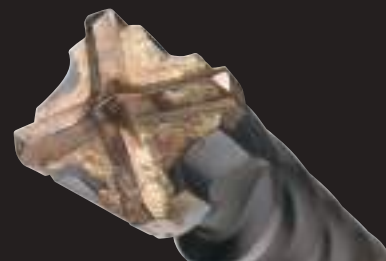

Brocas de 5 a 25mm.



Ø (mm)	Largo (mm)	Long. Útil (mm)	Unds.	Código	EAN	P.V.P. (€)
5	110	50	1	B-68127	0088381544696	2,60
5	160	100	1	B-68133	0088381544702	2,60
6	110	50	1	B-62496	0088381529938	3,15
6	160	100	1	B-62505	0088381529945	3,15
6	210	150	1	B-62511	0088381529952	3,75
6	260	200	1	B-62527	0088381529969	4,05
8	110	50	1	B-62608	0088381530040	3,85
8	160	100	1	B-62614	0088381530057	3,85
8	210	150	1	B-62620	0088381530064	4,40
8	260	200	1	B-62636	0088381530071	4,90
8	310	250	1	B-62642	0088381530088	5,20
10	110	50	1	B-62664	0088381530101	5,15
10	160	100	1	B-62670	0088381530118	5,15
10	210	150	1	B-62686	0088381530125	5,65
10	260	200	1	B-62692	0088381530132	6,20
10	310	250	1	B-62701	0088381530149	6,45
12	160	100	1	B-62739	0088381530170	6,95
12	210	150	1	B-62745	0088381530187	7,45
12	260	200	1	B-62751	0088381530194	8,00
12	310	250	1	B-62767	0088381530200	8,25
12	350	290	1	B-62773	0088381530217	9,25
14	160	100	1	B-62795	0088381530231	10,30
14	210	150	1	B-62804	0088381530248	10,80
14	260	200	1	B-62810	0088381530255	11,35
14	310	250	1	B-62826	0088381530262	11,60
14	350	290	1	B-62832	0088381530279	11,85
16	160	100	1	B-62854	0088381530293	12,35
16	210	150	1	B-62860	0088381530309	12,90
16	260	200	1	B-62876	0088381530316	13,50
16	310	250	1	B-62882	0088381530323	14,65
16	350	290	1	B-62898	0088381530330	15,20
18	260	200	1	B-68177	0088381544740	19,60
18	460	400	1	B-68236	0088381544801	24,00
20	260	200	1	B-68183	0088381544757	25,00
20	460	400	1	B-68242	0088381544818	29,00
22	260	200	1	B-68199	0088381544764	31,00
22	460	400	1	B-68258	0088381544825	38,00
25	260	200	1	B-68208	0088381544771	39,00
25	460	400	1	B-68264	0088381544832	42,00



• **Potencia de rotura.**

Efecto demolición.
Produce microrroturas en el taladrado.
Genera mayor velocidad de taladrado.

• **Reduce la fricción en los laterales para aumentar la velocidad.**



• **Duración en hormigón armado.**

Mayor duración (+35%).
Previene daños en la pastilla cuando golpea en varilla.
Reduce la probabilidad de enganche durante el taladrado.

• **Flauta KVS.**

Geometría cónica de la flauta.
De este modo ofrece gran velocidad y resistencia a la rotura.

• **Pastilla de centrado.**

• **Gran durabilidad.**

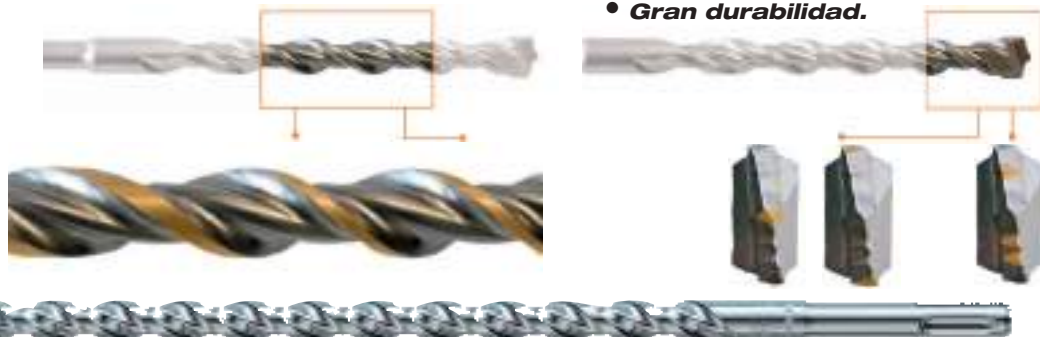

Ø (mm)	Largo (mm)	Long. útil (mm)	Unds.	Código	EAN	P.V.P. (€)
3,5	110	50	1	E-10665	0088381580434	5,70
4	110	50	1	B-47232	0088381454315	3,15
4	160	100	1	B-47248	0088381454322	3,65
4,5	160	100	1	E-10671	0088381580441	5,70
5	110	50	1	B-46492	0088381452427	2,60
5	160	100	1	B-46501	0088381452434	2,85
5,5	110	50	1	B-47298	0088381454377	2,60
5,5	160	100	1	B-47307	0088381454384	3,35
5,5	210	150	1	B-47313	0088381454391	5,95
6	110	50	1	B-46517	0088381452441	2,60
6	160	100	1	B-46523	0088381452458	2,60
6	210	150	1	B-47341	0088381454421	3,90
6	260	200	1	B-47357	0088381454438	4,95
6,5	110	50	1	B-47385	0088381454469	2,85
6,5	160	100	1	B-47391	0088381454476	3,35
6,5	210	150	1	B-47400	0088381454483	4,40
6,5	260	200	1	B-47416	0088381454490	5,95
7	110	50	1	B-47438	0088381454513	2,85
7	160	100	1	B-47444	0088381454520	3,15
7	210	150	1	B-47450	0088381454537	4,70
8	110	50	1	B-46539	0088381452465	2,85
8	160	100	1	B-46545	0088381452472	3,15
8	210	150	1	B-47472	0088381454551	4,15
8	260	200	1	B-47488	0088381454568	5,20
8	400	340	1	B-47503	0088381454582	9,85
8	600	540	1	B-47525	0088381454605	14,55
9	160	100	1	B-47531	0088381454612	3,90
9	210	150	1	B-47547	0088381454629	5,20
9,5	160	100	1	B-47553	0088381454636	4,40
10	110	50	1	B-46551	0088381452489	3,40
10	160	100	1	B-46567	0088381452496	3,65
10	210	150	1	B-47569	0088381454643	4,90
10	260	200	1	B-47575	0088381454650	5,70
10	310	250	1	B-47581	0088381454667	6,50
10	450	390	1	B-47606	0088381454681	10,90

Ø (mm)	Largo (mm)	Long. útil (mm)	Unds.	Código	EAN	P.V.P. (€)
10	600	540	1	B-47612	0088381454698	15,05
10	1000	940	1	B-47634	0088381454711	38,00
11	160	110	1	B-47640	0088381454728	5,45
11	210	160	1	B-47656	0088381454735	6,00
11	260	210	1	B-47662	0088381454742	7,25
12	160	110	1	B-46573	0088381452502	4,40
12	210	160	1	B-47684	0088381454766	5,45
12	260	210	1	B-47690	0088381454773	6,75
12	310	260	1	B-47709	0088381454780	8,60
12	450	400	1	B-47721	0088381454803	11,95
12	600	550	1	B-47737	0088381454810	15,60
12	1000	950	1	B-47759	0088381454834	41,00
13	160	110	1	B-47765	0088381454841	5,45
13	210	160	1	B-47771	0088381454858	6,25
13	260	210	1	B-47787	0088381454865	7,25
13	310	260	1	B-47793	0088381454872	9,35
14	160	110	1	B-46589	0088381452519	6,00
14	210	160	1	B-47802	0088381454889	6,75
14	260	210	1	B-47818	0088381454896	8,35
14	310	260	1	B-47824	0088381454902	9,35
14	450	400	1	B-47830	0088381454919	14,55
14	600	550	1	B-47846	0088381454926	17,15
14	1000	950	1	B-47852	0088381454933	42,00
15	160	110	1	B-47868	0088381454940	7,55
15	210	160	1	B-47874	0088381454957	8,80
15	260	210	1	B-47880	0088381454964	9,60
15	450	400	1	B-47896	0088381454971	15,10
16	160	110	1	B-47905	0088381454988	7,30
16	210	160	1	B-47911	0088381454995	8,85
16	310	260	1	B-47933	0088381455015	11,45
16	450	400	1	B-47949	0088381455022	17,15
16	600	550	1	B-47955	0088381455039	21,00
16	800	750	1	B-47961	0088381455046	31,00
16	1000	950	1	B-47977	0088381455053	48,00
17	210	160	1	B-47983	0088381455060	13,50

Brocas SDS-PLUS StandMak



Ø (mm)	Largo (mm)	Long. útil (mm)	Unds.	Código	EAN	P.V.P. (€)
3,5	110	50	1	D-15665	0088381170079	1,15
4	110	50	1	D-00016	0088381169004	1,20
5	110	50	1	D-00022	0088381169011	1,20
5	160	100	1	D-00038	0088381169028	1,20
5,5	110	50	1	D-00044	0088381169035	1,20
5,5	160	100	1	D-16106	0088381187381	1,20
6	110	50	1	D-00050	0088381169042	1,20
6	160	100	1	D-00066	0088381169059	1,20
6	210	150	1	D-00072	0088381169066	1,50
6,5	110	50	1	D-00088	0088381169073	1,20
6,5	160	100	1	D-00094	0088381169080	1,20
7	110	50	1	D-00103	0088381169097	1,20
7	160	100	1	D-00119	0088381169103	1,20
8	110	50	1	D-00125	0088381169110	1,20
8	160	100	1	D-00131	0088381169127	1,20
8	210	150	1	D-00147	0088381169134	1,50
8	260	200	1	D-00153	0088381169141	1,85
9	160	100	1	D-08056	0088381182379	1,50
9	210	150	1	D-00169	0088381169158	1,50
9,5	210	150	1	D-03274	0088381173520	1,50
10	160	100	1	D-00175	0088381169165	1,50
10	210	150	1	D-00181	0088381169172	1,80
10	260	200	1	D-00197	0088381169189	1,80
10	310	250	1	D-00206	0088381169196	2,40
10	460	400	1	D-17538	0088381196574	4,25
12	160	100	1	D-00228	0088381169219	1,50
12	210	150	1	D-00234	0088381169226	1,80
12	260	200	1	D-00240	0088381169233	1,80
12	460	400	1	D-16271	0088381187558	4,55
13	160	100	1	D-00256	0088381169240	1,75
13	350	290	1	D-16128	0088381187404	2,75
14	160	100	1	D-00262	0088381169257	1,85
14	260	200	1	D-00278	0088381169264	2,45
14	460	400	1	D-17544	0088381196581	4,90
16	210	150	1	D-00290	0088381169288	3,45
16	310	250	1	D-00309	0088381169295	4,25
16	460	400	1	D-16287	0088381187565	5,75
18	210	150	1	D-00321	0088381169318	3,35
18	300	240	1	D-00337	0088381169325	4,30
18	460	400	1	D-17566	0088381196604	6,70
20	210	150	1	D-00359	0088381169349	4,25
20	310	250	1	D-00365	0088381169356	6,95
20	460	400	1	D-15235	0088381186339	7,20
22	260	200	1	D-00371	0088381169363	5,50

Ø (mm)	Largo (mm)	Long. útil (mm)	Unds.	Código	EAN	P.V.P. (€)
22	310	250	1	D-08062	0088381182386	6,65
22	460	400	1	D-15241	0088381186346	7,95
24	460	400	1	D-16302	0088381187589	9,10
25	260	200	1	D-00387	0088381169370	7,20
25	310	250	1	D-08517	0088381182454	8,55
25	460	400	1	D-15257	0088381186353	10,40
26	260	200	1	D-00393	0088381169387	9,80
26	460	400	1	D-15263	0088381186360	11,55
28	460	400	1	D-16318	0088381187596	16,45
30	460	400	1	D-17572	0088381196611	19,90

Brocas SDS-PLUS StandMak



- Cajas de 25 unidades.



* Presentadas en caja de cartón. Brocas sueltas.

Ø (mm)	Largo (mm)	Long. útil (mm)	Unds.	Código	EAN	P.V.P. (€)
5	110	50	25	D-01155-25	0088381170598	21,65
6	110	50	25	D-01161-25	0088381170604	23,00
6	160	100	25	D-01177-25	0088381170611	28,00
8	160	100	25	D-01183-25	0088381170628	28,00
8	210	150	25	D-01199-25	0088381170635	35,00
10	160	100	25	D-01208-25	0088381170642	28,00
10	210	150	25	D-03707-25	0088381173995	38,00
12	160	100	25	D-03713-25	0088381174008	34,00
12	210	150	25	D-03729-25	0088381174015	38,00



Estuche SDS-PLUS Némesis (7 piezas)



NEMESIS II



Ø (mm)	Largo (mm)	Long. útil (mm)	Unds.	Código	EAN	P.V.P. (€)
5	110	50	1	E-14928	-	48,00
6	110	50	1			
8	110	50	1			
6	160	100	1			
8	160	100	1			
10	160	100	1			
12	160	100	1			



Estuche SDS-PLUS Némesis (3 piezas)

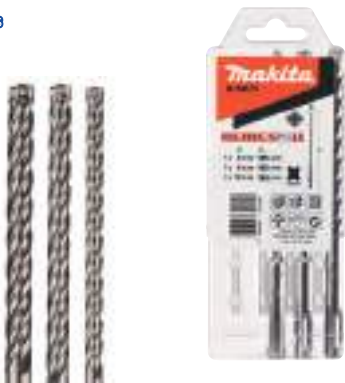

NEMESIS II



Ø (mm)	Largo (mm)	Long. útil (mm)	Unds.	Código	EAN	P.V.P. (€)
6	160	100	1	B-59075	0088381521963	19,20
8	160	100	1			
10	160	100	1			

Estuche SDS-V-PLUS (13 piezas)



MAK 4



Ø (mm)	Largo (mm)	Long. útil (mm)	Unds.	Código	EAN	P.V.P. (€)
6	110	50	1	B-64674	0088381535762	88,00
6	160	100	1			
7	110	50	1			
7	160	100	1			
8	110	50	1			
8	160	100	1			
10	110	50	1			
10	160	100	1			
12	160	100	1			
14	160	100	1			
16	160	100	1			
Puntero 250 mm			1			
Cinzel 20 x 250 mm			1			

Estuche SDS-V-PLUS (5 piezas)



MAK 2



Ø (mm)	Largo (mm)	Long. útil (mm)	Unds.	Código	EAN	P.V.P. (€)
5	110	50	1	B-49052	0088381457460	14,55
6	110	50	1			
8	110	50	1			
6	160	100	1			
8	160	100	1			

Estuche V-PLUS (7 piezas)



MAK 2



Ø (mm)	Largo (mm)	Long. útil (mm)	Unds.	Código	EAN	P.V.P. (€)
5	110	50	1	B-49046	0088381457453	29,00
6	110	50	1			
8	110	50	1			
6	160	100	1			
8	160	100	1			
10	160	100	1			
12	160	100	1			

Estuche V-PLUS (3 piezas)



MAK 2



Ø (mm)	Largo (mm)	Long. útil (mm)	Unds.	Código	EAN	P.V.P. (€)
5	110	50	1	B-49052	0088381457460	14,55
6	110	50	1			
8	110	50	1			
6	160	100	1			
8	160	100	1			

Estuche SDS-PLUS StandMak (4 piezas)



Ø (mm)	Largo (mm)	Long. útil (mm)	Unds.	Código	EAN	P.V.P. (€)
6,5	160	100	1	D-74728	-	8,25
8	160	100	1			
10	160	100	1			
12	160	100	1			
5	110	50	1	D-74136	0088381587174	8,25
6	160	100	1			
8	160	100	1			
10	160	100	1			



Estuche SDS-PLUS StandMak (5 piezas)



Ø (mm)	Largo (mm)	Long. Útil (mm)	Unds.	Código	EAN	P.V.P. (€)
5	110	50	1	D-00795	0088381171182	5,45
6	110	50	1			
8	110	50	1			
6	160	100	1			
8	160	100	1			

Set de demolición y brocas Standmak



Ø (mm)	Largo (mm)	Long. Útil (mm)	Unds.	Código	EAN	P.V.P. (€)
5	110	50	1	D-19180	0088381253826	56,00
6	110	50	1			
8	110	50	1			
10	110	100	1			
6	160	100	1			
8	160	100	1			
10	160	100	1			
12	160	100	1			
8	210	140	1			
10	210	140	1			
12	260	175	1			
14	260	175	1			
Puntero 14 x 140mm			1			
Puntero 14 x 250mm			1			
Cinzel 20 x 140mm			1			
Cinzel 20 x 250mm			1			
Espátula 40 x 250mm			1			

Brocas de corona SDS-PLUS



Ø (mm)	Largo (mm)	Unds.	Código	EAN	P.V.P. (€)
40	60	1	P-26191	0088381953092	41,00
50	60	1	P-26200	0088381953108	54,00
65	60	1	P-26216	0088381953115	55,00
80	60	1	P-26222	0088381953122	61,00

Broca de centrado

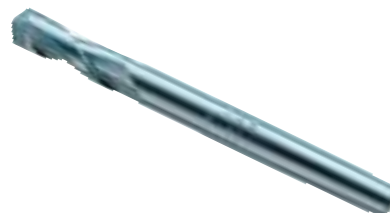

Ø (mm)	Largo (mm)	Punta	Unds.	Código	EAN	P.V.P. (€)
8	120	TCT	1	P-64347	0088381994866	6,25

Adaptador



Rosca (mm)	Largo (mm)	Unds.	Código	EAN	P.V.P. (€)
M16	105	1	P-67745	0088381998277	21,00
M16	370	1	P-67751	0088381998284	32,00



Brocas de corona para mampostería



Ø (mm)	Largo (mm)	Unds.	Código	EAN	P.V.P. (€)
30	50	1	D-73891	0088381586801	7,20
35	50	1	D-73900	0088381586818	7,70
40	50	1	D-73916	0088381586825	8,00
50	50	1	D-73922	0088381586832	9,30
68	50	1	D-73938	0088381586849	12,10
82	50	1	D-73944	0088381586856	16,50
90	50	1	D-73950	0088381586863	19,55
100	50	1	D-73966	0088381586870	22,00

Set de broca + adaptador



Ø (mm)	Largo (mm)	Unds.	Código	EAN	P.V.P. (€)
68	175	1	D-74011	0088381586924	17,50
82	175	1	D-74027	0088381586931	22,00

Broca de centrado



Ø (mm)	Largo (mm)	Unds.	Código	EAN	P.V.P. (€)
8	110	1	D-73972	0088381586887	1,65

Adaptadores



Ø (mm)	Largo (mm)	Unds.	Código	EAN	P.V.P. (€)
110	110	1	D-73988	0088381586894	3,90
200	200	1	D-73994	0088381586900	5,90
350	350	1	D-74005	0088381586917	8,25



Más precisión, menos vibración, mayor poder de taladrado.

- Tres piezas de carburo con geometría de corte única.

Ángulo de pastilla cambiado.



Pastilla biselada en diferentes puntos.

MAK 4

- Renovada geometría de la broca 4x90° que evita enganches de la pastilla de carburo en hormigones reforzados. Pastillas laterales muy robustas con forma de corte curva que apoyan a la pastilla central en los cortes rápidos.
- Punta de centrado de 130° para facilitar el inicio del taladrado y garantiza una guía perfecta.
- Cada pastilla lateral lleva marcada una línea que indica el desgaste, así podemos evaluar la precisión de los agujeros de anclaje.
- Pastillas de carburo perfectamente soldadas al cuerpo de acero de la broca.
- Punta de carburo de grandes dimensiones con tecnología patentada de biselado lateral* para un óptimo taladrado en hormigón reforzado.

*A partir de ø32mm.

- El diseño de la cabeza de la broca le proporciona una gran dureza, lo que facilita un agresivo efecto de demolición y una alta velocidad de taladrado.
- Diseño de la espiral patentado, con un óptimo rendimiento entre extracción del polvo y resistencia a la rotura.



Ø (mm)	Largo (mm)	Long. útil (mm)	Unds.	Código	EAN	P.V.P. (€)
16	340	200	1	P-77730	0088381708487	36,00
16	540	400	1	P-77746	0088381708494	43,00
16	1320	1180	1	P-77768	0088381708517	151,00
18	340	200	1	P-77774	0088381708524	41,00
18	540	400	1	P-77780	0088381708531	45,00
18	1320	1180	1	P-77805	0088381708555	154,00
20	320	200	1	P-77811	0088381708562	41,00
20	520	400	1	P-77827	0088381708579	47,00
20	920	800	1	P-77833	0088381708586	68,00
22	320	200	1	P-77855	0088381708609	46,00
22	520	400	1	P-77861	0088381708616	50,00
22	920	800	1	P-77877	0088381708623	72,00
22	1320	1200	1	P-77883	0088381708630	167,00
24	320	200	1	P-77899	0088381708647	49,00
24	520	400	1	P-77908	0088381708654	56,00
25	320	200	1	P-77914	0088381708661	48,00
25	520	400	1	P-77920	0088381708678	56,00
25	920	800	1	P-77936	0088381708685	84,00
26	520	400	1	P-77958	0088381708708	61,00
28	370	250	1	P-77964	0088381708715	53,00

Ø (mm)	Largo (mm)	Long. útil (mm)	Unds.	Código	EAN	P.V.P. (€)
28	570	450	1	P-77970	0088381708722	64,00
28	670	550	1	P-77986	0088381708739	82,00
28	920	800	1	P-77992	0088381708746	98,00
28	1320	1200	1	P-78003	0088381708753	183,00
30	370	250	1	P-78019	0088381708760	59,00
30	570	450	1	P-78025	0088381708777	69,00
32*	370	250	1	P-78031	0088381708784	61,00
32*	570	450	1	P-78047	0088381708791	74,00
32*	920	800	1	P-78053	0088381708807	112,00
35	370	250	1	P-78075	0088381708821	73,00
35	570	450	1	P-78081	0088381708838	84,00
35	670	550	1	P-78097	0088381708845	102,00
38	370	250	1	P-78134	0088381708883	88,00
38	570	450	1	P-78140	0088381708890	104,00
40	370	250	1	P-78156	0088381708906	104,00
40	570	450	1	P-78162	0088381708913	125,00
40	920	800	1	P-78178	0088381708920	167,00
40	1320	1200	1	P-78184	0088381708937	228,00
45	570	450	1	P-78190	0088381708944	177,00
50	570	450	1	P-78215	0088381708968	201,00



★★★

Ø (mm)	Largo (mm)	Long. útil (mm)	Unds.	Código	EAN	P.V.P. (€)
12	340	200	1	E-11324	0088381582605	11,65
12	540	400	1	E-11330	0088381582612	16,10
14	340	200	1	E-11346	0088381582629	14,45
14	540	400	1	E-11352	0088381582636	18,35
16	340	200	1	E-11368	0088381582643	17,20
16	540	400	1	E-11374	0088381582650	21,10
18	340	200	1	E-11380	0088381582667	23,00
18	540	400	1	E-11396	0088381582674	27,00

Ø (mm)	Largo (mm)	Long. útil (mm)	Unds.	Código	EAN	P.V.P. (€)
20	340	220	1	E-11405	0088381582681	27,00
20	540	420	1	E-11411	0088381582698	33,00
22	340	220	1	E-11427	0088381582704	32,00
22	540	420	1	E-11433	0088381582711	37,00
24	340	220	1	E-11449	0088381582728	36,00
24	540	420	1	E-11455	0088381582735	42,00
25	340	220	1	E-11461	0088381582742	37,00
25	540	420	1	E-11477	0088381582759	43,00
28	370	250	1	E-11483	0088381582766	47,00
28	570	450	1	E-11499	0088381582773	57,00
30	370	250	1	E-11508	0088381582780	57,00
30	570	450	1	E-11514	0088381582797	70,00

Brocas SDS-MAX



4 ventajas significativas:

1. Mayor vida útil a la broca.
2. Velocidad de perforación superior a la de las brocas convencionales.
3. Rápida eliminación del polvo del taladro = ahorro de tiempo y dinero.
4. Menos vibraciones y energía directamente a la punta de la broca = menos esfuerzo.

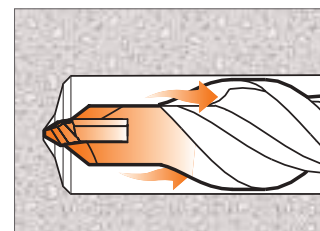

Brocas MAK2



MAK 2

Ø (mm)	Largo (mm)	Long. útil (mm)	Unds.	Código	EAN	P.V.P. (€)
12	340	200	1	P-17033	0088381943369	31,00
12	540	400	1	P-17049	0088381943376	39,00
12	690	550	1	P-17055	0088381943383	55,00
14	340	200	1	P-17077	0088381943406	35,00
14	540	400	1	P-17083	0088381943413	42,00
15	340	200	1	P-17108	0088381943437	35,00
15	540	400	1	P-17114	0088381943444	43,00



Brocas 2C Standard



RAPIDEZ DE TALADRADO

- Soldadura extremadamente resistente entre el carburo de tungsteno y el acero, lo que hace a la broca muy resistente.
- Núcleo reforzado para una mejor absorción de la vibración y una mejor transmisión de la fuerza a la punta de la broca.
- Voluminosa espiral de dos hélices ideal para un desalojo rápido del material perforado, como en ambientes húmedos, como por ejemplo perforaciones en la minería o piedra natural.

Ø (mm)	Largo (mm)	Long. útil (mm)	Unds.	Código	EAN	P.V.P. (€)
14	340	200	1	P-70655	0088381701235	27,00
14	540	400	1	P-70661	0088381701242	34,00
16	340	200	1	P-70677	0088381701259	32,00
16	540	400	1	P-70683	0088381701266	36,00
18	340	200	1	P-70699	0088381701273	34,00
18	540	400	1	P-70708	0088381701280	38,00
20	320	200	1	P-70714	0088381701297	35,00
20	520	400	1	P-70720	0088381701303	39,00
22	320	200	1	P-70736	0088381701310	37,00
22	520	400	1	P-70742	0088381701327	42,00
24	320	200	1	P-70758	0088381701334	41,00
24	520	400	1	P-70764	0088381701341	47,00
25	320	200	1	P-70770	0088381701358	42,00
25	520	400	1	P-70786	0088381701365	47,00

Ø (mm)	Largo (mm)	Long. útil (mm)	Unds.	Código	EAN	P.V.P. (€)
28	370	250	1	P-70792	0088381701372	48,00
28	570	450	1	P-70801	0088381701389	54,00
30	370	250	1	P-70817	0088381701396	48,00
30	570	450	1	P-70823	0088381701402	57,00
32	370	250	1	P-70839	0088381701419	50,00
32	570	450	1	P-70845	0088381701426	61,00
35	370	250	1	P-70851	0088381701433	60,00
35	570	450	1	P-70867	0088381701440	71,00
38	370	250	1	P-70873	0088381701457	71,00
38	570	450	1	P-70889	0088381701464	81,00
40	370	250	1	P-70895	0088381701471	84,00
40	570	450	1	P-70904	0088381701488	101,00

Brocas de corona SDS-MAX



**BROCAS DE CORONA
IDEALES PARA TALADRAR HORMIGÓN Y MAMPOSTERÍA:**

- Alineación del diente asimétrica.
- Espiral externa que reduce el peso un 8%.
- Espesor de la pared del diente reducida y diente biselado en la corona para una mejor penetración en el material.
- Dos ranuras asimétricas para evacuar el polvo.



Brocas de corona SDS-MAX



Ø (mm)	Largo (mm)	Unds.	Código	EAN	P.V.P. (€)
40	100	1	P-03779	0088381917438	85,00
50	100	1	P-03785	0088381917445	89,00
65	100	1	P-03791	0088381917452	108,00
80	100	1	P-03800	0088381917469	122,00
90	100	1	P-03816	0088381917476	144,00
100	100	1	P-03822	0088381917483	166,00
125	100	1	P-16374	0088381932394	240,00



Broca de centrado SDS-MAX



Ø (mm)	Largo (mm)	Unds.	Código	EAN	P.V.P. (€)
11	120	1	P-03838	0088381917490	9,35

Adaptadores



Tipo	Largo (mm)	Unds.	Código	EAN	P.V.P. (€)
Cónico	180	1	P-16994	0088381943321	43,00
Cónico	450	1	P-17005	0088381943338	60,00

Cuña



Unds.	Código	EAN	P.V.P. (€)
1	P-03763	0088381944960	8,80

Brocas de campana SDS-MAX



Para el empleo en hormigón, mampostería y piedra natural.:

Brocas de campana Makita, es el instrumento moderno para los usuarios profesionales. Una broca de corazón poderoso, desarrollado para la última generación de martillos rotativos, garantiza un taladrado eficiente y una vida superior.

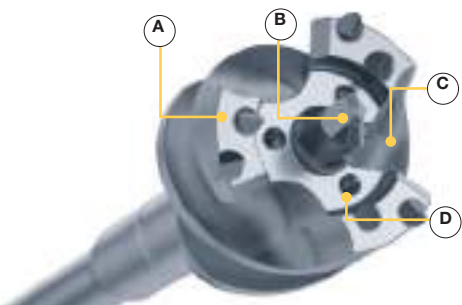

- (A) Dientes de carburo con forma de cincel para una rápida penetración del hormigón.
- (B) Punta central para mayor precisión.
- (C) Tres salidas para retirar grandes cantidades de polvo y desechos.
- (D) Tres dientes de carburo adicionales para demoler las piedras más pequeñas.

- **Menos vibración.**
- **Más ligeras.**
- **Tratamiento especial contra el calor que incrementa la duración de la broca.**
- **Construcción de una sola pieza para una transmisión perfecta de la fuerza.**

Ø (mm)	Largo (mm)	Unds.	Código	EAN	P.V.P. (€)
45	550	1	B-57635	0088381519878	185,00
45	990	1	B-57641	0088381519885	218,00
55	550	1	B-57657	0088381519892	219,00
55	990	1	B-57663	0088381519908	246,00

Ø (mm)	Largo (mm)	Unds.	Código	EAN	P.V.P. (€)
65	550	1	B-57679	0088381519915	230,00
65	990	1	B-57685	0088381519922	273,00
80	550	1	B-57691	0088381519939	254,00
80	990	1	B-57700	0088381519953	337,00

Brocas de campana modulares

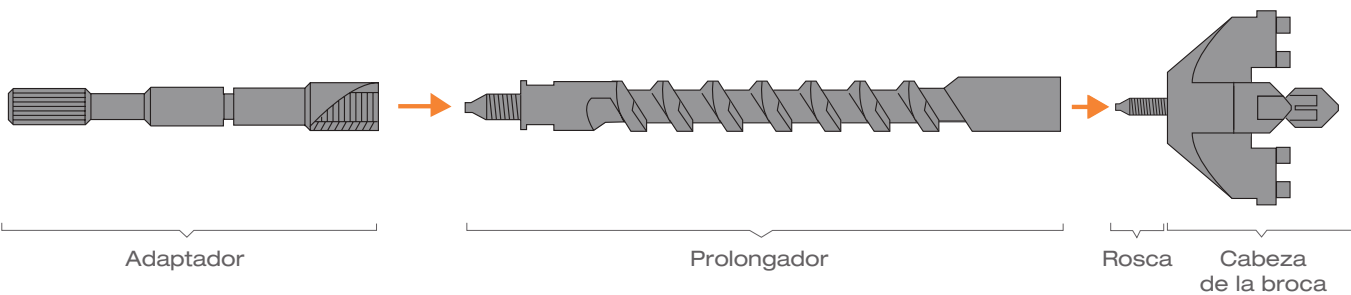

Adaptadores

Tipo	Largo (mm)	Unds.	Código	EAN	P.V.P. (€)
SDS-MAX	195	1	P-03888	0088381917544	56,00
B	175	1	P-03894	0088381917551	47,00

Prolongador

Ø (mm)	Largo (mm)	Unds.	Código	EAN	P.V.P. (€)
25	280	1	P-03925	0088381917582	91,00

Rosca con muelle para cabeza

Ø (mm)	Largo (mm)	Unds.	Código	EAN	P.V.P. (€)
	50	1	P-03931	0088381917599	21,00

Cabeza de broca

Ø (mm)	Largo (mm)	Modelo	Unds.	Código	EAN	P.V.P. (€)
35	150	HR4003C HR4013C	1	P-04008	0088381945028	129,00
40	150		1	P-03844	0088381917506	136,00
50	150		1	P-03850	0088381917513	166,00
55	150		1	P-04014	0088381945035	183,00
60	150	HR4003C HR4013C HR4501C HR4511C HR5202C HR5212C	1	P-04020	0088381945042	187,00
68	150		1	P-03866	0088381917520	206,00
80	150		1	P-03872	0088381917537	262,00
90	150		1	P-04036	0088381945059	370,00



P-03931

MAK - Conexión SDS-MAX

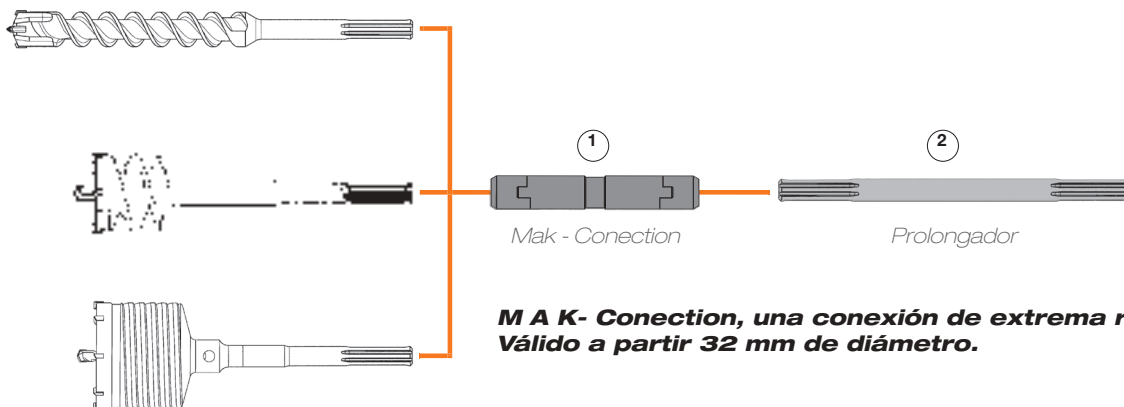

MAK-Connection, una conexión de extrema robustez. Válido a partir 32 mm de diámetro.



Sistema de conexión para brocas, MAK-Connection. Una revolución en el universo del taladrado.

Ventajas del sistema MAK-Connection:

- El sistema SDS - MAX, MAK-Connection, permite una conexión segura y rápida entre la broca y el adaptador.
- Sin pérdidas de energía, contrariamente a los sistemas existentes. La totalidad de la potencia es transmitida a la broca.

Cambios de inserción



Descripción	Longitud (mm)	Accesorio	Unds.	Código	EAN	P.V.P. (€)
Mak-Connection	-	SDS-MAX	1	P-53914	0088381984423	191,00
Prolongador	320		1	P-53920	0088381984430	27,00
Prolongador	750		1	P-53936	0088381984447	34,00
Prolongador	1100		1	P-53942	0088381984454	47,00

Descripción	Máquina	Accesorio	Unds.	Código	EAN	P.V.P. (€)
Adaptador	K	SDS-MAX	1	P-02319	0088381944953	147,00
Adaptador	SDS-MAX	SDS-PLUS	1	P-17027	0088381943352	74,00



Makita

XGT X2
80V_{max}



**Sistemas
de aspiración
para martillos.**



XGT
40V_{max} Li-ion

SDS-PLUS

Punteros



- Para todo tipo de obras en mampostería, hormigón y piedra suelta.



B-64238

Ancho (mm)	Largo (mm)	Serie	Unds.	Código	EAN	P.V.P. (€)
14	250	Premium ★★★★★	1	B-64238	0088381534444	11,40
14	250	Long life ★★★	1	B-64294	0088381534505	7,80
14	250	Standard ★★	1	D-08713	0088381179522	3,80

Cinceles



- Para todo tipo de obras en mampostería, hormigón y piedra suelta.



B-64244

Ancho (mm)	Largo (mm)	Serie	Unds.	Código	EAN	P.V.P. (€)
20	250	Premium ★★★★★	1	B-64244	0088381534451	11,40
20	250	Long life ★★★	1	B-64303	0088381534512	7,80
20	250	Standard ★★	1	D-08729	0088381179539	3,65

Espátulas



- Para la demolición universal en materiales de mayor volumen.



B-64250

Ancho (mm)	Largo (mm)	Serie	Unds.	Código	EAN	P.V.P. (€)
40	250	Premium ★★★★★	1	B-64250	0088381534468	16,60
40	250	Long life ★★★	1	B-64319	0088381534529	11,45
40	250	Standard ★★	1	D-08735	0088381179546	4,90
50	215	Standard ★★	1	D-25616	0088381338431	5,20

Espátula para asfalto



- Para la obra en carretera, por ejemplo, en el saneamiento de superficies u otras reparaciones de calzada.



P-24935

Ancho (mm)	Largo (mm)	Serie	Unds.	Código	EAN	P.V.P. (€)
60	250	Long life ★★★	1	P-24935	0088381951845	17,00

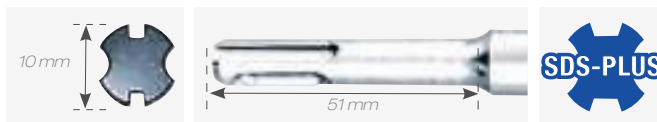

Espátula dentada



- Para sanear muros, eliminar masilla de juntas.



P-25096

Ancho (mm)	Largo (mm)	Serie	Unds.	Código	EAN	P.V.P. (€)
32	200	Long life ★★★	1	P-25096	0088381952002	65,00

Espátulas curvas



- Retirada de azulejos de forma fácil y sencilla (con extremo acodado de forma ergonómica).



P-24941

Ancho (mm)	Largo (mm)	Serie	Unds.	Código	EAN	P.V.P. (€)
40	200	Long life	1	P-24941	0088381951852	12,90
60	250	★★★	1	P-24957	0088381951869	18,00

Escoplos



- Para acanalar en mampostería.



P-05533

Ancho (mm)	Largo (mm)	Serie	Unds.	Código	EAN	P.V.P. (€)
22	250	Long life	1	P-05533	0088381921329	14,95
22	240	★★★	1	P-25080	0088381951999	13,90

Escoplo acanalado con aletas



- Para tratamiento de piedra caliza, hormigón, ladrillos, piedra pómez, especialmente efectivo y seguro debido a su profundidad de acanalado variable de 10-35 mm. sin resbalar hacia el interior del surco.



P-24963

Ancho (mm)	Largo (mm)	Serie	Unds.	Código	EAN	P.V.P. (€)
22	250	Long life ★★★	1	P-24963	0088381951876	26,00

SDS-PLUS

Formones



- Para trabajos de carpintería en general, rápido arranque de material de madera blanda, por ejemplo para arrancar marcos de ventanas viejos.

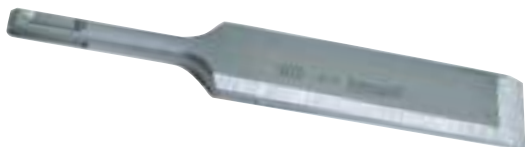

P-25111

Ancho (mm)	Largo (mm)	Serie	Unds.	Código	EAN	P.V.P. (€)
20	170	Long life	1	P-25105	0088381952019	18,55
30	170	★★★	1	P-25111	0088381952026	25,00

Set de demolición



Contenido	Unds.	Código	EAN	P.V.P. (€)
Puntero 14 x 250mm	1	D-05181	0088381177450	24,00
Cinzel 20 x 250mm	1			
Espátula 40 x 250mm	1			

Raspador



- Para levantar moquetas y retirar pegamentos de superficies rígidas.



A-68161

Ancho (mm)	Descrip.	Tipo	Unds.	Código	EAN	P.V.P. (€)
100	Raspador	-	1	A-68161	0088381537254	80,00
-	Cuchilla	Para A-68161	1	343411-9	0088381118415	29,00

Set de demolición



Contenido	Unds.	Código	EAN	P.V.P. (€)
Puntero 14 x 250mm	2	D-16368	0088381187848	35,00
Cinzel 20 x 250mm	2			
Espátula 40 x 250mm	1			

Set de demolición



Contenido	Unds.	Código	EAN	P.V.P. (€)
Puntero 250mm	1	D-42357	0088381404815	30,00
Cinzel 20 x 250mm	1			
Espátula 40 x 250mm	1			



SDS-MAX

Punteros



- Para todo tipo de obras en mampostería, hormigón y piedra suelta.



B-10366

Ancho (mm)	Largo (mm)	Serie	Unds.	Código	EAN	P.V.P. (€)
18	280	Long life ★★★	1	P-16237	0088381932264	8,00
18	400		1	P-16243	0088381932271	11,85
18	600		1	P-16259	0088381932288	15,70
18	300	Standard ★★	1	D-34176	0088381364836	5,80
18	400		1	D-34182	0088381364843	7,25
18	400		10	D-34182-10	0088381367240	66,00
18	600		1	D-34198	0088381364850	9,30
18	400	Autoafilable ★★★★	1	B-10366	0088381342469	12,35
18	400	Autoafilable espiral ★★★★	1	B-23064	0088381406161	19,60

Cinceles



- Para todo tipo de obras de mampostería, hormigón y piedra suelta.



P-16265

Ancho (mm)	Largo (mm)	Serie	Unds.	Código	EAN	P.V.P. (€)
25	280	Long life ★★★	1	P-16265	0088381932295	8,00
25	400		1	P-16271	0088381932301	11,85
25	600		1	P-16287	0088381932318	15,70
25	300	Standard ★★	1	D-34207	0088381364867	5,80
25	400		1	D-34213	0088381364874	7,55
25	400		10	D-34213-10	0088381367257	71,00
25	600		1	D-34229	0088381364881	9,00

Set de cinceles y espátulas 5 + 5



Ancho (mm)	Largo (mm)	Serie	Unds.	Código	EAN	P.V.P. (€)
18	400	Standard ★★	5	D-35324-10	0088381367905	53,00
25	400		5			

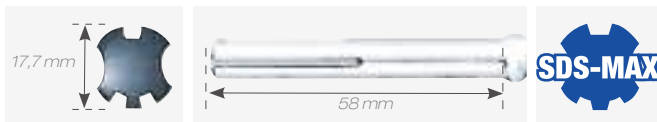

Espátulas



- Para la demolición en material de mayor volumen.



P-16302

Ancho (mm)	Largo (mm)	Serie	Unds.	Código	EAN	P.V.P. (€)
50	350	Long life ★★★	1	P-16302	0088381932332	15,95
80	300		1	P-16318	0088381932349	24,00
50	400	Standard ★★	1	D-34235	0088381364898	8,25
80	300		1	D-34241	0088381364904	13,35

Espátula curva



- Retirada de azulejos de forma fácil y sencilla. Con extremo acodado de forma ergonómica.



P-16324

Ancho (mm)	Largo (mm)	Serie	Unds.	Código	EAN	P.V.P. (€)
50	300	Long life ★★★	1	P-16324	0088381932356	24,00

Espátula dentada



- Para sanear muros, por ejemplo, para eliminar ma-silla de juntas.



P-16346

Ancho (mm)	Largo (mm)	Serie	Unds.	Código	EAN	P.V.P. (€)
38	280	Long life ★★★	1	P-16346	0088381932370	62,00

Escoplo



- Para acanalar en mampostería.



P-16293

Ancho (mm)	Largo (mm)	Serie	Unds.	Código	EAN	P.V.P. (€)
26	300	Long life ★★★	1	P-16293	0088381932325	25,00

SDS-MAX

Escoplo acanalado con aletas



- Para acanalar en piedra caliza, hormigón, ladrillos, piedra pómez, especialmente efectivo y seguro debido a su profundidad de acanalado variable de 10-35 mm. sin resbalar hacia el interior del surco.



Ancho (mm)	Largo (mm)	Serie	Unds.	Código	EAN	P.V.P. (€)
35	380	Long life ★★★	1	P-16330	0088381932363	49,00

Pala



- Perfecta para sacar tierra.



Ancho (mm)	Largo (mm)	Serie	Unds.	Código	EAN	P.V.P. (€)
110	400	Long life ★★★	1	P-23721	0088381950664	49,00

Pisón



- Para compactar materiales blandos.



Adaptador



Pisón

Ø (mm)	Descripción	Serie	Unds.	Código	EAN	P.V.P. (€)
140	Pisón	Long life	1	A-19875	0088381158985	83,00
-	Adaptador pisón	★★★	1	A-19897	0088381159005	40,00

Bujarda



- Para abujardar zonas de piedra u hormigón.



Adaptador



Base

Medida (mm)	Descripción	Serie	Unds.	Código	EAN	P.V.P. (€)
60x60	Base	Long life	1	P-03947	0088381932820	77,00
250	Adaptador	★★★	1	P-16352	0088381932387	28,00

Adaptador para picas de toma de tierra

- Para clavar las picas en tierra.



502024

Ø (mm)	Largo (mm)	Serie	Unds.	Código	EAN	P.V.P. (€)
13	260	Long life ★★★	1	502024	-	36,00
16	260		1	P-63797	0088381994316	41,00
19	260		1	502026	-	46,00
22,2	260		1	E-13041	0088381590211	57,00

Estuches SDS-MAX



Contenido	Serie	Unds.	Código	EAN	P.V.P. (€)
Punteros	Standard ★★	2	D-40565	0088381403405	62,00
Cinceles		2			
Espátulas		2			



Contenido	Serie	Unds.	Código	EAN	P.V.P. (€)
Puntero	Standard ★★	1	D-42450	0088381404914	46,00
Cinzel		1			
Espátula		1			

Makita Hexagonal 17mm

- Para modelos **HM0810T** y **HM0830T**

Punteros



- Para todo tipo de obras en mampostería, hormigón y piedra suelta.



D-08682

Ancho (mm)	Largo (mm)	Serie	Unds.	Código	EAN	P.V.P. (€)
17	280	Standard ★★	1	D-08682	0088381182911	3,35
17	450		1	D-16863	0088381192897	9,30
17	450	Long life ★★★	1	P-13041	0088381932844	21,00

Espátulas



- Para la demolición en material de mayor volumen.



P-13079

Ancho (mm)	Largo (mm)	Serie	Unds.	Código	EAN	P.V.P. (€)
50	280	Standard ★★	1	D-20694	0088381277709	5,20
45	280	Long life ★★★	1	P-13079	0088381932875	20,15

Escoplo acanalado con aletas



- Para acanalar en piedra caliza, hormigón, ladrillos, piedra pómez, especialmente efectivo y seguro debido a su profundidad de acanalado variable de 10-35 mm. sin resbalar hacia el interior del surco.



P-13100

Ancho (mm)	Largo (mm)	Serie	Unds.	Código	EAN	P.V.P. (€)
35	380	Long life ★★★	1	P-13100	0088381932905	37,00

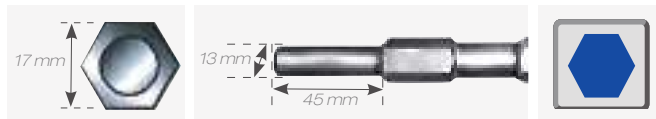

Cinceles



- Para todo tipo de obras de mampostería, hormigón y piedra suelta.



D-08707

Ancho (mm)	Largo (mm)	Serie	Unds.	Código	EAN	P.V.P. (€)
19	280	Standard ★★	1	D-08707	0088381182935	5,55
19	450		1	D-16879	0088381192880	6,10
24	280	Long life ★★★	1	P-13057	0088381932851	14,95
24	450		1	P-13063	0088381932868	17,40

Escoplo curvo



- Para acanalar en mampostería.



P-67393

Ancho (mm)	Largo (mm)	Serie	Unds.	Código	EAN	P.V.P. (€)
26	280	Long life ★★★	1	P-67393	0088381997928	31,00



B Hexagonal 19mm

- Para modelos **HR3520B, HR3850B, HR5000 y *HM1200B.**

Punteros



- Para todo tipo de obras en mampostería, hormigón y piedra suelta.



D-20074

Ancho (mm)	Largo (mm)	Serie	Unds.	Código	EAN	P.V.P. (€)
19	300	Standard	1	D-20074	0088381256087	8,40
19	450	★★	1	D-19196	0088381253918	9,50
19	300	Long life	1	P-13122	0088381932912	15,30
19	450	★★★	1	P-13138	0088381932929	19,65

- Para modelo **HM1200B**



Ø (mm)	Largo (mm)	Serie	Unds.	Código	EAN	P.V.P. (€)
19	400	Long life	1	P-05620	0088381921411	15,45
19	600	★★★	1	P-05614	0088381921404	20,10

Cinceles



- Para todo tipo de obras de mampostería, hormigón y piedra suelta.



P-13144

Ancho (mm)	Largo (mm)	Serie	Unds.	Código	EAN	P.V.P. (€)
24	300	Long life	1	P-13144	0088381932936	15,65
24	450	★★★	1	P-13150	0088381932943	18,50

- Para modelo **HM1200B.**



Ancho (mm)	Largo (mm)	Serie	Unds.	Código	EAN	P.V.P. (€)
25	400	Long life	1	P-05636	0088381921428	14,60
25	600	★★★	1	P-05642	0088381921435	19,60

Pala



- Para modelo **HM1200B.**



P-05670

Ancho (mm)	Largo (mm)	Serie	Unds.	Código	EAN	P.V.P. (€)
105	400	Long life	1	P-05670	0088381921466	63,00

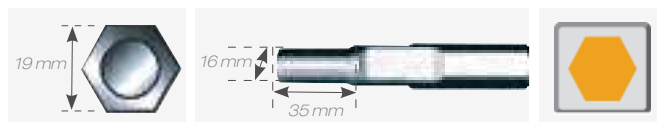

Escoplo curvo



- Para acanalar en mampostería.



P-13188

Ancho (mm)	Largo (mm)	Serie	Unds.	Código	EAN	P.V.P. (€)
22	250	Long life	1	P-13188	0088381932974	23,00

- Para modelo **HM1200B**



Ancho (mm)	Largo (mm)	Serie	Unds.	Código	EAN	P.V.P. (€)
22	300	Long life	1	P-05658	0088381921442	23,00

Escoplo acanalado con aletas



- Para acanalar en piedra caliza, hormigón, ladrillos, piedra pómez, especialmente efectivo y seguro debido a su profundidad de acanalado variable de 10-35 mm. sin resbalar hacia el interior del surco.



P-13219

Ancho (mm)	Largo (mm)	Serie	Unds.	Código	EAN	P.V.P. (€)
35	380	Long life	1	P-13219	0088381932998	54,00

Espátulas



- Para la demolición en material de mayor volumen.



P-13166

Ancho (mm)	Largo (mm)	Serie	Unds.	Código	EAN	P.V.P. (€)
50	300	Long life	1	P-13166	0088381932950	27,00

- Para modelo **HM1200B.**



Ancho (mm)	Largo (mm)	Serie	Unds.	Código	EAN	P.V.P. (€)
60	300	Long life	1	P-05664	0088381921459	29,00
60	450	★★★	1	P-05686	0088381921473	37,00

Makita Hexagonal 21mm

- Para modelo **HM1200**.

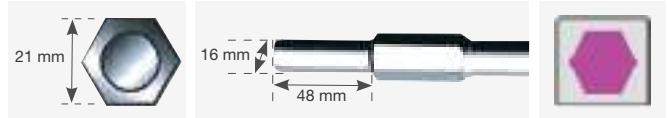

Punteros



- Para todo tipo de obras en mampostería, hormigón y piedra suelta.



P-13378

Ancho (mm)	Largo (mm)	Serie	Unds.	Código	EAN	P.V.P. (€)
21	450	Standard ★★	1	D-23824	0088381312912	9,00
21	320	Long life ★★★	1	P-13378	0088381112468	17,80
21	450		1	P-13384	0088381943116	23,00
21	600		1	P-13390	0088381104432	24,00

Cinceles



- Para todo tipo de obras de mampostería, hormigón y piedra suelta.



P-13409

Ancho (mm)	Largo (mm)	Serie	Unds.	Código	EAN	P.V.P. (€)
24	320	Long life	1	P-13409	0088381943147	18,60
24	450	★★★	1	P-13415	0088381943154	24,00

Espátulas



- Para la demolición en material de mayor volumen.



P-13437

Ancho (mm)	Largo (mm)	Serie	Unds.	Código	EAN	P.V.P. (€)
70	320	Long life ★★★	1	P-13437	0088381943178	39,00

Pala



798035-0

Ancho (mm)	Largo (mm)	Serie	Unds.	Código	EAN	P.V.P. (€)
120	450	Long life ★★★	1	798035-0	0088381103558	92,00



Makita Hexagonal 30mm

- Para modelos **HM1317C, HM1307C y *HM1400.**

Punteros

- Para todo tipo de obras en mampostería, hormigón y piedra suelta.



D-15285

Ancho (mm)	Largo (mm)	Serie	Unds.	Código	EAN	P.V.P. (€)
30	410	Standard ★★	1	D-15285	0088381186377	16,55
30	400	Long life ★★★	1	P-05549	0088381921336	31,00
30	400		1	B-10388*	0088381342483	35,00
30	700		1	P-05561	0088381921350	45,00

*autoafilable

Espátulas

- Para la demolición en material de mayor volumen.



D-23868

Ancho (mm)	Largo (mm)	Serie	Unds.	Código	EAN	P.V.P. (€)
75	310	Standard ★★	1	D-23868	0088381313094	21,75
75	310		1	D-34805	0088381365802	21,75
115	400	Long life ★★★	1	P-13518	0088381943239	73,00

- Para modelo **HM1400.**

Ancho (mm)	Largo (mm)	Serie	Unds.	Código	EAN	P.V.P. (€)
110	400	Long life ★★★	1	P-13493	0088381943215	61,00

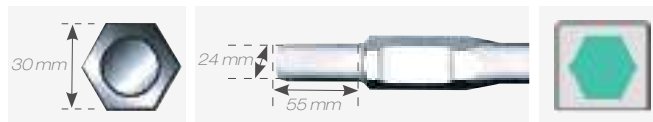

Cinceles

- Para todo tipo de obras de mampostería, hormigón y piedra suelta.



D-15300

Ancho (mm)	Largo (mm)	Serie	Unds.	Código	EAN	P.V.P. (€)
30	400	Standard ★★	1	D-15300	0088381186384	17,15
32	410	Long life ★★★	1	P-13487	0088381943208	30,00

- Para modelo **HM1400**

Ancho (mm)	Largo (mm)	Serie	Unds.	Código	EAN	P.V.P. (€)
32	400	Long life ★★★	1	P-13502	0088381943222	31,00
32	700		1	P-05583	0088381921374	44,00

Pisón



A-31485

Ø (mm)	Serie	Unds.	Código	EAN	P.V.P. (€)
200	Long life ★★★	1	A-31485	0088381151610	115,00

Pala



A-31485

Ancho (mm)	Largo (mm)	Tipo	Unds.	Código	EAN	P.V.P. (€)
125	400	Long life ★★★	1	P-05555	0088381921343	76,00
120	500	Standar ★★	1	B-10300	0088381341288	99,00

- Para modelo **HM1400**

Ancho (mm)	Largo (mm)	Serie	Unds.	Código	EAN	P.V.P. (€)
125	400	Long life ★★★	1	P-05608	0088381921398	58,00

Makita Hexagonal 28,6mm

- Para modelos **HM1317CB**, **HM1304B**, **HM1801**, **HM1810** y **HM1812**.



Punteros



- Para todo tipo de obras en mampostería, hormigón y piedra suelta.



P-05692

Ancho (mm)	Largo (mm)	Serie	Unds.	Código	EAN	P.V.P. (€)
28,6	400	Long life	1	P-05692	0088381921480	28,00
28,6	600	★★★	1	P-64272	0088381994798	47,00
28,6	400	Premium ★★★★★	1	B-10372*	0088381342476	32,00

*autoafilable



D-17631

Ancho (mm)	Largo (mm)	Serie	Unds.	Código	EAN	P.V.P. (€)
28,6	400	Long life	1	D-17631	0088381197182	18,90
28,6	600	★★★	1	P-65931	0088381996464	36,00

Cinceles



- Para todo tipo de obras de mampostería, hormigón y piedra suelta.

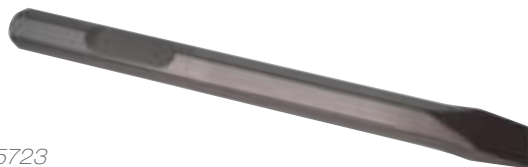

P-05723

Ancho (mm)	Largo (mm)	Serie	Unds.	Código	EAN	P.V.P. (€)
35	400	Long life	1	P-05723	0088381921510	27,00
30	600	★★★	1	P-64288	0088381994804	47,00



P-65947

Ancho (mm)	Largo (mm)	Serie	Unds.	Código	EAN	P.V.P. (€)
28	410	Standard ★★	1	D-17647	0088381197199	18,90
30	600	Long life ★★★★★	1	P-65947	0088381996471	36,00

Espátulas



- Para la demolición en material de mayor volumen.



D-29228

Ancho (mm)	Largo (mm)	Serie	Unds.	Código	EAN	P.V.P. (€)
75	410	Standard ★★	1	D-29228	0088381345682	20,05
80	400	Long life ★★★★★	1	P-05701	0088381921497	49,00

Pisón



798385-3

Ø (mm)	Serie	Unds.	Código	EAN	P.V.P. (€)
200	Long life ★★★★★	1	798385-3	0088381127554	203,00

Pala



P-05717

Ancho (mm)	Largo (mm)	Serie	Unds.	Código	EAN	P.V.P. (€)
125	400	Long life ★★★★★	1	P-05717	0088381921503	70,00



K Hexagonal 21mm

- Para modelos K.



Punteros



- Para todo tipo de obras en mampostería, hormigón y piedra suelta.

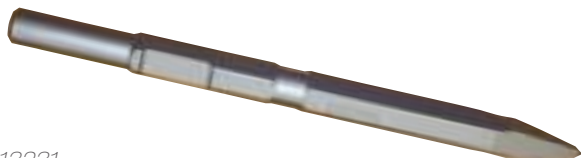

P-13231

Ancho (mm)	Largo (mm)	Serie	Unds.	Código	EAN	P.V.P. (€)
21	300	Long life ★★★	1	P-13231	0088381933001	18,05
21	460		1	P-13253	0088381943024	23,00
21	600		1	P-13269	0088381943031	25,00

Espátulas



- Para la demolición en material de mayor volumen.



P-13312

Ancho (mm)	Largo (mm)	Serie	Unds.	Código	EAN	P.V.P. (€)
75	300	Long life ★★★	1	P-13312	0088381943086	31,00

Pala



A-07157

Ancho (mm)	Largo (mm)	Serie	Unds.	Código	EAN	P.V.P. (€)
120	500	Long life ★★★	1	A-07157	0088381111980	93,00

Cinceles



- Para todo tipo de obras de mampostería, hormigón y piedra suelta.



P-13275

Ancho (mm)	Largo (mm)	Serie	Unds.	Código	EAN	P.V.P. (€)
25	300	Long life ★★★	1	P-13275	0088381126717	18,05
25	460		1	P-13297	0088381943062	21,00
25	600		1	P-13306	0088381943079	27,00

Escoplo acanalado con aletas



- Para acanalar en piedra caliza, hormigón, ladrillos, piedra pómez, especialmente efectivo y seguro debido a su profundidad de acanalado variable de 10-35 mm. sin resbalar hacia el interior del surco.

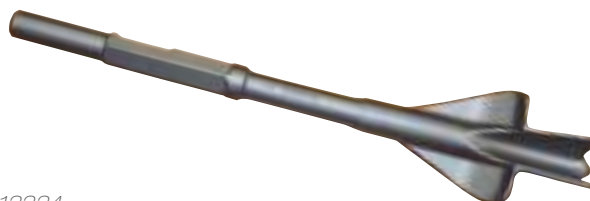

P-13334

Ancho (mm)	Largo (mm)	Serie	Unds.	Código	EAN	P.V.P. (€)
35	380	Long life ★★★	1	P-13334	0088381943109	54,00



Makita Hexagonal 19mm

- Para modelo HK1810

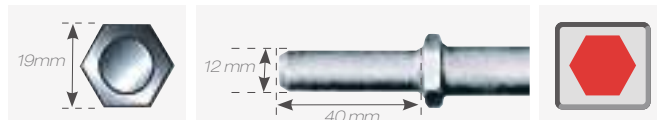

Puntero



- Para todo tipo de obras en mampostería, hormigón y piedra suelta.



Ancho (mm)	Largo (mm)	Serie	Unds.	Código	EAN	P.V.P. (€)
19	220	Long life ★★★	1	B-06921	0088381313292	13,40

Cinzel



- Para todo tipo de obras de mampostería, hormigón y piedra suelta.



Ancho (mm)	Largo (mm)	Serie	Unds.	Código	EAN	P.V.P. (€)
20	220	Long life ★★★	1	B-07004	0088381313308	16,75

Cinceles curvos



- Retirada de azulejos de forma fácil y sencilla (con extremo acodado de forma ergonómica).



Ancho (mm)	Largo (mm)	Serie	Unds.	Código	EAN	P.V.P. (€)
35	190	Long life ★★★	1	P-05496	0088381921282	24,00
50	190		1	P-05474	0088381921268	25,00

Espátula



- Para la demolición en material de mayor volumen.



Ancho (mm)	Largo (mm)	Serie	Unds.	Código	EAN	P.V.P. (€)
50	220	Long life ★★★	1	B-07010	0088381313315	19,05

Rascador



Ancho (mm)	Tipo	Unds.	Código	EAN	P.V.P. (€)
100	Rascador completo	1	122431-4	0088381114882	64,00
100	Solo Cuchilla	1	343411-9	0088381118415	29,00

Escoplo



Ancho (mm)	Serie	Unds.	Código	EAN	P.V.P. (€)
45	Long life ★★★	1	P-05480	0088381921275	28,00



Set eje - mandril SDS-MAX



Descripción	Rosca	Inserción	Unds.	Código	EAN	P.V.P. (€)
Set	1/2"	SDS-MAX	1	122829-5	0088381435901	61,00

Portabrocas y portaherramientas para martillos ligeros



Portabrocas automático



Portaherramientas SDS-PLUS



Descripción	mm	Modelos	Unds.	Código	EAN	P.V.P. (€)
Portabrocas	13	DHR243 DHR263 HR002G HR2630T HR2631FT HR2810T HR2811FT	1	194079-2	0088381196826	60,00
	13	DHR281 DHR283	1	199139-5	0088381525695	51,00
	13	HR3210FCT	1	194568-7	0088381347389	69,00
	13	HR3012	1	191F46-4	0088381560795	51,00
Portaherramientas SDS-PLUS	-	DHR243 DHR263 HR2630T HR2631FT HR2810T HR2811FT	1	194080-7	0088381196833	31,00
	-	DHR281 DHR283	1	199138-7	0088381525718	22,00
	-	HR3210FCT	1	125420-8	3240890170774	55,00
	-	HR3012	1	191F47-2	0088381560801	32,00

Carro de transporte



Modelos	Unds.	Código	EAN	P.V.P. (€)
HM1812	1	D-54972	0088381450904	138,00

Set eje - mandril SDS-PLUS



P-18150



D-14093

con portabrocas

Descripción	Rosca	Inserción	Unds.	Código	EAN	P.V.P. (€)
Set	1/2"	SDS-PLUS	1	P-18150	0088381944472	44,00
Adaptador	1/2"	SDS-PLUS	1	D-14093	0088381359450	2,60

Perilla de soplado



Unds.	Código	EAN	P.V.P. (€)
1	765009-6	0088381102377	2,30

Aceite grafitado



Contenido (gr)	Unds.	Código	EAN	P.V.P. (€)
30	1	P-08361	0088381913072	3,10

Paño para limpieza



Unds.	Código	EAN	P.V.P. (€)
1	443122-7	0088381205658	3,05

Grasa para broca



198993-4



183477-5

Contenido (gr)	Unds.	Código	EAN	P.V.P. (€)
30	1	183477-5	0088381373760	3,85
100	1	198993-4	0088381518994	6,20

Sistemas de protección frente al polvo

Cada día Makita cuida la salud y la comodidad en el trabajo de nuestros usuarios, y uno de los mayores peligros es la inhalación de polvo mineral.



A la larga puede causar graves problemas respiratorios por lo que resulta imprescindible actuar sobre este problema.

Para eso, Makita ha desarrollado una completa gama de accesorios de aspiración para la conexión con gran parte de nuestros martillos ligeros.

El polvo no es algo que puedas esconder debajo de la alfombra, es algo peligroso que puede afectar a tu salud. **¡Actúa!**



Colectores de polvo auto aspirantes



Tipo	Modelos	Medidas (mm)	Unds.	Código	EAN	P.V.P. (€)
DX01	DHR242	372 x 88 x 287	1	195898-9	0088381400589	114,00
DX02	DHR243	397 x 88 x 287	1	195902-4	0088381400626	114,00
DX05	DHR182	431 x 82 x 285	1	199664-6	0088381540315	91,00
DX08	DHR280 DHR282	435 x 86 x 306	1	199581-0	0088381540827	145,00
DX09	DHR281 DHR283	457 x 86 x 306	1	199585-2	0088381540865	145,00
DX10	HR3011FC	592 x 145 x 242	1	191F95-1	0088381565752	113,00
DX11	HR3012FC	661 x 145 x 242	1	191G00-4	0088381565806	113,00
DX12	HR001G HR003G	425 x 86 x 306	1	191E54-9	0088381560047	160,00



Filtro para DX01, DX02, DX03, DX05, DX08, DX09 y DX12



Válido	Descripción	Unds.	Código	EAN	P.V.P. (€)
DX01 DX02 DX08 DX09 DX12	Filtro HEPA	1	199557-7	0088381539784	11,00
DX03	Set alojamiento de filtro	1	196162-1	0088381413220	30,00
DX05	Filtro HEPA	1	199596-7	0088381541466	8,75
DX10 DX11	Set caja colector de polvo	1	191F49-8	0088381560818	49,00



Colectores de polvo para martillos ligeros



Modelos	Unds.	Código	EAN	P.V.P. (€)
HR2651T	1	136017-8	0088381585910	89,00
HR2650	1	136018-6	0088381548502	95,00



Extractor de polvo



Modelos	Unds.	Código	EAN	P.V.P. (€)
HR2230 HR2460 HR2470	1	193472-7	0088381174022	46,00

Recolector de polvo SDS-PLUS



Modelos	Unds.	Código	EAN	P.V.P. (€)
DHR171 DHR182 DHR202 DHR263 HR140D HR166D HR1830 HR1841F HR2230 HR2470 HR2800 HR2810 HR2811	1	198362-9*	0088381483636	15,60

* Utilizar con adaptador.

Adaptadores para utilizar con recolector de polvo. 198362-9

Modelos	Unds.	Código	EAN	P.V.P. (€)
DHR165 DHR171 DHR182 HR1830 HR140D HR166D HR1841F	1	194581-5	0088381371599	13,40
DHR202 DHR263 HR2810T HR2811FT	1	194582-3	0088381367219	5,10
HR2230 HR2460 HR2470	1	194583-1	0088381367226	4,80
HR3011 HR3012	1	191L91-5	0088381567411	5,60

Bolsa de polvo



Modelos	Unds.	Código	EAN	P.V.P. (€)
HR2430	1	193976-9	0088381191333	13,40
HR2432	1	122708-7	0088381202992	8,45

Tapas para polvo



Tipo 1

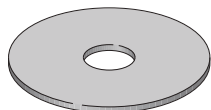

Indicado para	Tipo	Unds.	Código	EAN	P.V.P. (€)
Brocas 6 a 14 mm. Ø	1	1	421342-3	008838116602	2,30
Brocas 12 a 16 mm. Ø	1	1	421664-1	0088381149754	3,60
HK1810	2	1	423154-0	0088381123846	0,75

Colector de polvo SDS-PLUS



Podemos conectar dos colectores para aspirar cuando trabajemos con brocas más largas.

Modelos	Unds.	Código	EAN	P.V.P. (€)
DHR242 DHR280 DHR282 HR2630 HR2600 HR2300	1	195173-3	0088381361125	7,05
DHR243 DHR281 DHR283 HR2611FT HR2630T	1	195179-1	0088381361194	8,40

Adaptador 1/2" a SDS-MAX

(para sacar brocas que se han quedado bloqueadas)



* Utilizar con llaves de impacto de 1/2".

Tipo	Unds.	Código	EAN	P.V.P. (€)
1/2"	1	195870-1	0088381398336	103,00

Colectores de polvo para martillos combinados



Kit

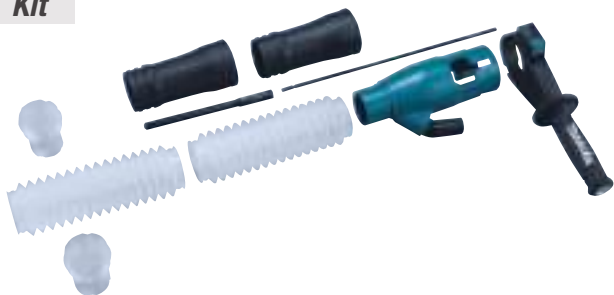

Modelos	Unds.	Código	EAN	P.V.P. (€)
HR4001C HR4011C HR4501C HR4511C	1	196074-8	0088381407632	105,00
HR5212C	1	196858-4	0088381441599	77,00
DHR400 HR4003C HR4013C	1	199142-6	0088381524339	100,00

Makita

Colectores de polvo para martillos demoledores



Modelos	Unds.	Código	EAN	P.V.P. (€)
HM1307C HM1317C HM1400 HM1812	1	197168-2	0088381449984	53,00
HM1501	1	191M20-4	0088381575713	63,00

Empuñaduras

Tipo 1



* Solo puño.

Modelos	Unds.	Código	EAN	P.V.P. (€)
HR2800 HR2230 HR2460 HR2470 HR2810 HR2811	1	158057-6	3240890278531	4,55
HR2510	1	273496-0	3240890119971	11,35
HR3000C HM0860C HM0830T	1	152554-4	0088381156318	8,50
HR3520B HR3850B HR5000K	1	273472-4	0088381115841	10,30
HR4000C HR4001C HR4011C	1	134803-1	0088381144384	28,00
HR4501C HR4511C HR5201C HR5211C	1	158131-0	0088381346115	10,30
HM0810T HR3850B HR3520B	1	273457-0	0088381123440	10,80

Tipo 2



Modelos	Unds.	Código	EAN	P.V.P. (€)
HR3520B HR3850B HR5000 HR5000K	1	134887-9	0088381151474	37,00
HR4000C HR4001C HR4011C HR4501C HR4511C HM1111C HM1101C HR3540C HR3541FC	1	134890-0	0088381152266	34,00
HR4500C	1	134915-0	0088381160087	28,00
HR5001C	1	134945-1	0088381164979	28,00
HR5201C HR5211C HM1202C HM1203C HM1213C	1	135269-8	0088381359528	39,00
HM1200K	1	134944-3	0088381200998	22,00
HM0860C HM0830T HM0870C HM0871C HM1100C HM1200 HM1200B	1	134909-5	0088381164962	26,00
HM1214C HR5202C HR5212C	1	135283-4	0088381359771	38,00
HR4003C	1	196792-8	0088381568678	25,00

Tipo 3



* Empuñadura completa

Modelos	Unds.	Código	EAN	P.V.P. (€)
HR2020 HR2440 HR2450 HR2432	1	135302-6	0088381364430	3,70
HR2300 HR2600 HR2610 HR2610T HR2611FT	1	122878-2	0088381401463	13,10
HR3000C	1	134889-5	0088381152297	20,10
HR3200C HR3210C/FCT	1	135197-7	0088381349710	20,10
HR3540C HR3541FC HR4001C HR4011C HR4501C HR4511C	1	135209-6	0088381361828	21,00
HR4500C	1	134916-8	0088381160094	23,00
HR5001C	1	134881-1	0088381152921	26,00
HR5201C HR5211C	1	135380-6	0088381366243	23,00
HM001G HM0870C HM0871C	1	135332-7	0088381367196	22,00

Tipo 1



Tipo 2



Tipo 3



Taladrar

- Metal
- Madera
- Mampostería
- Cristal

Avellanar

Batir



Ezychange



Brocas de corona Unicut para mampostería y azulejo

Broca de corona



UNICut

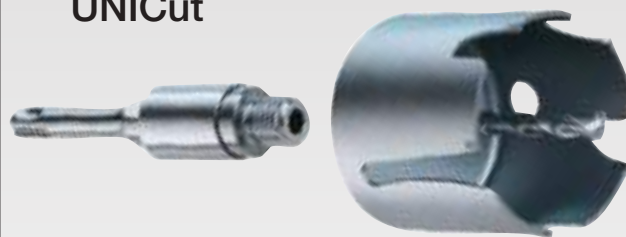

Las brocas UNICut son diseñadas para el empleo en una amplia gama de materiales:

- Albañilería con mampostería, ladrillos, azulejos, etc.
- Materiales ligeros como tabla de yeso, tabi, Fermacell, etc.
- En plástico, madera prensada, contrachapado, etc.

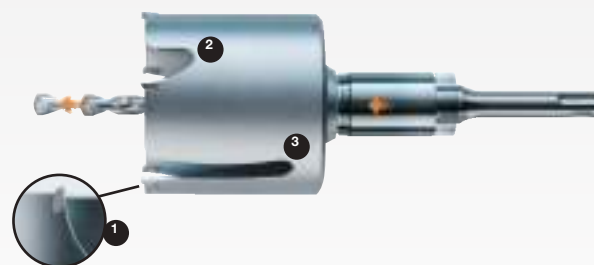

UNICut ¡ventajas convincentes!:

- 1** Robusta y duradera: Los dientes de carburo, con una superficie más amplia, soldados (1) de forma semejante al de una caja fuerte, aseguran y garantizan que los dientes no se desprenderán de la broca.
- 2** Rápida progresión taladrando: debido a la robusta estructura y corte agresivos.
- 3** Optimizando la vida del cuerpo: La vibración ha sido mejorada debido a la geometría especial de las cámaras de desalajo ampliadas (2) y la ranura de extracción de gases (3).

Ø (mm)	Largo (mm)	Modelos	Unds.	Código	EAN	P.V.P. (€)
25	60	HR2300 HR2600 HR2610 HR2610T HR2611FT HR2630 HR2630T HR2631	1	P-64462	0088381994989	29,00
30	60		1	P-64478	0088381994996	29,00
35	60		1	P-64484	0088381995009	33,00
40	60		1	P-64490	0088381995016	34,00
45	60		1	P-64509	0088381995023	35,00
50	60		1	P-64515	0088381995030	36,00
55	60		1	P-64521	0088381995047	38,00
58	60		1	P-64537	0088381995054	42,00
60	60		1	P-64543	0088381995061	42,00
63	60		1	P-64559	0088381995078	42,00
65	60		1	P-64565	0088381995085	43,00
68	60		1	P-64571	0088381995092	46,00
70	60		1	P-64587	0088381995108	52,00
71	60		1	P-64593	0088381995115	53,00
74	60	HR2800 HR2810 HR2810T HR2811FT HR3011 HR3012 HR3200C HR3210C HR3210FCT	1	P-64602	0088381995122	54,00
76	60		1	P-64618	0088381995139	55,00
80	60		1	P-64630	0088381995153	57,00
85	60		1	P-64646	0088381995160	62,00
90	60		1	P-64652	0088381995177	64,00
105	60		1	P-64668	0088381995184	83,00

Adaptador para brocas UNICut



Ø (mm)	Largo (mm)	Unds.	Código	EAN	P.V.P. (€)
M16	118	1	P-64319	0088381994835	28,00
M16	370	1	P-64331	0088381994859	34,00

Broca de centrado para brocas Unicut



Ø (mm)	Largo (mm)	Punta	Unds.	Código	EAN	P.V.P. (€)
8	120	TCT	1	P-64347	0088381994866	6,25



Brocas para ladrillo ★★



Ø (mm)	Largo (mm)	Unds.	Código	EAN	P.V.P. (€)
3	60	1	D-05228	0088381176453	1,15
4	70	1	D-05234	0088381176460	1,15
5	85	1	D-05240	0088381176477	1,15
6	100	1	D-05256	0088381176484	1,15
6	150	1	D-05262	0088381176491	1,15
7	100	1	D-05278	0088381176507	1,15
7	150	1	D-05284	0088381176514	1,15
8	110	1	D-05290	0088381176521	1,15
8	150	1	D-05309	0088381176538	1,15
9	150	1	D-05315	0088381176545	1,15
10	150	1	D-05321	0088381176552	1,45
11	150	1	D-05337	0088381176569	1,45
12	150	1	D-05343	0088381176576	2,00
13	150	1	D-05359	0088381176583	2,60
14	150	1	D-05365	0088381176590	2,60
15	150	1	D-05371	0088381176606	2,60
16	150	1	D-05387	0088381176613	2,90

Brocas para ladrillo TCT ★★★



Ø (mm)	Largo (mm)	Unds.	Código	EAN	P.V.P. (€)
3	60	1	E-06351	0088381569309	1,40
4	70	1	E-06367	0088381569316	1,40
5	85	1	E-06373	0088381569323	1,40
5	150	1	E-06389	0088381569330	1,40
6	100	1	E-06410	0088381569361	1,40
6	150	1	E-06426	0088381569378	1,40
8	110	1	E-06482	0088381569439	1,40
8	150	1	E-06498	0088381569446	1,40
10	150	1	E-06529	0088381569477	1,40
10	250	1	E-06535	0088381569484	2,85
12	150	1	E-06541	0088381569491	2,25
12	250	1	E-06557	0088381569507	3,10
14	150	1	E-06563	0088381569514	2,85
14	250	1	E-06579	0088381569521	3,95
16	150	1	E-06585	0088381569538	3,15
18	200	1	E-06591	0088381569545	4,55
20	200	1	E-06600	0088381569552	5,10

Brocas para ladrillo 1/4" hexagonal ★★



Ø (mm)	Largo (mm)	Unds.	Código	EAN	P.V.P. (€)
5	90	1	D-23793	0088381312882	1,95
6	100	1	D-23802	0088381312899	2,00
8	100	1	D-23818	0088381312905	2,70

Brocas punta de flecha 1/4" hexagonal ★★★



Ø (mm)	Largo (mm)	Unds.	Código	EAN	P.V.P. (€)
4	65	1	D-15942	0088381187107	2,60
5	65	1	D-15958	0088381187114	2,60
6	65	1	D-15964	0088381187121	2,85
8	70	1	D-15970	0088381187138	2,85
10	80	1	D-15986	0088381187145	3,50



Brocas multimaterial

Omn|Bohrer

★★



Ø (mm)	Largo (mm)	Largo útil (mm)	Unds.	Código	EAN	P.V.P. (€)
3	60	26	1	D-30287	0088381353151	0,85
4	70	36	1	D-30293	0088381353168	0,85
5	85	41	1	D-30302	0088381353175	0,85
5,5	100	56	1	D-31033	0088381355056	0,85
6	150	101	1	D-30324	0088381353199	0,90
6	250	170	1	D-72780	0088381577298	1,70
6,5	100	56	1	D-31061	0088381355087	0,90
7	150	101	1	D-30346	0088381353212	1,15
8	150	95	1	D-30368	0088381353236	1,15
9	150	95	1	D-30374	0088381353243	1,40
10	150	95	1	D-30380	0088381353250	1,45
12	150	91	1	D-30411	0088381353281	2,00
12	400	298	1	D-30427	0088381353298	4,30
13	150	83	1	D-30449	0088381353342	2,30
14	150	83	1	D-30455	0088381353311	2,60
14	400	298	1	D-30461	0088381353328	5,75

Brocas multimaterial

Omn|Bohrer

★★★



Ø (mm)	Largo (mm)	Largo útil (mm)	Unds.	Código	EAN	P.V.P. (€)
3	70	38	1	E-10958	0088381581615	1,50
4	75	40	1	E-10964	0088381581622	1,50
5	85	43	1	E-10970	-	1,60
5,5	100	50	1	E-10986	0088381581646	1,75
6	150	90	1	E-11003	0088381581660	2,05
6,5	150	90	1	E-11025	0088381581684	2,20
7	100	50	1	E-11031	0088381581691	2,05
8	150	90	1	E-11053	0088381581714	2,75
10	150	90	1	E-11069	0088381581721	3,25
12	150	90	1	E-11075	0088381581738	3,65
13	150	90	1	E-11081	0088381581745	4,50



Brocas estándar para madera

★★★

- Con punta centradora.



Ø (mm)	Largo (mm)	Largo útil (mm)	Unds.	Código	EAN	P.V.P. (€)
3	60	33	1	D-07026	0088381178587	0,90
4	75	43	1	D-07032	0088381178594	0,90
5	85	52	1	D-07048	0088381178600	0,90
6	95	57	1	D-07054	0088381178617	0,85
6	315	160	1	D-07157	0088381178716	3,05
7	110	69	1	D-07060	0088381178624	1,15
8	115	75	1	D-07076	0088381178631	1,15
8	315	160	1	D-07163	0088381178723	3,40
9	125	81	1	D-07082	0088381178648	1,45
10	135	87	1	D-07098	0088381178655	1,45
10	315	160	1	D-07179	0088381178730	4,10
12	155	101	1	D-07107	0088381178662	2,05
12	315	160	1	D-07185	0088381178747	4,95
13	151	96	1	D-53453	0088381449373	2,65
14	170	108	1	D-07113	0088381178679	2,60
14	315	160	1	D-07191	0088381178754	5,85
15	160	100	1	D-53469	0088381449380	3,25
16	180	105	1	D-07129	0088381178686	4,10
16	315	160	1	D-07200	0088381178761	7,00
18	200	120	1	D-07135	0088381178693	5,85
18	335	160	1	D-07216	0088381178778	9,40
20	200	130	1	D-07141	0088381178709	6,45
20	335	160	1	D-07222	0088381178785	11,75

Brocas helicoidales para madera

★★★

- Ideal para taladros pasantes.
- Gran extracción de viruta.
- Punta autorroscante.



Ø (mm)	Largo (mm)	Largo útil (mm)	Unds.	Código	EAN	P.V.P. (€)
6	250	180	1	D-07331	0088381178891	3,25
8	250	180	1	D-07347	0088381178907	3,40
8	450	380	1	D-07559	0088381179119	7,10
10	250	180	1	D-07353	0088381178914	5,20
10	450	380	1	D-07565	0088381179126	7,65
12	250	180	1	D-07369	0088381178921	5,70
12	450	380	1	D-07571	0088381179133	8,75
13	250	180	1	D-53475	0088381449397	6,00
13	450	380	1	D-53497	0088381449410	9,55
14	250	180	1	D-07375	0088381178938	6,55
14	450	380	1	D-07587	0088381179140	9,55
15	250	180	1	D-53481	0088381449403	6,55
15	450	380	1	D-53506	0088381449427	10,65
16	250	180	1	D-07381	0088381178945	6,80
16	450	380	1	D-07593	0088381179157	11,15
18	250	180	1	D-07397	0088381178952	7,65
18	450	380	1	D-07602	0088381179164	12,50
20	250	180	1	D-07406	0088381178969	7,90
20	450	380	1	D-07618	0088381179171	14,30
22	250	180	1	D-07412	0088381178976	8,45
22	450	380	1	D-07624	0088381179188	15,80
24	250	180	1	D-07428	0088381178983	9,00
24	450	380	1	D-07630	0088381179195	17,70
26	450	380	1	D-07646	0088381179201	20,15
28	450	380	1	D-07652	0088381179218	23,00
30	450	380	1	D-07668	0088381179225	27,00

Brocas estándar para madera 1/4" hexagonal

★★★



Ø (mm)	Largo (mm)	Largo útil (mm)	Unds.	Código	EAN	P.V.P. (€)
3	75	33	1	D-15861	0088381187022	1,15
4	90	43	1	D-15877	0088381187039	1,15
5	100	52	1	D-15883	0088381187046	1,45
6	110	57	1	D-15899	0088381187053	1,45
8	115	75	1	D-15908	0088381187060	2,05
10	130	87	1	D-15914	0088381187077	2,35
12	150	101	1	D-15920	0088381187084	3,20
15	160	108	1	D-15936	0088381187091	5,00

Brocas helicoidales para madera 1/4" hexagonal

★★★



Ø (mm)	Largo (mm)	Largo útil (mm)	Unds.	Código	EAN	P.V.P. (€)
6	200	130	1	D-15992	0088381187152	4,05
8	200	130	1	D-16003	0088381187169	4,60
10	200	130	1	D-16019	0088381187176	5,45
12	200	130	1	D-16025	0088381187183	5,75
14	200	130	1	D-16031	0088381187190	5,70
16	200	130	1	D-16047	0088381187206	5,85
18	200	130	1	D-16053	0088381187213	6,55
20	200	130	1	D-16069	0088381187220	7,60
21	200	130	1	D-16075	0088381187237	9,50

Brocas de pala para madera ★★

- Con punta centradora.
- Gran velocidad de taladrado.



Ø (mm)	Largo (mm)	Unds.	Código	EAN	P.V.P. (€)
6	150	1	D-07674	0088381179232	1,45
8	150	1	D-07680	0088381179249	1,45
10	150	1	D-07696	0088381179256	1,45
12	150	1	D-07705	0088381179263	1,75
13	150	1	D-67614	0088381549363	1,75
14	150	1	D-07711	0088381179270	1,75
15	150	1	D-07727	0088381179287	1,75
16	150	1	D-07733	0088381179294	1,75
18	150	1	D-07749	0088381179300	2,05
20	150	1	D-07755	0088381179317	2,05
22	150	1	D-07761	0088381179324	2,05
24	150	1	D-07777	0088381179331	2,65
25	150	1	D-07783	0088381179348	2,65
26	150	1	D-07799	0088381179355	2,65
28	160	1	D-07808	0088381179362	2,90
30	160	1	D-07814	0088381179379	3,20
32	160	1	D-07820	0088381179386	3,55
34	160	1	D-07836	0088381179393	3,80
35	160	1	D-07842	0088381179409	3,80
36	160	1	D-07858	0088381179416	4,10



Brocas de precisión Forstner para madera ★★

- Perforaciones perfectas, con menos rebabas.
- Menos ruido.
- Menos esfuerzo.
- Presentado en bote de plástico con gancho para colgar.
- El diseño de los dientes ofrece una alta precisión y un gran rendimiento.
- Punta centradora que permite un preciso inicio de taladrado.
- Medida marcada en la broca para reconocerla fácilmente.
- Puede utilizarse en taladros con portabrocas de 10mm y 13mm.



Ø (mm)	Largo (mm)	Unds.	Código	EAN	P.V.P. (€)
10	90	1	D-41844	0088381404648	6,15
15	90	1	D-41925	0088381404686	7,25
20	90	1	D-42232	0088381404693	8,35
25	90	1	D-42248	0088381404709	8,95
26	90	1	D-42254	0088381404716	9,50
30	90	1	D-42260	0088381404723	10,00
32	90	1	D-42276	0088381404730	10,60
35	90	1	D-42282	0088381404747	11,15
40	90	1	D-42298	0088381404754	12,85
50	90	1	D-42307	0088381404761	17,55



Brocas autoalimentadas para madera

- Punta del tornillo roscado empuja la broca hacia la pieza de trabajo, proporcionando la autoalimentación rápida y fácil de usar.
- Para perforar agujeros de gran diámetro limpiamente.
- Tienen un tornillo de alimentación central.
- Rosca de barrena.
- Las espuelas de contorno definen con precisión el diámetro del orificio.

★★



D-74304

D-74407

Ø (mm)	Largo (mm)	Unds.	Código	EAN	P.V.P. (€)
25	127	1	D-74304	0088381587341	11,85
28	127	1	D-74310	0088381587358	13,90
32	127	1	D-74326	0088381587365	15,45
35	127	1	D-74332	0088381587372	16,50
38	127	1	D-74348	0088381587389	18,55
45	127	1	D-74354	0088381587396	22,00
51	127	1	D-74360	0088381587402	24,00
54	127	1	D-74376	0088381587419	27,00
57	127	1	D-74382	0088381587426	32,00
65	127	1	D-74398	0088381587433	36,00
76	127	1	D-74407	0088381587440	54,00
92	127	1	D-74413	0088381587457	63,00
117	127	1	D-74429	0088381587464	80,00

Puntas para brocas autoalimentadas

★★



Ø (mm)	Unds.	Código	EAN	P.V.P. (€)
25 - 65	1	D-74435	0088381587471	1,30
76 - 117	1	D-74441	0088381587488	1,30

Extensiones para brocas autoalimentadas

★★



Largo (mm)	Unds.	Código	EAN	P.V.P. (€)
140	1	D-74457	0088381587495	10,30
305	1	D-74463	0088381587501	12,35
457	1	D-74479	0088381587518	14,95



Brocas cilíndricas para metal

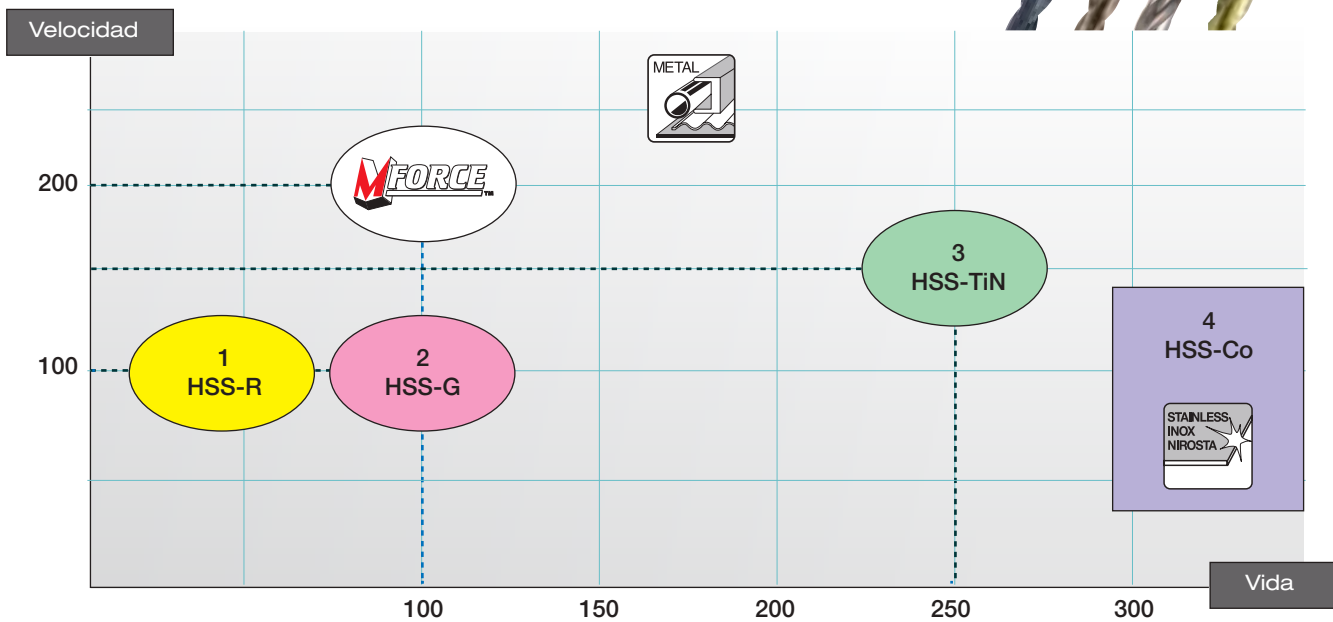
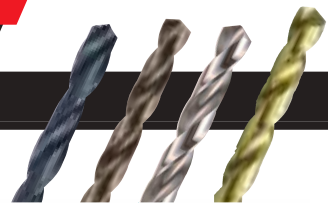

Descripción		A	B	C	D	E
		Material	Proceso de fabricación	Tipo de geometría	Acabado	Inserción
1	HSS-R	HSS	Laminada	118°	Negro	Cilíndrica
2	HSS-G	HSS	Rectificada	118°	Brillante	Cilíndrica
3	HSS-TiN	HSS	Rectificada	135°	Titanio	Cilíndrica o 1/4" hex.
4	HSS-Co	HSS-Co 5%	Rectificada	135°	Cobalto	Cilíndrica
5	M-FORCE	HSS - M-FORCE	Rectificada	M-FORCE	Titanio	Cilíndrica 3 Caras

Descripción		Material						
		Madera	Plástico	Metales no ferrosos	Chapa de acero	Hierro fundido	Acero	Acero inoxidable
1	HSS-R Broca de metal	◆	✓		◆	✓		
2	HSS-G Broca de metal	◆	✓	✓	✓	✓	✓	◆
3	HSS-TiN	◆	✓	✓	✓	✓	✓	◆
4	HSS-Co			◆	◆	✓	✓	✓
5	M-FORCE	◆	✓	✓	✓	✓	✓	◆

✓ : Recomendado ◆ : Válido



Brocas cilíndricas para metal

A Fabricado con...



Acero rápido



Acero rápido con un 5% de cobalto añadido.

Para una mayor resistencia a la abrasión y al calor. Ideal para taladrar metal duro.

B Tipo

HSS-R

Laminadas



Hecho con metal fundido a presión. Es el proceso más económico. Bisel en los bordes de la espiral para una mejor evacuación de la viruta.

HSS-G

Rectificadas



Tanto la espiral como el borde están fabricados del mismo bloque de metal, lo que proporciona a la broca una calidad superior. Biselado de la espiral para un corte más rápido y eficaz.

C Geometría de la punta

HSS-R y HSS-G

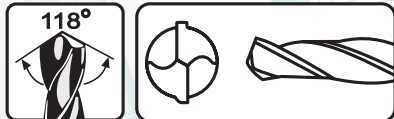

HSS-TIN y HSS-Co

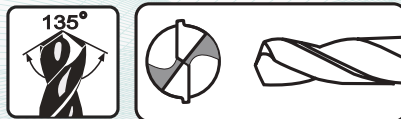

M-FORCE



El ángulo de 135° consigue que el inicio de la perforación sea más sencilla y evita que la broca patine.

Brocas con un punto de autocentrado en forma de M que evita su desplazamiento para una perforación más precisa.

D Acabado

Acabado negro

Acabado brillante

Acabado titanio

Acabado cobalto



Duran hasta un 150% más que otras brocas.

Alta calidad con un 5% de cobalto

E Inserción

Recto (cilíndrico)

Hexagonal 1/4"

Cilíndrico (3 caras)



Puede utilizarse con un portabrocas de 1/4". Permite que el cambio de brocas sea más sencillo.

Tres ejes planos en el vástago. Evita el deslizamiento de la broca

Brocas para metal HSS-R DIN338



- Brocas indicadas para el taladrado de acero con resistencia máxima de 900 N/mm², hierro fundido, plásticos y metales no ferrosos.
- Mínimo riesgo de rotura para diámetros pequeños gracias a la posibilidad de flexión del material.
- Espiral con dos salidas para una efectiva evacuación del material sobrante.
- Brocas para corte en metal con un ángulo en la punta de 118°.
- Bisel en los bordes de la espiral para una mejor evacuación de la viruta.

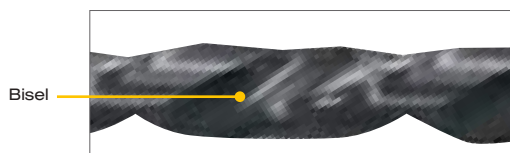

- Blíster con dos Unds. en las brocas con medidas comprendidas entre 1.5 – 4.0mm.
- Brocas de categoría estándar con muy buena relación calidad precio.

Ø (mm)	Largo (mm)	Largo útil (mm)	Unds.	Código	EAN	P.V.P. (€)
1,5	40	18	2	D-38299	0088381398787	1,15
2,0	49	24	2	D-38308	0088381398794	1,15
2,5	57	30	2	D-38314	0088381398800	1,10
3,0	61	33	2	D-38336	0088381398824	1,15
3,5	70	39	2	D-38358	0088381398848	1,15
4,0	75	43	2	D-38364	0088381398855	1,15
4,5	80	47	1	D-38386	0088381398879	0,85
5,0	86	52	1	D-38401	0088381398893	0,85
5,5	93	57	1	D-38417	0088381398909	0,85
6,0	93	57	1	D-38423	0088381398916	0,85
6,5	101	63	1	D-38439	0088381398923	1,15
7,0	109	69	1	D-38445	0088381398930	1,15
7,5	109	69	1	D-38451	0088381398947	1,15
8,0	117	75	1	D-38467	0088381398954	1,40
8,5	117	75	1	D-38473	0088381398961	1,40
9,0	125	81	1	D-38489	0088381398978	1,70
10,0	133	87	1	D-38495	0088381398985	2,00
11,0	142	94	1	D-38504	0088381398992	2,55
12,0	151	101	1	D-38510	0088381399005	3,10
13,0	151	101	1	D-38526	0088381399012	3,40

Brocas para metal HSS-G DIN338



- Brocas indicadas para el taladrado de acero con resistencia máxima de 900 N/mm², metales de fundición, plásticos duros y metales no ferrosos.
- Ofrece una perforación más rápida y una vida útil superior.
- Espiral con dos salidas para una efectiva evacuación del material sobrante.
- Excelente calidad del acero con la que está realizada esta broca.
- Brocas para corte en metal con un ángulo en la punta de 135°.
- Biselado de la espiral para una corte más rápido y eficaz.
- Brocas de buena calidad para aplicaciones profesionales.

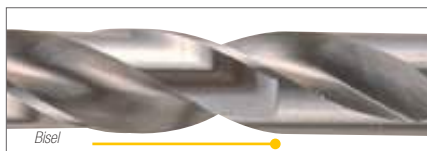

Ø (mm)	Largo (mm)	Largo útil (mm)	Unds.	Código	EAN	P.V.P. (€)
1,5	40	18	1	D-09656	0088381184922	0,85
2,0	49	24	1	D-09662	0088381184939	0,80
2,5	57	30	1	D-09678	0088381184946	0,85
3,0	61	33	1	D-09684	0088381184953	0,85
3,5	70	39	1	D-09690	0088381184960	1,10
4,0	75	43	1	D-09709	0088381184977	1,10
4,5	80	47	1	D-09715	0088381184984	1,20
5,0	86	52	1	D-09721	0088381184991	1,45
5,5	93	57	1	D-09737	0088381185004	1,65
6,0	93	57	1	D-09743	0088381185011	1,75
6,5	101	63	1	D-09759	0088381185028	1,90
7,0	109	69	1	D-09765	0088381185035	2,25
7,5	109	69	1	D-09771	0088381185042	2,50
8,0	117	75	1	D-09787	0088381185059	3,25
8,5	117	75	1	D-09793	0088381185066	3,00
9,0	125	81	1	D-09802	0088381185073	3,55
9,5	125	81	1	D-09818	0088381185080	3,80
10,0	133	87	1	D-09824	0088381185097	4,35
10,5	133	87	1	D-09830	0088381185103	5,70
11,0	142	94	1	D-09846	0088381185110	6,00
11,5	142	94	1	D-09852	0088381185127	6,55
12,0	151	101	1	D-09868	0088381185134	7,10
12,5	151	101	1	D-09874	0088381185141	7,60
13,0	151	101	1	D-09880	0088381185158	8,20

Brocas para metal HSS-TIN DIN338



- Brocas indicadas para el taladrado de acero con resistencia máxima de 900 N/mm², metales de fundición, plásticos duros y metales no ferrosos.
- Brocas recubiertas de nitrato de titanio que reduce la fricción y consigue mayor duración de la vida de la broca.
- Brocas un 40% más rápidas que nuestra gama HSS-G.
- Una duración mayor en un 150% respecto a nuestra gama HSS-G.
- Brocas para corte en metal con un ángulo en la punta de 135°, favorece la entrada en el material consiguiendo mayor velocidad de taladrado.
- Biselado de la espiral para un corte más rápido y eficaz.
- Brocas de gran calidad para aplicaciones profesionales donde se necesite mayor velocidad.

Ø (mm)	Largo (mm)	Largo útil (mm)	Unds.	Código	EAN	P.V.P. (€)
1,5	40	18	2	D-42961	0088381405447	3,10
2	49	24	2	D-42977	0088381405454	3,10
2,5	57	30	2	D-42983	0088381405461	3,10
3	61	33	2	D-43000	0088381405485	3,10
3,5	70	39	2	D-43038	0088381405515	3,10
4	75	43	2	D-43044	0088381405522	3,10
4,5	80	47	1	D-43072	0088381405553	2,05
5	86	52	1	D-43094	0088381405577	2,30
5,5	93	57	1	D-43119	0088381405591	2,60
6	93	57	1	D-43125	0088381405607	2,85
6,5	101	63	1	D-43131	0088381405614	3,10
7	109	69	1	D-43147	0088381405621	3,10
7,5	109	69	1	D-43153	0088381405638	3,60
8	117	75	1	D-43169	0088381405645	5,40
8,5	117	75	1	D-43175	0088381405652	5,40
9	125	81	1	D-43181	0088381405669	6,70
9,5	125	81	1	D-43197	0088381405676	6,95
10	133	87	1	D-43206	0088381405683	7,20
10,5	133	87	1	D-45375	0088381407717	10,30
11	142	94	1	D-43212	0088381405690	10,30
11,5	142	94	1	D-45381	0088381407724	10,30
12	151	101	1	D-43228	0088381405706	13,40
12,5	151	101	1	D-45397	0088381407731	15,20
13	151	101	1	D-43234	0088381405713	15,95

Brocas para metal HSS-TIN 1/4" hexagonal



- Brocas indicadas para el taladrado de acero con resistencia máxima de 1.000 N/mm², aceros tratados, aceros inoxidables y metales de fundición.
- Brocas de gran duración, indicadas para los trabajos de precisión.
- Ideal para trabajos en soportes para taladros.
- Fabricadas con metal de alta calidad con un 5% de cobalto añadido.
- Brocas para corte en metales con un ángulo en la punta de 118°, que reduce el riesgo de desplazamientos de la broca durante el taladrado.
- Estas brocas son las perfectas para los trabajos más exigentes:
 - Acero Inoxidable.
 - Trabajos en todo tipo de carrocerías de automóviles.
 - Cordones de soldadura.

Ø (mm)	Largo (mm)	Largo útil (mm)	Unds.	Código	EAN	P.V.P. (€)
3,0	81	33	1	D-14928	0088381185967	1,65
3,2	85	36	1	D-14934	0088381185974	1,90
4,0	95	43	1	D-14940	0088381185981	1,90
5,0	106	52	1	D-14962	0088381186001	2,20
6,0	113	57	1	D-14978	0088381186018	3,00
6,5	121	63	1	D-17778	0088381200622	4,10
8,0	117	75	1	D-15827	0088381186988	5,70
10,0	133	87	1	D-15833	0088381186995	8,70
12,0	151	101	1	D-15849	0088381187008	11,45
13,0	151	101	1	D-15855	0088381187015	14,70

Broca remachadora HSS



Ø (mm)	Largo (mm)	Largo útil (mm)	Unds.	Código	EAN	P.V.P. (€)
3,3	50	20	10	B-56437	0088381490283	12,00

Brocas para metal HSS-CO DIN338 ★★★★★

- Brocas para el taladrado de acero con resistencia máxima de 1.000 N/mm², aceros tratados, aceros inoxidables y metales de fundición.
- Gran duración, indicadas para los trabajos de precisión. Ideal para trabajos en soportes para taladros.
- Fabricadas con metal de alta calidad con un 5% de cobalto añadido.



Ø (mm)	Largo (mm)	Largo útil (mm)	Unds.	Código	EAN	P.V.P. (€)
1,5	40	18	1	D-17289	0088381195942	1,35
2,0	49	24	1	D-17295	0088381195959	1,35
2,5	57	30	1	D-17304	0088381195966	1,40
3,0	61	33	1	D-17310	0088381195973	1,45
3,5	70	39	1	D-17332	0088381195997	1,45
4,0	75	43	1	D-17348	0088381196000	1,65
4,5	80	47	1	D-17354	0088381196017	1,90
5,0	86	52	1	D-17360	0088381196024	1,95
5,5	93	57	1	D-17376	0088381196031	2,45
6,0	93	57	1	D-17382	0088381196048	2,55
6,5	101	63	1	D-17398	0088381196055	3,00
7,0	109	69	1	D-17407	0088381196062	3,45
7,5	109	69	1	D-17413	0088381196079	4,65
8,0	117	75	1	D-17429	0088381196086	5,70
8,5	117	75	1	D-17435	0088381196093	6,00
9,0	125	81	1	D-17441	0088381196109	6,00
9,5	125	81	1	D-17457	0088381196116	8,05
10,0	133	87	1	D-17463	0088381196123	9,05
10,5	133	87	1	D-17479	0088381196130	10,10
11,0	142	94	1	D-17485	0088381196147	10,35
11,5	142	94	1	D-17491	0088381196154	12,95
12,0	151	101	1	D-17500	0088381196161	13,10
12,5	151	101	1	D-17516	0088381196178	15,55
13,0	151	101	1	D-17522	0088381196185	16,65

Brocas metal para SDS-PLUS ★★★★★



Ø (mm)	Largo (mm)	Largo útil (mm)	Unds.	Código	EAN	P.V.P. (€)
3	90	33	1	B-57401	0088381519014	3,25
3,5	100	39	1	B-57417	0088381519021	3,25
4	105	43	1	B-57423	0088381519038	3,80
4,5	110	47	1	B-57439	0088381519045	3,85
5	116	52	1	B-57445	0088381519052	4,65
5,5	123	5	1	B-57451	0088381519069	4,65
6	123	57	1	B-57467	0088381519076	4,65
6,5	131	63	1	B-57473	0088381519083	5,20

Brocas madera para SDS-PLUS ★★★



Ø (mm)	Largo (mm)	Largo útil (mm)	Unds.	Código	EAN	P.V.P. (€)
4	105	43	1	B-57489	0088381519090	3,50
5	116	52	1	B-57495	0088381519106	3,55
6	123	57	1	B-57504	0088381519113	3,50
8	147	75	1	B-57510	0088381519120	4,10
10	163	87	1	B-57526	0088381519137	4,40

Estuche brocas madera metal SDS-PLUS



Descripción	Unds.	Código	EAN	P.V.P. (€)
Juego brocas SDS-PLUS madera y metal	1	B-57532	0088381519144	13,80

Brocas cónicas ★★★

A Tipo



B Superficie

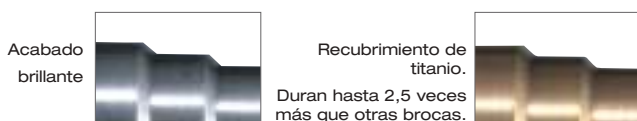

C Inserción



Ø (mm)	Flauta	Tipo	Unds.	Código	EAN	P.V.P. (€)
3-14	Recta	HSS	1	D-40048	0088381400244	17,85
4-20	Recta	HSS	1	D-40054	0088381400251	27,00
16-30,5	Recta	HSS	1	D-40060	0088381400268	50,00
24-40	Recta	HSS	1	D-40076	0088381400275	90,00

Brocas cónicas escalonadas



Ø (mm)	Flauta	Tipo	Unds.	Código	EAN	P.V.P. (€)
4-32	Recta	HSS	1	D-40107	0088381400305	68,00
4-32	Recta	HSS-TIN	1	D-40135	0088381400336	78,00
4-32	Espiral	HSS	1	D-40163	0088381400367	73,00
4-32	Espiral	HSS-TIN	1	D-40191	0088381400398	89,00



Brocas para taladro magnético HB500 y HB350

- Espiral para una buena evacuación de la rebaba. Punta de centrado que ayuda a la extracción del material una vez taladrado.
- Inserción universal de 19mm.

















Ø (mm)	Largo (mm)	Largo útil (mm)	Unds.	Código	EAN	P.V.P. (€)
12	30	19	1	12S	-	22,00
12	50	19	1	12L	-	30,00
13	30	19	1	13S	-	22,00
13	50	19	1	13L	-	31,00
14	30	19	1	14S	-	22,00
14	50	19	1	14L	-	32,00
15	30	19	1	15S	-	23,00
15	50	19	1	15L	-	33,00
16	30	19	1	16S	-	24,00
16	50	19	1	16L	-	34,00
17	30	19	1	17S	-	24,00
17	50	19	1	17L	-	35,00
18	30	19	1	18S	-	24,00
18	50	19	1	18L	-	37,00
19	30	19	1	19S	-	25,00
19	50	19	1	19L	-	39,00
20	30	19	1	20S	-	27,00
20	50	19	1	20L	-	41,00
21	30	19	1	21S	-	28,00
21	50	19	1	21L	-	44,00
22	30	19	1	22S	-	29,00
22	50	19	1	22L	-	44,00
23	30	19	1	23S	-	30,00
23	50	19	1	23L	-	46,00
24	30	19	1	24S	-	31,00
24	50	19	1	24L	-	48,00
25	30	19	1	25S	-	35,00
25	50	19	1	25L	-	50,00
26	30	19	1	26S	-	36,00
26	50	19	1	26L	-	53,00
27	30	19	1	27S	-	37,00
27	50	19	1	27L	-	56,00
28	30	19	1	28S	-	42,00
28	50	19	1	28L	-	57,00
29	30	19	1	29S	-	43,00
29	50	19	1	29L	-	60,00
30	30	19	1	30S	-	44,00
30	50	19	1	30L	-	63,00
31	30	19	1	31S	-	45,00
31	50	19	1	31L	-	65,00

Ø (mm)	Largo (mm)	Largo útil (mm)	Unds.	Código	EAN	P.V.P. (€)	
32	30	19	1	32S	-	46,00	
32	50	19	1	32L	-	68,00	
33	30	19	1	33S	-	47,00	
33	50	19	1	33L	-	73,00	
34	30	19	1	34S	-	49,00	
34	50	19	1	34L	-	74,00	
35	30	19	1	35S	-	53,00	
35	50	19	1	35L	-	77,00	
36	30	19	1	36S	-	52,00	
36	50	19	1	36L	-	80,00	
37	30	19	1	37S	-	54,00	
37	50	19	1	37L	-	83,00	
38	30	19	1	38S	-	58,00	
38	50	19	1	38L	-	84,00	
39	30	19	1	39S	-	59,00	
39	50	19	1	39L	-	93,00	
40	30	19	1	40S	-	67,00	
40	50	19	1	40L	-	98,00	
41	30	19	1	41S	-	68,00	
41	50	19	1	41L	-	102,00	
42	30	19	1	42S	-	69,00	
42	50	19	1	42L	-	104,00	
43	30	19	1	43S	-	71,00	
43	50	19	1	43L	-	107,00	
44	30	19	1	44S	-	73,00	
44	50	19	1	44L	-	111,00	
45	30	19	1	45S	-	74,00	
45	50	19	1	45L	-	124,00	
46	30	19	1	46S	-	82,00	
46	50	19	1	46L	-	128,00	
47	30	19	1	47S	-	84,00	
47	50	19	1	47L	-	136,00	
48	30	19	1	48S	-	85,00	
48	50	19	1	48L	-	141,00	
49	30	19	1	49S	-	88,00	
49	50	19	1	49L	-	143,00	
50	30	19	1	50S	-	90,00	
50	50	19	1	50L	-	145,00	
				Broca centradora 30mm	PILOTS	-	7,20
				Broca centradora 50mm	PILOTL	-	9,00

Avellanadores multimaterial

✓ : Recomendado

Descripción	A	B	C	Material					
	Fabricado con	Tipo	Inserción	Madera	Plástico	Metales no ferrosos	Hierro fundido	Acero	Acero inoxidable
7 filos 			1/4" Hex	✓	✓	✓	✓		
3 filos 			1/4" Hex (Forma-C)	✓	✓	✓	✓	✓	
5 filos 			Inserción cilíndrica	✓	✓	✓	✓	✓	
3 filos 			Inserción cilíndrica	✓	✓	✓	✓	✓	
			Inserción cilíndrica		✓	✓	✓	✓	✓

A **Fabricado en Acero**



HSS



Acero rápido con un 5% de Cobalto. Proporciona mayor dureza y resistencia a la abrasión. ideal para metales duros.

HSS-Co

B **Tipo**
 Avellanador cónico superficial.

Avellanador cónico superficial. Idóneo para láminas finas.

Avellanador cónico con vástago largo. Perfecto para avellanados de difícil acceso.

C **Inserción Cilíndrica**

1/4" Hexagonal



Avellanadores multimaterial

- Gama de avellanadores multimaterial, válidos para metal, metales no ferrosos y válidos también para madera. El avellanado es un proceso intermedio entre el taladrado y el atornillado. Se utiliza para el desarrollo de ensamblajes embutiendo la cabeza del tornillo utilizado dentro del material taladrado.
- Una vez taladrado el material se elige el avellanador más adecuado al tornillo que vamos a atornillar.
- Una vez realizado el avellanado ya podemos proceder al atornillado hasta que la cabeza del tornillo quede totalmente en línea con la superficie del material.
- Otro de los trabajos que podemos realizar con los avellanadores es la limpieza de la rebaba interior que queda en un tubo después del corte.

Avellanador cónico de acero con vástago 1/4" hexagonal

Metal, metales no ferrosos y madera.



★★

Ø (mm)	Avellanado	Longitud (mm)	Filos	Tipo	Unds.	Código	EAN	P.V.P. (€)
13	90°	50	7	Acero	1	D-37306	0088381376105	4,60

Avellanador cónico de HSS con vástago 1/4" hexagonal.

Metal, metales no ferrosos y madera.



★★★

Ø (mm)	Avellanado	Longitud (mm)	Filos	Tipo	Unds.	Código	EAN	P.V.P. (€)
6,3	M3	31	3	HSS	1	D-37312	0088381376112	6,00
8,3	M4	31	3	HSS	1	D-37328	0088381376129	7,10
10,4	M5	34	3	HSS	1	D-37334	0088381376136	8,20
12,4	M6	35	3	HSS	1	D-37340	0088381376143	8,70
16,5	M8	40	3	HSS	1	D-37356	0088381376150	13,10
20,5	M10	41	3	HSS	1	D-37362	0088381376167	15,80

Avellanador cónico de HSS con vástago cilíndrico 6mm.

Metal, metales no ferrosos y madera.



★★★

Ø (mm)	Avellanado	Longitud (mm)	Filos	Tipo	Unds.	Código	EAN	P.V.P. (€)
6	M3	48	5	HSS	1	D-37378	0088381376174	5,95
8	M4	48	5	HSS	1	D-37384	0088381376181	6,55
10	M5	40	5	HSS	1	D-37390	0088381376198	8,15
12	M6	40	5	HSS	1	D-37409	0088381376204	9,25
16	M8	43	5	HSS	1	D-37415	0088381376211	10,90
20	M10	45	5	HSS	1	D-37421	0088381376228	14,70

Avellanador cónico de HSS con vástago cilíndrico 5-6-8-10mm.

Metal, metales no ferrosos y madera.



★★★

Ø (mm)	Avellanado	Longitud (mm)	Filos	Tipo	Unds.	Código	EAN	P.V.P. (€)
6,3	M3	45	3	HSS	1	D-37437	0088381376235	6,00
8,3	M4	50	3	HSS	1	D-37443	0088381376242	7,60
10,4	M5	50	3	HSS	1	D-37459	0088381376259	8,75
12,4	M6	56	3	HSS	1	D-37465	0088381376266	9,30
16,5	M8	60	3	HSS	1	D-37471	0088381376273	12,50
20,5	M10	63	3	HSS	1	D-37487	0088381376280	16,35
25	M12	67	3	HSS	1	D-37493	0088381376297	20,15

Avellanador con orificio oblicuo HSS-Co 5% con vástago cilíndrico 6-8-10-12mm.



★★★★

Ø (mm)	Avellanado	Longitud (mm)	Filos	Tipo	Unds.	Código	EAN	P.V.P. (€)
2-5	90°	45	Agujero	HSS-Co	1	D-37502	0088381376303	10,90
5-10	90°	48	Agujero	HSS-Co	1	D-37518	0088381376310	17,85
10-15	90°	65	Agujero	HSS-Co	1	D-37524	0088381376327	27,00
15-20	90°	85	Agujero	HSS-Co	1	D-37530	0088381376334	48,00

Estuche de brocas para metal HSS-Co



★★★★★

Ø (mm)	Contenido	Unds.	Código	EAN	P.V.P. (€)
de 1 a 10mm	19 piezas	1	D-67561	0088381549196	58,00

Estuche de brocas para metal M-Force



★★★★★

Ø (mm)	Contenido	Unds.	Código	EAN	P.V.P. (€)
de 1 a 10mm	19 piezas	1	D-67583	0088381549219	62,00

Estuche de brocas para metal HSS-G



★★★

Ø (mm)	Contenido	Unds.	Código	EAN	P.V.P. (€)
de 1 a 10mm	19 piezas	1	D-67549	0088381549172	46,00

Estuche de brocas para metal HSS-TIN



★★

Ø (mm)	Contenido	Unds.	Código	EAN	P.V.P. (€)
de 1 a 10mm	19 piezas	1	D-67527	0088381548243	23,00

Estuche de brocas para metal HSS-TIN



★★

Ø (mm)	Contenido	Unds.	Código	EAN	P.V.P. (€)
de 2 a 8mm	6 piezas	1	D-72833	0088381577342	6,00

Estuche de brocas para metal HSS-R



★

Ø (mm)	Contenido	Unds.	Código	EAN	P.V.P. (€)
de 1 a 10mm	19 piezas	1	D-54081	0088381450201	18,10

Estuche de brocas para ladrillo



★★

★★★

D-72877

E-11536

Ø (mm)	Contenido	Unds.	Código	EAN	P.V.P. (€)
4, 5, 6, 8 y 10 mm	5 piezas	1	D-72877	0088381577380	5,45
4, 5, 6, 8 y 10 mm	5 piezas	1	E-11536	0088381582827	7,70



Estuche de brocas para metal, ladrillo y madera



Contenido	Total	Unds.	Código	EAN	P.V.P. (€)
6 metal	18 piezas	1	D-46202	0088381411776	21,55
6 madera					
6 ladrillo					



Contenido	Total	Unds.	Código	EAN	P.V.P. (€)
3 metal	9 piezas	1	D-71962	0088381566490	7,95
3 madera					
3 ladrillo					

Estuche de brocas para madera



Ø (mm)	Contenido	Unds.	Código	EAN	P.V.P. (€)
de 4 a 10mm	5 piezas	1	D-72861	0088381577373	4,95

Juego de brocas de pala para madera



Contenido	Unds.	Tipo	Código	EAN	P.V.P. (€)
8	1	***	E-08698	0088381579605	20,60

Estuche de brocas 1/4" hexagonal

- Madera
- Metal



Contenido	Total	Unds.	Código	EAN	P.V.P. (€)
3 metal	5 piezas	1	D-20769	0088381287760	12,05
2 madera					

- Madera
- Metal
- Ladrillo



Contenido	Total	Unds.	Código	EAN	P.V.P. (€)
2 metal	5 piezas	1	D-23759	0088381312844	9,50
2 madera					
1 ladrillo					

Estuche de brocas Omnibohrer Multimaterial

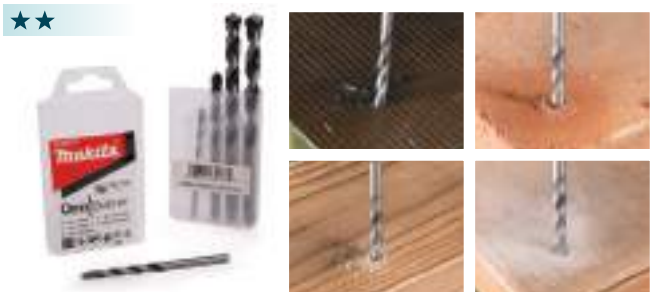

- Brocas para taladrar todo tipo de materiales ligeros como ladrillo, madera, aluminio, plástico y hormigón.
- Válidas para taladros de 2 modos. Taladro y taladro + percusión.
- Las brocas Omnibohrer de Makita son más duraderas que las brocas multimaterial de sus competidores.

Material	Hormigón	Azulejo	Ladrillo	Piezas	Cerám.	Madera	Madera + plástico	Plástico	Aluminio	Níquel
Taladro	○	○	○	○	○	○	○	○	○	○
Taladro + percusión	○	○	○	○	○	○	○	○	○	○

○ Excelente △ Bueno X No recomendable

Ø (mm)	Longitud (mm)	Unds.	Código	EAN	P.V.P. (€)
5	85	1	D-30477	0088381353335	6,60
6	100	1			
8	110	1			
10	150	1			
12	150	1			

Estuche de puntas y brocas cilíndricas

★★★



Contenido	Unds	Tipo	Código	EAN	P.V.P. (€)
29 piezas	1	***	E-07054	0088381571258	24,00

Estuche de puntas y brocas SDS-PLUS

★★★



Contenido	Unds	Código	EAN	P.V.P. (€)
18 piezas	1	E-07026	0088381571227	29,00

Set de puntas, vasos + avellanador

★★



Contenido	Unds	Código	EAN	P.V.P. (€)
Puntas, avellanadores, portabrocas magnético, llaves de vaso...	1	D-73461	0088381584821	30,00

Set de puntas + avellanador

★★



Contenido	Unds.	Código	EAN	P.V.P. (€)
Puntas, avellanadores y portabrocas magnético...	1	D-73477	0088381584838	28,00

Estuches de brocas y puntas

★★★



- 4 brocas de mampostería: 4 x 75mm, 5 x 85mm, 6 x 100mm, 8 x 120mm.
- 4 brocas para metal: 3 x 65mm, 4 x 75mm, 5 x 85mm, 6 x 95mm.
- 8 puntas de 25mm: PH2, PZ2, PH3, PZ3, Plana de 0.8 x 5.5 Plana de 1,2 x 6.5 T20, T25.
- Portapuntas magnético.

Contenido	Unds.	Código	EAN	P.V.P. (€)
17 piezas	1	D-40200	0088381401869	14,95



- Puntas 25 mm PH, PZ y T.
- Brocas pala 10 - 25 mm.
- Puntas 50 mm PH, PZ y T.
- Brocas HSS-R 1,5 - 6 mm.

Contenido	Unds.	Código	EAN	P.V.P. (€)
71 piezas	1	B-50295	0088381463317	38,00



Set de brocas con avellanador 4pcs

★★



Ø (mm)	Unds.	Código	EAN	P.V.P. (€)
6 - 8 - 10 - 12	1	D-73455	0088381584722	8,75

Maletines de accesorios



★★★

- 30 Puntas 25 mm PH, PZ, T, SL y H.
- 20 Puntas 50 mm PH, PZ, T, SL y H.
- Portabrocas magnético.
- 13 llaves de vaso.
- Llave hexagonal.
- Punzón central.
- Avellanador.
- Brocas madera 3,4,5, 5.5, 6, 6.5.
- Adaptador de corona.
- Brocas para metal HSS- TiN: 3, 4, 5, 5.5, 6, 6.5.
- Brocas para mampostería: 3, 4, 5, 5.5, 6, 6.5.
- Brocas planas hexagonales: 12, 16, 19.
- 4 brocas de corona: 32, 38, 40, 54.
- Nivel.
- Cinta métrica 3 m.
- Medidor de diámetro.
- Punta para yeso.

Contenido	Unds.	Tipo	Código	EAN	P.V.P. (€)
102 piezas	1	***	E-10730	0088381580557	54,00



★★★

- Brocas HSS-TIN: 1, 1.5, 2, 2.5, 3, 3.5, 4, 4.5, 5, 5.5, 6, 6.5 y 7mm
- Brocas para mampostería: 3, 4, 5, 5.5, 6, 6.5, 7, 8, 9 y 10mm
- Brocas para madera: 3, 4, 5, 6, 8 y 10mm
- Puntas 25 mm: PH - PZ - SL, Hex y T.
- Puntas 50 mm: PH -PZ - SL - Hex y T.
- Llaves de vaso.
- Punta Magnética para pladur 30mm
- Portapuntas magnético 60 mm.
- Avellanador 36mm.
- Topes de profundidad: 3 - 5 y 8mm
- Llave allen 2,5 mm.
- Calibre para brocas.

Contenido	Unds.	Tipo	Código	EAN	P.V.P. (€)
102 piezas	1	***	B-68432	0088381546072	44,00



★★★

- Brocas de metal 1 - 1,5 - 2 - 2,5 - 3 - 3,2 - 3,5 - 4 - 4,5 - 5 - 5,5 - 6 - 6,5 - 7 - 7,5 - 8 - 9 y 10mm.
- Brocas para mampostería: 3 - 4 - 4,5 - 5 - 5,5 - 6 - 6,5 - 7 - 8 y 10 mm.
- Brocas para madera: 3 - 4 - 5 - 6 - 7 - 8 - 9 y 10 mm.
- Brocas de pala para madera: 10 - 12 - 16 - 18 - 20 - 22 - 25 - 12 y 14 mm.
- Puntas 25 mm: PH - PZ - SL - Hex - T y SQ.
- Puntas 50 mm: PH - PZ - SL y Hex.
- Llaves de vaso.
- Avellanador 12,7.
- Portapuntas magnético 60 mm.
- Topes de profundidad: 3 - 5 - 6 - 8 y 10 mm.
- Llave allen 2,5 mm.
- Calibre para brocas.
- Brocas de corona con adaptador (mm): 32 - 38 - 44 - 54.
- Metro Makita 3mx13mm.
- Nivel.
- Destornillador magnético manual y destornillador manual.
- Botadores.
- Lápiz de carpintero.
- Portapuntas flexible.

Contenido	Unds	Tipo	Código	EAN	P.V.P. (€)
212 piezas	1	***	E-06270	0088381568746	97,00



★★★

- Brocas de metal HSS-R: 1 - 1,5 - 2 - 2,5 - 3 - 3,2 - 3,5 - 4 - 4,5 - 5 - 5,5 - 6 - 7 - 7,5 y 8 mm
- Brocas para madera: 3 - 4 - 5 - 6 - 7 - 8 - 9 y 10 mm.
- Brocas de pala para madera: 12 - 16 - 20 - 22 - 25 - 12 y 14mm.
- Brocas para mampostería: 3 - 4 - 4,5 - 5 - 6 - 7 - 8 y 10mm.
- Avellanador 36.
- Puntas 25 mm: PH - PZ - SL - T y H3
- Puntas 50 mm: PH y PZ.
- Adaptador de cambio de inserción 1/4" 3/8"
- Portapuntas magnético 60 - 80mm.
- Llaves de vaso.
- Brocas de corona
- Adaptador de brocas de corona 90mm
- Calibre para brocas.
- Llave allen 2,5 mm.
- Topes de profundidad: 3 - 5 - 6 - 8 y 10 mm
- Set de llaves allen (mm)
- Set de llaves allen (pulgadas)
- Metro Makita 3mx13mm.
- Cúter
- Nivel.
- Desatornillador manual
- Llave ajustable
- Lápiz de carpintero 150 mm.
- Punta magnética para tabiquería seca.

Contenido	Unds	Tipo	Código	EAN	P.V.P. (€)
216 piezas	1	***	E-11689	0088381585019	113,00

Maletín de accesorios



★★★

- Puntas 25 mm PH, PZ, T, SL y H.
- Estuche 25 puntas 25 mm PZ2.
- Puntas 60 mm PH, PZ y T.
- Portapuntas 60mm 1/4".
- Avellanador 1/4".
- Llave de vaso 1/4 Hex. 6, 8 y 10 mm.
- Brocas madera 3, 4, 5, 6 y 8 mm.
- Brocas widia 6, 7 y 8 mm.
- Brocas pala 12 y 16 mm.
- Brocas corona Bi-metal 32 y 38 mm.
- Adaptador corona.
- Brocas HSS 2, 3, 4, 5 y 8 mm.

Contenido	Unds.	Tipo	Código	EAN	P.V.P. (€)
100 piezas	1	***	B-54520	0088381477802	53,00

Maletines de accesorios Maccess

MACCESS

- Estuche 34 piezas:
- Brocas de metal HSS-R.
- Llaves de vaso.
- Portapuntas magnético
- Brocas para mampostería.
- Avellanador.
- Brocas para madera.
- Puntas de varias medidas.

★★★★★

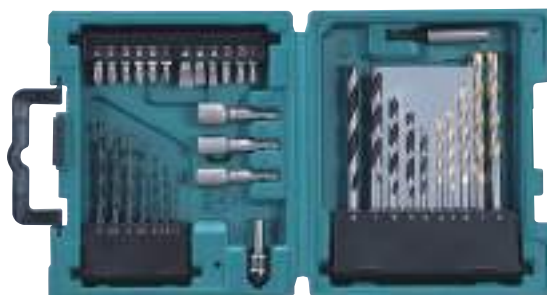

Contenido	Unds.	Código	EAN	P.V.P. (€)
34 piezas	1	D-36980	0088381374248	27,00

★★★★★



- Estuche 71 piezas:
- Brocas de metal HSS-Tin.
- Brocas para mampostería.
- Brocas para madera.
- Brocas de pala.
- Avellanador.
- Cinta métrica (3M).
- Cuchilla.
- Portapuntas magnético.
- Llaves de vaso
- Destornillador.
- Puntas de varias medidas.

Contenido	Unds.	Código	EAN	P.V.P. (€)
71 piezas	1	D-33691	0088381360586	68,00

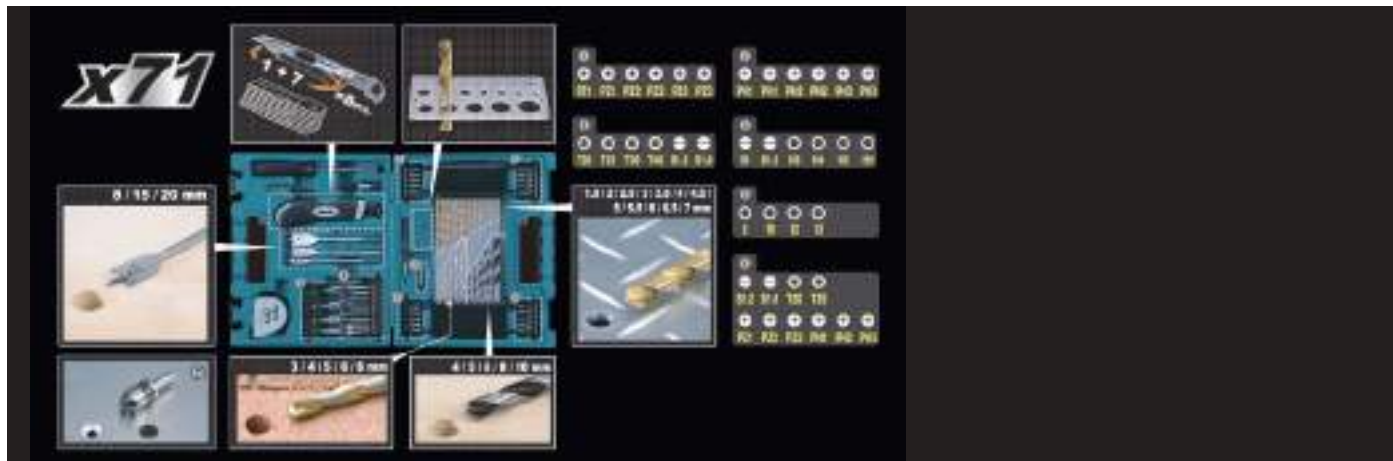

Maletines de accesorios Maccess

★★★★



- Estuche 104 piezas:
- Brocas de metal HSS-Tin.
- Brocas para mampostería.
- Brocas para madera.
- Brocas de pala.
- Avellanador.
- Metro (3m).
- Cúter.
- Portapuntas magnético.
- Llaves de vaso.
- Destornillador.
- Topes de profundidad.
- Nivel.
- Puntas de varias medidas.



Contenido	Unds.	Código	EAN	P.V.P. (€)
104 piezas	1	D-31778	0088381358590	89,00

x104

8 / 15 / 20 mm

1 + 7 = 8 pcs.

1.5 / 2 / 2.5 / 3 / 3.5 / 4 / 4.5 / 5 / 5.5 / 6 / 6.5 / 7 / 8 / 10 mm

3 / 4 / 5 / 6 / 7 / 8 / 10 mm

Estuches de accesorios Maccess



- Estuche 200 piezas:
- Brocas de metal HSS-Tin.
- Brocas para mampostería.
- Brocas para madera.
- Brocas de pala.
- Avellanador.
- Cinta métrica (5M).
- Cuchilla.
- Portapuntas magnético.
- Llaves de vaso.
- Destornillador.
- Topes de profundidad.
- Nivel.
- Extensores de atornillado.
- Llave inglesa.
- Brocas de corona.
- Alicata de punta.
- Alicata cortador.
- Linterna.
- Puntas de varias medidas.



Contenido	Unds.	Código	EAN	P.V.P. (€)
200 piezas	1	D-37194	0088381375399	152,00

X200

300 mm

3-5/8/10 mm

M6

90°

8/15/20 mm

LED

5/5.5/6/7/8/9/10/11/12/13 mm

No incluida

3/4/5/6 mm 8x300/10x300 mm

3/4/5/6/7/8/10 mm

4/5/6/7/8/9/10/11/12/13/14/15/16/17/18 mm

5/6/7/8/9/10/11/13 mm

32/38/45/54/68 mm

Diagram showing various tools and their specifications, including drill bits, sockets, wrenches, pliers, and a level.



Estuches de accesorios Makpac

Set de accesorios Makpac B-69478:
Makpac tipo 1.

- Brocas SDS-PLUS para metal HSS-TIN:
 - 3x 90, 3.5x 100, 4x 105, 4.5x 110, 5x 116, 5.5x 123, 6x 123, 6.5x 131mm.
- Brocas SDS-PLUS:
 - 6x 160, 7x 160, 8x 160, 10x 160, 12x 160mm.
- Brocas para madera:
 - 4x 105, 5x 116, 6x 123, 8x 147, 10x 163, 12x 160mm.
- Puntas:
 - 2x PH0, 2x PH1, 3x PH, 3x PH3.
 - 2x PZ0, 2x PZ1, 2x PZ3, 2x PZ3.
 - 2x SL4, 2x SL5, 2x SL5.5, 2xSL6.5.
 - H3, H4, H5, H6
 - T10, T15, 2xT20, 2x T25, T30, T40.
- Llaves de vaso:
 - 8, 10, 12, 13mm.
- Avellanador.
- Portapuntas 80mm SDS-PLUS.
- Cinta métrica 3M.



★★★★

Contenido	Unds.	Código	EAN	P.V.P. (€)
65 piezas	1	B-69478	0088381548731	110,00

Set de accesorios Makpac B-49638:
Makpac tipo 1.

- Estuche de puntas 25mm.
 - Portapuntas 60 mm
 - PH0, PH1, 2x PH2, PH3.
 - PZ0, PZ1, 2x PZ2, PZ3.
 - SL4, SL4.5, SL5.5, SL6.5.
 - T10, 2x T15, 2xT20, 2x T25, T27, 2x T30, T40.
 - T10H, T15H, T25H, T27H, T30H, T40H.
 - H3, H4, H5, H6.
- Pack de puntas PH2/PZ2 50 mm:
 - 5x PH2.
 - 5x PZ2.
- Portapuntas magnético 1/4 Hex tipo "click".
- Llaves de vaso: 6/8/10/12/13 mm.
- Brocas de pala: 16/20 mm.
- Brocas de madera: 3/4/5/6/8 mm.
- Brocas de metal HSS-G: 3/4/5/6/8 mm.
- Brocas mampostería HM: 5/6/8/10 mm.
- Bandeja para colocación de accesorios.



★★★★

Contenido	Unds.	Código	EAN	P.V.P. (€)
69 piezas	1	B-49638	0088381459631	110,00

Set de accesorios Makpac B-49725:
Makpac tipo 1.

- 2 Estuches puntas 25 mm.
 - Portapuntas 60 mm:
 - PH0, PH1, 2x PH2 y PH3.
 - PZ0, PZ1, 2x PZ2 y PZ3.
 - SL4, SL4.5, SL5.5 y SL6.5.
 - H3, H4, H5 y H6.
 - T10, 2x T15, 2x T20, 2x T25, T27, 2x T30 y T40.
 - T10H, T15H, T25H, T27H, T30H y T40H.
 - Mango portapuntas.
- Estuche brocas D-46202.
 - Brocas metal HSS-G: 3/4/5/6/8/10 mm.
 - Brocas madera: 3/4/5/6/8/10 mm.
 - Brocas mampostería HMCT: 3/4/5/6/8/10 mm.
- Cintra métrica.
- Cutter (con recambios de hoja).
- Destornillador de carraca.



★★★★

Contenido	Unds.	Código	EAN	P.V.P. (€)
96 piezas	1	B-49725	0088381460965	139,00

Set de accesorios Makpac B-49884:
Makpac tipo 1.

- Estuche brocas D-46202.
 - Brocas metal HSS-G: 3/4/5/6/8/10 mm.
 - Brocas madera: 3/4/5/6/8/10 mm.
 - Brocas mampostería HMCT: 3/4/5/6/8/10 mm.
- Estuche de brocas, puntas y vasos.
 - Brocas metal HSS-G: 3/4/5/6/8/10 mm.
 - Puntas 25mm:
 - 2x PH1, 2x PH2 y PH3.
 - 2x PZ1, 2x PZ2 y PZ3.
 - T10, 2x T15, 2x T20, 2xT25, 2x T30 y T40.
 - SL4.5, 2x SL5.5 y 2x SL6.5.
 - H2, H2.5, H3, H4, 2x H5 y 2x H6.
 - Llaves de vaso 1/4 Hex: 4/5/6/8/10 mm.
 - Portapuntas magnético 1/4 Hex tipo "click".
- Estuche puntas y llaves de vaso:
 - Puntas 25mm:
 - 2x PH1, 2x PH2 y PH3.
 - 2x PZ1, 2x PZ2 y PZ3.
 - T10, 2x T15, 2x T20, 2xT25, 2x T30 y T40.
 - 2x SL4.5, 2x SL5.5 y 2x SL6.5.
 - H2, H2.5, H3, H4, 2x H5 y 2x H6.
 - Llaves de vaso 1/4 Hex: 4/5/6/8/10 mm.
 - Portapuntas magnético 1/4 Hex tipo "click".
 - Destornillador de carraca.
- Cintra métrica 3m.
- Cutter (con recambios de hoja).
- Linterna LED (sin pila).



★★★★

Contenido	Unds.	Código	EAN	P.V.P. (€)
116 piezas	1	B-49884	0088381462037	149,00

Brocas de corona

Aplicación	Aluminio	Acero inoxidable	PVC	Acero	Metales no ferrosos	Madera	Epoxy
✓ Recomendado • Válido							
Ezychange	✓	•	•	✓	✓	•	
BIM	•		✓	✓	•	✓	
TCT	•	✓	✓	✓	•		✓
Consejos	Usar aceite de corte	Bajas Rpm usar con aceite de corte		Usar aceite de corte	Usar aceite de corte		

Brocas de corona Bi-Metálicas



Aplicación:
Para acero, hierro, metal, madera o plásticos.

Ø (mm)	Largo (mm)	Largo útil (mm)	Unds.	Código	EAN	P.V.P. (€)
14	50	38	1	D-35368	0088381369015	3,40
16	50	38	1	D-16994	0088381194792	3,50
17	50	38	1	D-35374	0088381369022	4,00
19	50	38	1	D-17005	0088381194808	3,95
20	50	38	1	D-17251	0088381195805	4,25
21	50	38	1	D-35380	0088381369039	4,50
22	50	38	1	D-17011	0088381194815	4,50
24	50	38	1	D-17027	0088381194822	5,10
25	50	38	1	D-17033	0088381194839	5,10
27	50	38	1	D-35396	0088381369046	5,10
29	50	38	1	D-17267	0088381195812	5,10
30	50	38	1	D-35405	0088381369053	5,35
32	44	38	1	D-17049	0088381194853	5,40
33	44	38	1	D-35411	0088381369060	5,65
35	44	38	1	D-17055	0088381194860	5,95
37	44	38	1	D-35427	0088381369077	5,95
38	44	38	1	D-17061	0088381194877	5,95
40	44	38	1	D-17273	0088381195829	6,25
41	44	38	1	D-35433	0088381369084	6,50
43	44	38	1	D-35449	0088381369091	6,80
44	44	38	1	D-17077	0088381194884	6,80
46	44	38	1	D-35455	0088381369107	7,35
48	44	38	1	D-35461	0088381369114	7,65
51	44	38	1	D-17083	0088381194891	7,95
52	44	38	1	D-35477	0088381369121	7,65
54	44	38	1	D-24876	0088381334778	7,65

Ø (mm)	Largo (mm)	Largo útil (mm)	Unds.	Código	EAN	P.V.P. (€)
56	44	38	1	D-35483	0088381369138	8,30
57	44	38	1	D-17099	0088381194907	8,30
59	44	38	1	D-35499	0088381369145	8,30
60	44	38	1	D-25688	0088381338516	8,35
64	44	38	1	D-30140	0088381351263	8,90
65	44	38	1	D-24882	0088381334785	8,85
67	44	38	1	D-35508	0088381369152	9,50
68	44	38	1	D-17108	0088381194914	9,55
70	44	38	1	D-25694	0088381338523	10,20
73	44	38	1	D-35514	0088381369169	10,50
76	44	38	1	D-17114	0088381194921	10,75
79	44	38	1	D-35520	0088381369176	10,75
83	44	38	1	D-17120	0088381194938	11,05
86	44	38	1	D-35536	0088381369183	11,05
89	44	38	1	D-35542	0088381369190	11,90
92	44	38	1	D-17136	0088381194945	11,90
95	44	38	1	D-35558	0088381369206	12,15
98	44	38	1	D-35564	0088381369213	12,45
102	44	38	1	D-35570	0088381369220	13,15
105	44	38	1	D-17142	0088381194952	13,60
108	44	38	1	D-35586	0088381369237	15,00
111	44	38	1	D-35592	0088381369244	15,55
114	44	38	1	D-35601	0088381369251	16,15
121	44	38	1	D-35617	0088381369268	16,70
127	44	38	1	D-17158	0088381194969	17,25
140	44	38	1	D-35623	0088381369275	18,95
152	44	38	1	D-17164	0088381194983	20,40

Brocas de corona



Adaptador con broca de centrado para coronas Bi-Metálicas



Ø (mm)	Tipo	Unds.	Código	EAN	P.V.P. (€)
14-29	10 Hex	1	D-17170	0088381194976	4,05
32-152	13 Hex	1	D-17186	0088381195003	7,35
14-29	SDS-PLUS	1	D-17603	0088381196727	5,95
32-76	SDS-PLUS	1	D-17619	0088381196734	9,70



Broca de centrado para coronas Bi-Metálicas



Ø (mm)	Longitud (mm)	Unds.	Código	EAN	P.V.P. (€)
6	71	1	D-17192	0088381194990	2,95

Estuches de brocas de corona Bi-Metálicas



D-47298

Ø (mm)	Uso	Unds.	Código	EAN	P.V.P. (€)
19, 22, 25, 29, 35, 44, 51, 57, 68 y 75	Fontanería	1	D-47298	0088381424370	102,00
19, 22, 29, 38, 44 y 57	Fontanería	1	D-47117	0088381423731	45,00



D-47117



D-47123

Ø (mm)	Uso	Unds.	Código	EAN	P.V.P. (€)
16, 20, 25, 32, 40 y 51	Electricidad	1	D-47123	0088381423748	38,00
20, 25, 32, 40, 51 y 65	Electricidad	1	D-47139	0088381423755	45,00

Brocas de corona Ezychange



Brocas Bi-metálicas con cobalto válidas para: madera, metal, aluminio, acero inoxidable y plástico.



ALTA CALIDAD con un 8% de COBALTO PARA UNA MAYOR DURACIÓN

Ø (mm)	Largo (mm)	Largo útil (mm)	Unds.	Código	EAN	P.V.P. (€)
16	46	40	1	B-11265*	0088381352314	8,00
17	46	40	1	B-31706	0088381419161	8,00
19	46	40	1	E-03654	0088381561891	8,00
20	46	40	1	E-03660	0088381561907	8,00
22	46	40	1	E-03676	0088381561914	8,50
25	46	40	1	E-03698	0088381561938	10,30
27	46	40	1	E-03707	0088381561945	9,80
29	46	40	1	E-03713	0088381561952	9,80
32	46	40	1	E-03735	0088381561976	10,20
37	46	40	1	E-03757	0088381561990	10,80
38	46	40	1	E-03763	0088381562003	10,30
40	46	40	1	E-03779	0088381562010	11,35
41	46	40	1	E-03785	0088381562027	11,35
44	46	40	1	E-03791	0088381562034	11,85
46	46	40	1	E-03800	0088381562041	11,85
51	46	40	1	E-03822	0088381562065	12,35

Ø (mm)	Largo (mm)	Largo útil (mm)	Unds.	Código	EAN	P.V.P. (€)
52	46	40	1	E-03838	0088381562072	13,15
56	46	40	1	E-03850	0088381562096	14,15
60	46	40	1	E-03872	0088381562119	14,15
66	46	40	1	E-03894	0088381562133	15,00
73	46	40	1	E-03925	0088381562164	16,20
76	46	40	1	E-03931	0088381562171	16,20
79	46	40	1	E-03947	0088381562188	18,55
83	46	40	1	E-03953	0088381562195	19,05
86	46	40	1	E-03969	0088381562201	19,55
95	46	40	1	E-03981	0088381562225	25,00
105	46	40	1	E-04008	0088381562249	25,00
111	46	40	1	E-04014	0088381562256	32,00
114	46	40	1	E-04020	0088381562263	32,00
121	46	40	1	E-04036	0088381562270	36,00
127	46	40	1	E-04042	0088381562287	32,00
152	46	40	1	E-04064	0088381562300	42,00

* azul Makita

Adaptadores para coronas Ezychange



Tipo	Contenido	Unds.	Código	EAN	P.V.P. (€)
Cilíndrico	Con broca de centrado	1	E-04070	0088381562317	24,00

Broca de centrado



Tipo	Unds.	Código	EAN	P.V.P. (€)
HSS	1	E-04086	0088381562324	6,45

Brocas de corona HM

Brocas de corona metal duro (alta durabilidad).

Con pastillas de metal duro, preparada para soportar altas temperaturas producidas por cortes profundos y continuos.

Para chapa de acero, acero inox, vigas de hierro (doble t), etc.

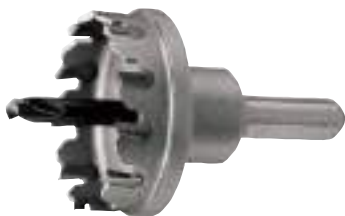

* Para taladros superiores a 4mm de espesor se recomienda refrigerar la broca.



Ø (mm)	Inserción (mm)	Tipo	Unds.	Código	EAN	P.V.P. (€)
16	6	HM	1	B-00898	008838114004	49,00
18	6	HM	1	B-00907	008838114011	51,00
20	6	HM	1	B-00913	008838114028	51,00
21	6	HM	1	B-00929	008838114035	51,00
22	6	HM	1	B-00935	008838114042	51,00
25	10	HM	1	B-00941	008838114059	51,00
27	10	HM	1	B-00957	008838114066	52,00
30	10	HM	1	B-00979	008838114080	54,00
32	10	HM	1	B-00985	008838114097	63,00
35	10	HM	1	B-00991	008838114103	63,00
38	10	HM	1	B-01002	008838114110	74,00
40	10	HM	1	B-01018	008838114127	75,00
45	10	HM	1	B-01024	008838114134	82,00
48	10	HM	1	B-01030	008838114141	91,00
50	10	HM	1	B-01046	008838114158	94,00
60	13	HM	1	B-01068	008838114172	134,00
90	13	HM	1	B-01127	008838114288	236,00

Brocas de centrado para brocas HM



Ø (mm)	Tipo	Uso	Unds.	Código	EAN	P.V.P. (€)
6	HSS	Acero	1	B-01177	008838114233	9,80
8	HSS	Acero	1	B-01183	008838114240	10,30
6	HM	Resina, FRP...	1	B-01199	008838114301	11,85
8	HM	Resina, FRP...	1	B-01208	008838114318	14,40

Batidores

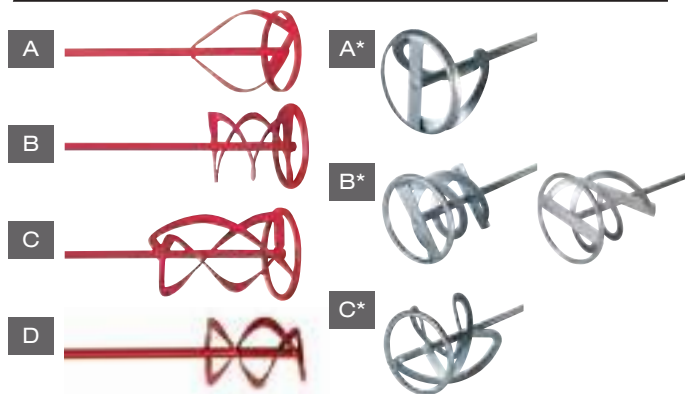

A	Para pinturas, lacas, yeso, revestimientos finos, etc.
B y D	Todos los materiales viscosos, conveniente para todos los tipos de mortero, yeso, resinas de epoxi llenadas por cuarzo, etc.
C	Para todos los materiales pegajosos y viscosos, por ejemplo pegamentos de azulejo, morteros, yesos, rellenos, etc.

Inser.	Ø (mm)	Long. (mm)	Tipo	Modelos	Unds.	Código	EAN	P.V.P. (€)	
8	80	400	A	DA6301 DS4010	1	P-02331	0088381918527	14,40	
10	90	400	D		1	P-02347	0088381918534	13,90	
8	100	590	C	UT1200 UT1400 UT1401 UT1600	1	P-02353	0088381918541	32,00	
M14	90	590	D		1	P-22028	0088381949088	25,00	
M14	120	590	A		1	P-22012	0088381949071	24,00	
M14	140	590	B		1	P-22040	0088381949101	31,00	
M14	120	590	C		1	P-22056	0088381949118	36,00	
M14	120	600	A*		1	D-73508	0088381584869	16,20	
M14	120	600	B*		1	D-73514	0088381584876	17,35	
M14	120	600	C*		1	D-73520	0088381584883	17,35	
10	120	600	B*		DA6301 DS4010	1	D-73542	0088381584906	10,40

Adaptadores para batidores



Modo de empleo: Para utilizar batidor de inserción M14 en un taladro, es necesario desmontar el portabrocas, en su lugar colocar el adaptador y en el otro extremo insertar el batidor que más convenga para el tipo de trabajo.

Ø (mm)	Inserción	Modelo	Unds.	Código	EAN	P.V.P. (€)
1/2"	M14	6013B/ DP4002	1	P-22062	0088381949125	10,30
5/8"	M14	DA6301	1	P-02325	0088381918510	10,30

Disco mezclador (sin varilla A-43751)



Ø (mm)	Inserción	Modelo	Unds.	Código	EAN	P.V.P. (€)
165 mm	M8	DUT130	1	A-43692	0088381198707	13,45

Varilla para mezclador inox. A-43692



Ø (mm)	Inserción	Modelo	Unds.	Código	EAN	P.V.P. (€)
1/2"	M14	6013B/ DP4002	1	A-43751	0088381198769	26,00



Extensión DA4000LR



DA4000LR con extensión.

Modelos	Longitud (mm)	Unds.	Código	EAN	P.V.P. (€)
DA4000LR	760	1	193317-9	0088381160971	235,00

Topes de profundidad



Modelos	Unds.	Código	EAN	P.V.P. (€)
DP2010 DP2011	1	322177-4	0088381126441	1,10
HP1620/1 HP2033 HP2050/1 HP2070/1	1	415486-9	0088381147033	0,90
DP4011	1	324219-0	0088381171458	1,85



Soporte de taladro y accesorios

Soporte de taladro

[a]



*Eurocuello 43 mm.

Unds.	Código	EAN	P.V.P. (€)
1	A-36706*	0088381183130	370,00

Soporte de tope horizontal

[b]

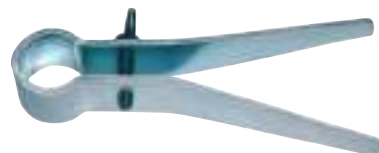

Unds.	Código	EAN	P.V.P. (€)
1	501329	-	34,00

Mordaza horizontal

[c]

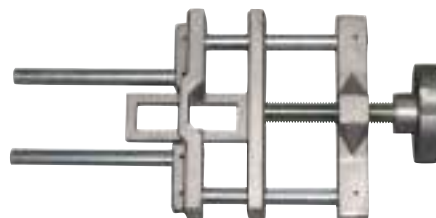

Unds.	Código	EAN	P.V.P. (€)
1	132126-1	-	158,00



Soporte de guía y accesorios

Soporte de guía

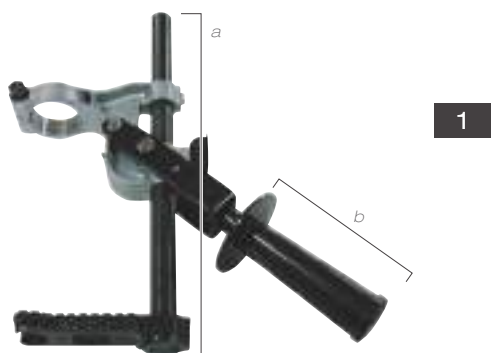

Despiece	Unds.	Código	EAN	P.V.P. (€)
[a] Garra: 134279-2	1	501353	-	162,00
[b] Empuñadura: 273466-9				

Base en "V"

Para utilizar con SOPORTE GUÍA 501353



Despiece	Unds.	Código	EAN	P.V.P. (€)
[a] Base en V: 163221-6	1	501036	-	10,30
[b] Tornillo: 911321-4				

Kit de soporte (base + palanca)



Kit completo
(máquina no incluida)

Despiece	Unds.	Código	EAN	P.V.P. (€)
[1+2] Kit completo	1	501043	-	185,00
[a] Palanca: 155696-3	1	501035	-	25,00
[b] Tornillo: 924306-1				
[c] Tornillos (2Unds.): 912317-8				
[d] Base: 342802-1				

Tope de ajuste

Para utilizar con SOPORTE GUÍA 501353



Despiece	Unds.	Código	EAN	P.V.P. (€)
[a] Arandela: 941101-4	1	501037	-	4,40
[b] Tornillo: 251259-4				
[c] Tope: 342804-7				



Alargador de base

Para utilizar con SOPORTE GUÍA 501353



Despiece	Unds.	Código	EAN	P.V.P. (€)
[a] Tornillo (2Unds.): 911321-4	1	501038	-	4,65
[b] Suplemento: 342818-6				

Portabrocas automático

Tipo	Imagen	Modelos	Capacidad (mm)	Paso	Cierre / llave	Unds.	Código	EAN	P.V.P. (€)
Automático		HP1631 6310 HP1641	1,5 - 13	1/2" - 20	Lock	1	P-15718	0088381932202	36,00
		HP2051 HP2071 DP4011	1,5 - 13	1/2" - 20	Carraca	1	194254-0	0088381206907	48,00
		6317D 6337D 6347D	1,5 - 13	1/2" - 20	Estándar	1	766010-4	-	29,00
		DP3003	1,0 - 10	1/2" - 20	Lock	1	193226-2	0088381150347	33,00
		6501X DP2011	0,8 - 6,5	3/8" - 24	Estándar	1	193203-4	0088381157285	34,00
		6413	1,0 - 10	3/8" - 24	Estándar	1	763180-0	0088381189156	9,30
		6408 DA3011F	1,0 - 10	3/8" - 24	Lock	1	192282-9	0088381119832	31,00
		DF331D	1,0 - 10	3/8" - 24	-	1	763228-8	-	11,55
		HP331D	1,0 - 10	3/8" - 24	-	1	763229-6	-	9,40
		6261D 6271D 6281D	0,8 - 10	3/8" - 24	-	1	766002-3	0088381350549	9,80
		DF330D	0,8 - 10	3/8" - 24	-	1	766007-3	0088381354219	10,80
		8270D 8280D	0,8 - 10	1/2" - 20	-	1	763187-6	0088381196192	14,40
		6260D 6270D 6280D	0,8 - 10	1/2" - 20	-	1	763185-0	0088381192873	10,60
		8391D	0,8 - 10	1/2" - 20	-	1	766004-9	0088381359825	14,05

Portabrocas manual

Tipo	Imagen	Modelos	Capacidad (mm)	Paso	Cierre / llave	Unds.	Código	EAN	P.V.P. (€)
Manual		6501 DP2010	0,5 - 6,5	3/8" - 24	763435-3	1	763077-3	0088381114837	5,20
		6413 6408 DA3011F	1,0 - 10	3/8" - 24	-	1	P-11835*	-	12,35
		HP1620	1,5 -13,0	1/2" - 20	763440-0	1	196008-1*	0088381433792	11,35
		HP1640	1,5 -13,0	1/2" - 20	763448-4	1	766016-2	-	9,00
		HP2050 HP2070 DS4012	1,5 -13,0	1/2" - 20	763430-3	1	193822-6*	0088381184250	26,00
		HP2010N 6300-4 6013B	1,5 -13,0	1/2" - 20	763432-9	1	192877-8	0088381147934	35,00
		DP4000 DP4002	1,5 -13,0	1/2" - 20	763434-5	1	193228-8	0088381158183	37,00
		DP3002	1,0 - 10,0	1/2" - 20	763434-5	1	193224-6	0088381158176	40,00
		DA4031	2,0 - 13,0	***	763432-9	1	193519-7	0088381164597	51,00
		DA6301	1,5 - 13,0	5/8" - 16	763432-9	1	763062-6	0088381102223	42,00
		DA4000LR	2,0 - 13,0	***	763432-9	1	193318-7	0088381160957	48,00
		DA3010F	1,0 - 10,0	**	763415-9	1	763174-5	0088381181945	38,00
		MT603	1,0 - 10,0			1	193706-8	0088381193078	6,70



Atornillado

IMPACT BLACK



Impact
PREMIER



Tabla de contenido

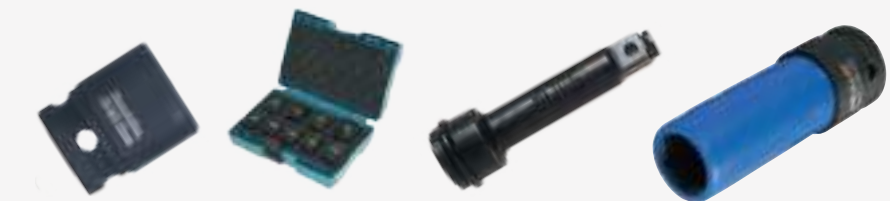
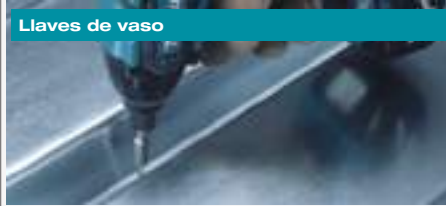
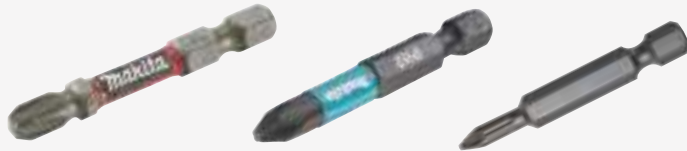

Impact
PREMIER



Mayor precisión de encaje.

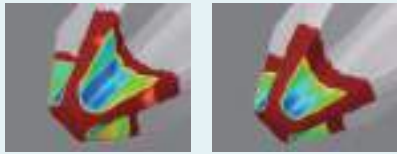

Con un tornillo cerca

Con un tornillo a distancia



Impact
PREMIER

Estándar

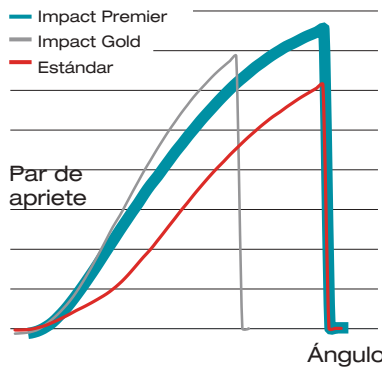

Doble torsión que consigue mayor durabilidad.



Sierra de sable de diente japonés



Dientes japoneses de 0,6mm de grosor para un corte más limpio del material.

Sierra de diente japonés:

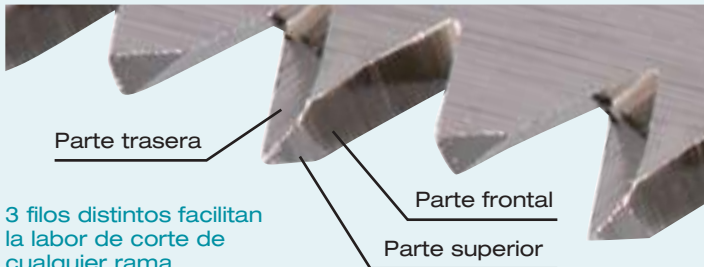

3 filos distintos facilitan la labor de corte de cualquier rama.

Calidad superior



Acabado con diente japonés



Acabado con diente normal



Hilo de nylon de cuatro hojas

Cuatro hojas

Forma de cuatro hojas que reduce el ruido y aumenta el tiempo de trabajo.



Características

La forma del hilo de cuatro hojas crea un pequeño vértice que reduce el ruido del corte y alarga el tiempo trabajo debido a que ejerce menos resistencia.

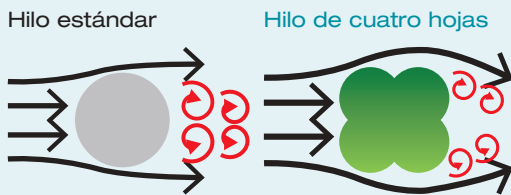

Cantidad de cortes por una carga

Ruido

120
100

20% más

90,5dB
97dB

6,5dB menos



Redondo



Cuatro hojas



Redondo



Cuatro hojas



Cadena para sierras serie 80



Características

Forma de corte óptima para corte suave

Paso de cadena corto para reducir la vibración

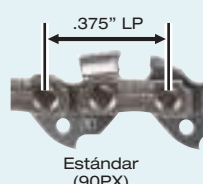
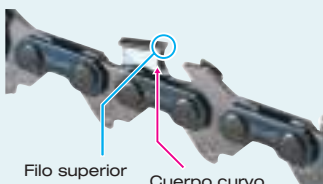

Vibración



Serie 80



90PX



Serie 80



85
100

15% menos

Cantidad de cortes por una carga

125
100

20% más

Impact PREMIER



Presentamos nuestra mejor gama de puntas, portapuntas y llaves de vaso **IMPACT PREMIER**, una gama rediseñada que eleva la dureza y mejora la calidad y durabilidad de nuestros accesorios.

- La nueva forma de torsión hace que esta gama sea perfecta para trabajos con atornilladores de impacto.
- Ofrecen un gran ajuste de la punta en el tornillo.
- Cada tipo de punta está diferenciada por un color para el reconocimiento sencillo de cada una.

Puntas Impact Premier



- Nuevo código de color: Cada tipo de punta tiene un color asociado.

★★★★★



E-03280

E-03296

E-03355

Punta	Tipo	Longitud (mm)	Unds.	Código	EAN	P.V.P. (€)
PH ⊕	PH1	25	2	E-03121	0088381569798	3,10
	PH2	25	2	E-03137	0088381569804	3,10
	PH3	25	2	E-03159	0088381569828	3,10
	PH1	50	2	E-03268	0088381569934	6,20
	PH2	50	2	E-03274	0088381569941	6,20
	PH3	50	2	E-03280	0088381570244	6,20
PZ ⊗	PZ1	25	2	E-03165	0088381569835	3,10
	PZ2	25	2	E-03171	0088381569842	3,10
	PZ3	25	2	E-03187	0088381569859	3,10
	PZ1	50	2	E-03296	0088381569958	6,20
	PZ2	50	2	E-03305	0088381569965	6,20
	PZ3	50	2	E-03311	0088381569972	6,20
T ⊕	T10	25	2	E-03193	0088381569866	3,10
	T15	25	2	E-03202	0088381569873	3,10
	T20	25	2	E-03218	0088381569880	3,10
	T25	25	2	E-03224	0088381569897	3,10
	T30	25	2	E-03230	0088381569903	3,10
	T40	25	2	E-12027	0088381585163	4,90
	T10	50	2	E-03327	0088381569989	6,20
	T15	50	2	E-03333	0088381569996	6,20
	T20	50	2	E-03349	0088381570008	6,20
	T25	50	2	E-03355	0088381570015	6,20
T30	50	2	E-03361	0088381570022	6,20	

MagBoost

★★★★★



Mag Boost: portapuntas magnético 25mm.

- Proporciona un imantado extra para una fijación fuerte del tornillo.
- A diferencia del Ultramag, el Mag Boost no es un portapuntas, si no que se acopla a la punta directamente.
- Las puntas han de tener un mínimo de 50mm. Ideal para puntas largas ya sea cual sea la longitud, siempre se puede colocar a pocos milímetros de la cabeza.
- Tiene inserción cilíndrica por lo que también es compatible con atornilladores manuales (6,35mm de diámetro, 1/4" Hex.).



Descripción	Longitud (mm)	Unds.	Código	EAN	P.V.P. (€)
Imán	25	1	E-03442	0088381570107	4,10

Portapuntas Ultramag Impact Premier

★★★★★



Tipo	Long. (mm)	Inserción	Unds.	Código	EAN	P.V.P. (€)
Imantado Neodimio	79	1/4"	1	E-03414	0088381570077	9,25

Estuche de puntas Impact Premier

- Portapuntas.
- Puntas PH: PH2.
- Puntas PZ: Pz1, 2x Pz2 y Pz3.
- Puntas T: T20, T25 y T30.
- Puntas planas: SL4 y SL6.

★★★★★



Contenido	Unds.	Código	EAN	P.V.P. (€)
11 piezas	1	E-03573	0088381570213	23,00

Adaptador móvil

★★★★★



E-03420

E-03436

Inserción	Longitud (mm)	Unds.	Código	EAN	P.V.P. (€)
1/4" - 3/8"	56	1	E-03420	0088381570084	6,20
1/4" - 1/2"	56	1	E-03436	0088381570091	6,20

Puntas dobles Impact Premier

★★★★★



Punta	Tipo	Longitud (mm)	Unds.	Código	EAN	P.V.P. (€)
PH	PH2	65	2	E-06286	0088381570220	9,25
PZ	PZ2	65	2	E-06292	0088381570237	9,25

Portapuntas torsión Impact Premier

★★★★★



Tipo	Long. (mm)	Inserción	Unds.	Código	EAN	P.V.P. (€)
Imantado	66	1/4"	1	E-03399	0088381570053	8,00
Imantado	150	1/4"	1	E-03408	0088381570060	8,75

Llaves de vaso móviles Impact Premier

★★★★★



Tornillo	Ø (mm)	Largo (mm)	Unds.	Código	EAN	P.V.P. (€)
M8	13	80	1	E-03492	0088381570152	8,75
M10	17	80	1	E-03517	0088381570176	9,25
M12	19	80	1	E-03523	0088381570183	9,55

Llaves de vaso imantadas Impact Premier

★★★★★



Tornillo	Ø (mm)	Largo (mm)	Unds.	Código	EAN	P.V.P. (€)
M3,5	6	65	1	E-03458	0088381570114	6,20
M5	8	65	1	E-03464	0088381570121	6,20
M6	10	65	1	E-03470	0088381570138	6,20
M8	13	65	1	E-03486	0088381570145	6,45

Puntas para atornillar Impact Black



Estuche de puntas y llaves de vaso Impact Black

★★★



Punta	Unds.	Código	EAN	P.V.P. (€)
35 Piezas: PH 3xPH2 PH3 x 25mm PH1 2xPH2 PH3 x 50mm PZ1 3xPZ2 PZ3 x 25mm PZ1 2xPZ2 PZ3 x 50mm T 15 2xT20 2xT25 T30 x 25mm T15 T20 2xT25 T30 x 50mm SL5.5 x 50mm Llaves de vaso: 6,8,10,13mm Portapuntas magnético 60mm	1	B-66880	0088381540018	40,00

Guía de atornillado Impact Black



Descripción	Unds.	Código	EAN	P.V.P. (€)
Guía de atornillado 80 mm	1	B-66818	0088381539944	5,65

Portapuntas magnético Impact Black



Descripción	Unds.	Código	EAN	P.V.P. (€)
Portapuntas magnético 60 mm	1	B-66793	0088381539920	4,55

Llaves de vaso Impact Black



Descripción	Medidas (mm)	Unds.	Código	EAN	P.V.P. (€)
Llave vaso magnética	6x50	1	B-66824	0088381539951	3,10
Llave vaso magnética	8x50	1	B-66830	0088381539968	3,15
Llave vaso magnética	10x50	1	B-66846	0088381539975	3,10
Llave vaso magnética	13x50	1	B-66852	0088381539982	3,15



**IMPACT
BLACK**

Expositor de cartón Impact Black (10unds)

★★★



Contenido	Pcs.	Unds.	Código	EAN	P.V.P. (€)
Set de puntas	33	10	E-12441-10	0088381587792	227,00

Puntas serie Impact Black

★★★



PH

PZ

T



PH

PZ

T

Descripción	Longitud (mm)	Unds.	Código	EAN	P.V.P. (€)
PH1	25	2	B-63600	0088381532877	1,65
PH2	25	2	B-63616	0088381532884	1,65
PH3	25	2	B-63622	0088381532891	1,65
PH1	50	2	B-63719	0088381532983	2,45
PH2	50	2	B-63725	0088381532990	2,45
PH3	50	2	B-63731	0088381533003	2,45
PZ1	25	2	B-63638	0088381532907	1,65
PZ2	25	2	B-63644	0088381532914	1,65
PZ3	25	2	B-63650	0088381532921	1,65
PZ1	50	2	B-63747	0088381533010	2,45
PZ2	50	2	B-63753	0088381533027	2,45
PZ3	50	2	B-63769	0088381533034	2,45
T15	25	2	B-63666	0088381532938	1,65
T20	25	2	B-63672	0088381532945	1,65
T25	25	2	B-63688	0088381532952	1,65
T30	25	2	B-63694	0088381532969	1,65
T40	25	2	B-63703	0088381532976	1,65

Descripción	Longitud (mm)	Unds.	Código	EAN	P.V.P. (€)
T15	50	2	B-63775	0088381533041	2,45
T20	50	2	B-63781	0088381533058	2,45
T25	50	2	B-63797	0088381533065	2,45
T30	50	2	B-63806	0088381533072	2,45
T40	50	2	B-63812	0088381533089	2,45
PH2	25	25	E-12360	0088381586566	13,65
PH2	50	10	E-12407	0088381586641	9,80
PZ2	25	25	E-12376	0088381586580	13,65
PZ2	50	10	E-12413	0088381586719	9,80
T20	25	25	E-12382	0088381586603	13,65
T25	25	25	E-12398	0088381586627	13,65
T30	25	25	E-12653	0088381588324	13,65
T40	25	25	E-12669	0088381588348	13,65
T20	50	10	E-12429	0088381586665	9,80
T25	50	10	E-12435	0088381586689	9,80
T30	50	10	E-12675	0088381588362	9,80
T40	50	10	E-12681	0088381588386	9,80





Set autoalimentado atornillado

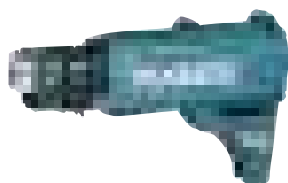

- Convierte tu atornillador de tabiquería seca en uno autoalimentado.
- Para colocación de ristas de tornillo estándar.

Tornillos	Modelos	Código	EAN	P.V.P. (€)
25-55 mm	DFS250 - DFS451 - DFS452 FS2300 FS4000 - FS6300R	191L24-0	0088381566414	95,00



Punta PH2 130mm (5 Unds.) para 199146-8	199155-7	0088381528184	44,00
--	----------	---------------	-------

Puntas para atornilladores autoalimentados



Tipo	Long. (mm)	Modelos	Unds.	Código	EAN	P.V.P. (€)	
PH	PH2	110	6830	1	P-13552	0088381922517	3,70
	PH2	117	DFR440	3	P-66793	0088381997324	12,35
	PH2	127	6832 6833 6835D	1	P-13568	0088381922524	5,90
	PH2	141	6834	1	P-21593	0088381948722	4,65
	PH2	157	6842 DFR550	3	P-67795	0088381998321	16,50
	PH2	177	6844	3	P-67804	0088381998338	19,55
PZ	PZ2	110	6830	1	P-13574	0088381922531	3,60
	PZ2	117	DFR440	3	P-66824	0088381997355	12,35
	PZ2	127	6832 6833 6835D	1	P-13580	0088381922548	5,65
	PZ2	141	6834	1	P-21618	0088381948746	20,10
	PZ2	157	6842 DFR550	3	P-67773	0088381998307	16,50
	PZ2	177	6844	3	P-67789	0088381998314	19,55

Punta magnética para pladur

★★★



Tipo	Longitud (mm)	Unds.	Código	EAN	P.V.P. (€)	
PH	PH2	30	1	D-61690	0088381477949	1,95

Puntas

★★★★★



- Puntas de gran durabilidad para aplicaciones profesionales e industriales.

Tipo	Longitud (mm)	Unds.	Código	EAN	P.V.P. (€)	
PH	PH1	25	10	P-06030	0088381946773	8,25
	PH2	25	10	P-06052	0088381946797	8,25
	PH3	25	10	P-06074	0088381946810	8,25
	PH2	25	3	798312-0	0088381107846	2,05
	PH1	50	10	P-06046	0088381946780	24,00
	PH2	50	10	P-06068	0088381946803	23,00
PZ	PH3	50	10	P-06080	0088381946827	23,00
	PZ1	25	10	P-06096	0088381944328	8,25
	PZ2	25	10	P-06111	0088381944335	8,25
	PZ3	25	10	P-06133	0088381944342	8,25
	PZ1	50	10	P-06105	0088381946834	23,00
	PZ2	50	10	P-06127	0088381944571	23,00
Plana	PZ3	50	10	P-06149	0088381944588	23,00
	LS0,6 X 4,5	25	10	P-06177	0088381946865	13,40
	LS0,8 X 5,5	25	10	P-06199	0088381946889	13,40
	LS1,0 X 5,5	25	10	P-06214	0088381946902	13,40
Hex.	LS1,2 X 8,0	25	10	P-06242	0088381946933	14,40
	3,0 mm.	25	10	P-21375	0088381948524	21,00
	4,0 mm.	25	10	P-21381	0088381948531	21,00
	5,0 mm.	25	10	P-21397	0088381948548	21,00
	6,0 mm.	25	10	P-21406	0088381948555	21,00
	8,0 mm.	25	10	P-21412	0088381948562	28,00
T	T10	25	10	P-06323	0088381947015	13,40
	T15	25	10	P-06339	0088381947022	13,40
	T20	25	10	P-06345	0088381947039	13,40
	T25	25	10	P-06351	0088381947046	13,40
	T27	25	10	P-06367	0088381947053	13,40
	T30	25	10	P-06373	0088381947060	13,40
	T40	25	10	P-06389	0088381947077	13,40

Portapuntas

Rapidfix

★★★★

- Sujeción segura y sin holgura del portapuntas.
- El mecanismo de sujeción especial de este portapuntas permite retener todo tipo de puntas con acople hexagonal de 1/4".
- Manejo con una mano, para un cambio rápido de la punta.
- Estilizado cuerpo de metal con casquillo funcional ergonómico. Aguanta las más duras condiciones de atornillado y taladrado.
- Recomendado para atornilladores de impacto.



Tipo	Long. (mm)	Inserción	Unds.	Código	EAN	P.V.P. (€)
Click	60	1/4"	1	P-54075	0088381984584	18,00

Clickfix

★★★★

- Magnético.
- Robusto cuerpo en aluminio.
- Sujeción segura de las puntas o brocas.
- Manejo con una sola mano.
- Casquillo de guía giratorio para un atornillado más fácil y seguro.



Tipo	Long. (mm)	Inserción	Unds.	Código	EAN	P.V.P. (€)
Imantado	60	1/4"	1	P-53263	0088381983778	17,50

Porta puntas 80mm para SDS-PLUS

★★★



Longitud (mm)	Inserción	Unds.	Código	EAN	P.V.P. (€)
80	SDS - PLUS	1	B-57548	0088381519151	6,20

Estándar

★★

- Magnético.
- Robusto cuerpo metálico.
- Sujeción segura de las puntas.



Tipo	Long. (mm)	Inserción	Unds.	Código	EAN	P.V.P. (€)
Imantado	60	1/4"	1	784811-8	0088381430807	3,75
	75	1/4"	1	784801-1	0088381114738	3,20

Portapuntas flexible

★★★★

- Portapuntas magnético.
- Ideales para realizar atornillados en esquinas o bordes de difícil acceso.
- El eje se puede doblar para conseguir llegar a lugares estrechos donde es complicado el atornillado.



Tipo	Long. (mm)	Inserción	Unds.	Código	EAN	P.V.P. (€)
Magnético	200	1/4"	1	B-29072	0088381415507	6,80
Magnético	300	1/4"	1	B-29094	0088381415521	8,50

- Especial impacto.

★★★★★



Tipo	Long. (mm)	Inserción	Unds.	Código	EAN	P.V.P. (€)
Magnético	300	1/4"	1	B-51867	0088381466806	34,00



Vasos especiales colocación en varilla roscada

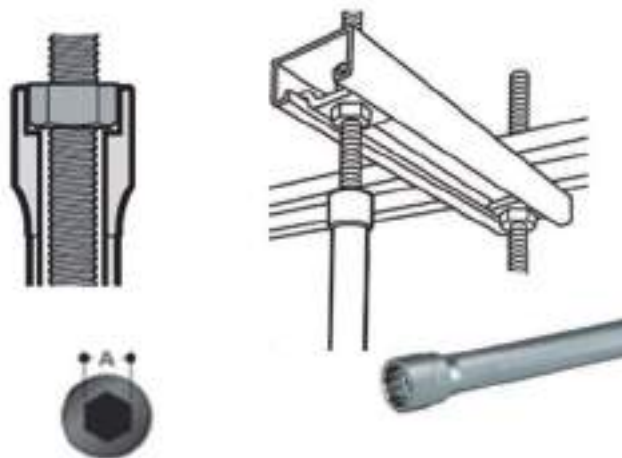

Ø (mm)	Long. (mm)	Inserción	Unds.	Código	EAN	P.V.P. (€)
10	150	1/4"	1	B-52532	0088381469111	25,00
10	300	1/4"	1	B-52548	0088381469128	27,00
10	500	1/4"	1	B-52554	0088381469135	46,00
13	150	1/4"	1	B-52582	0088381469166	25,00
13	300	1/4"	1	B-52598	0088381469173	27,00
13	500	1/4"	1	B-52607	0088381469180	46,00
17	150	1/4"	1	B-52635	0088381469210	27,00
17	300	1/4"	1	B-52641	0088381469227	30,00
17	500	1/4"	1	B-52657	0088381469234	48,00

Llaves de vaso 1/4" hex. desmontables

Llave de vaso imantada desmontable para una fácil limpieza.

Quitando el vaso queda al descubierto el vástago con las virutas recogidas. De esta forma podemos limpiarlo con un cepillo o un papel.

Con otras llaves de vaso las virutas quedan retenidas en el imán. Al no poder desmontarlo hace que el trabajo sea más complicado y la duración menor.

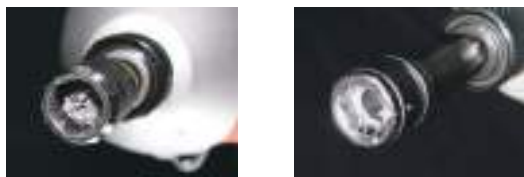

- Larga duración, hasta 20 veces más que otras marcas. Cada componente está fabricado en el material más óptimo para proporcionar una mejor resistencia a la rotura.
- Imán de neodimio para una fijación extra fuerte.
- Longitud total de 61mm (contando con el vaso).
- Se presenta en blíster de vástago + vaso.

Tornillo	Ø (mm)	Longitud (mm)	Unds.	Código	EAN	P.V.P. (€)
M5	8	61	1	B-40266	0088381437370	9,80
3/8"	9,6	61	1	B-40272	0088381437387	10,05
M6	10	61	1	B-40288	0088381437394	10,30

Llaves de vaso 1/4" magnéticos



Tornillo	Ø (mm)	Longitud (mm)	Unds.	Código	EAN	P.V.P. (€)
M3	5,5	50	1	B-38685	0088381433327	2,25
M3,5	6	50	1	B-38691	0088381433334	2,25
M4	7	50	1	B-38700	0088381433341	4,50
M5	8	50	1	B-38716	0088381433358	2,30
M6	10	50	1	B-38722	0088381433365	2,25
M8	12	50	1	B-38738	0088381433372	2,30
M8	13	50	1	B-38744	0088381433389	4,55
M10	17	50	1	B-38750	0088381433396	4,55
Para modelo FS2500 y FS2700						
M6	10	65	1	784806-1	008838114585	21,00
1/2"	12,7	65	1	784805-3	0088381102735	22,00



Llaves de vaso para colocación de varilla roscada

★★★★★



Ø (mm)	Inserción	Unds.	Código	EAN	P.V.P. (€)
6	1/4"	1	B-42961	0088381441995	18,00
8	1/4"	1	B-42977	0088381442008	18,55
10	1/4"	1	B-42983	0088381442015	19,05

Adaptador cambio de inserción

★★



Descripción	Unds.	Código	EAN	P.V.P. (€)
Adaptador 1/4 a 3/8"50mm.	1	B-54667	0088381478380	2,70
Adaptador 1/4 a 1/2"50mm.	1	B-54673	0088381478397	3,55
Adaptador 1/4 a 3/8"150mm.	1	B-57738	0088381521994	8,70
Adaptador 1/4 a 1/2"150mm.	1	B-57744	0088381522007	10,65

Set de llaves de vaso para HR166

★★



Tamaño (mm)	Longitud (mm)	Unds.	Código	EAN	P.V.P. (€)
8 - 10 - 12 - 13	48	1	B-57554	0088381519168	6,25

Kit de ensamblaje rápido

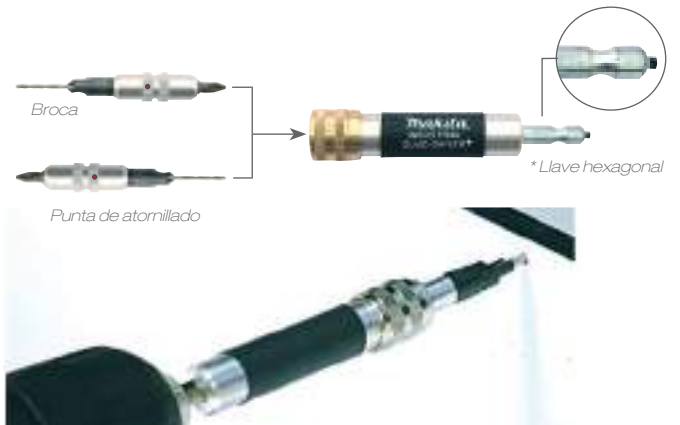

Ø (mm)	Tipo	Unds.	Código	EAN	P.V.P. (€)
8	.	1	P-44074	0088381974271	11,85
10	Industrial*	1	784830-A	0088381925419	15,95

Guía de atornillado

★★



Contenido	Longitud (mm)	Unds.	Código	EAN	P.V.P. (€)
Guía 80 mm	80	1	B-48751	0088381455756	4,80
Guía 120 mm	120	1	B-52934	0088381471312	5,40
Guía 120 mm	120	1	B-48767	0088381455763	5,95
Guía 80 mm 5 Ph2 5 Pz2 5 T20 5 T25 5 T30	80	1	B-48773	0088381455770	16,35
Guía 120 mm 5 Ph2 5 Pz2 5 T20 5 T25 5 T30	120	1	B-48789	0088381455787	16,35

Estuche de puntas (7 pcs)



★★

- Puntas 25mm: PH1, PH2, SL3, SL5, PZ2 y PZ3.
- Compacta e ideal para transportarla.
- Contenido visible gracias a la cubierta transparente.
- Portapuntas magnético.

Contenido	Unds.	Tipo	Código	EAN	P.V.P. (€)
7	1	**	D-73271	0088381582391	4,15

Bote de puntas imantadas a granel

- 100 Puntas dobles imantadas.
- Disponibles en el tipo PH n°2 y en PZ n°2.
- Inserción de 1/4" hexagonal válida para atornilladores de impacto y taladros atornilladores.
- Puntas dobles de 65mm de largo.

★★★



Longitud (mm)	Tipo	Unds.	Código	EAN	P.V.P. (€)
65	Doble PH2	1	D-31669	0088381356503	50,00
65	Doble PZ2	1	D-34914	0088381367080	50,00

Bote de puntas a granel

★★

- Disponibles en el tipo PH n°2 y en PZ n°2 de 25mm y 50mm.
- Puntas imantadas de 25mm de largo.



Longitud (mm)	Tipo	Unds.	Código	EAN	P.V.P. (€)
25	PH2	1	B-24876	0088381409193	27,00
25	PZ2	1	B-24882	0088381409209	27,00
50	PH2	1	B-26490	0088381410229	26,00
50	PZ2	1	B-26509	0088381410236	26,00

Estuches de puntas

★★



Punta	Unds.	Código	EAN	P.V.P. (€)
31 piezas por estuche: 1xPH0, 1xPH1, 4xPH2, 1xPH3 1xPZ0 1xPZ1, 4xPZ2, 1xPZ3 1xT10, 1xT15, 2xT20, 2xT25, 1xT27, 1xT30, 1xT40 1xH3, 1xH4, 1xH5, 1xH6 Planas: 4,5 / 5,5 / 6,5 Portapuntas magnético	12	E-00022	0088381553155	220,00



★★

Punta	Unds.	Código	EAN	P.V.P. (€)
31 Piezas: 2xPh1, 4xPh2, 1xPh3 2xPz1, 5xPz2, 1xPz3 2xT10, 2xT15, 2xT20 3xT25, 2xT30, 1xT40 4 5,5 6,5mm Portapuntas magnético	1	D-30667	0088381354295	11,35

Puntas dobles imantadas

★★★

- Pack con diez puntas dobles con dispensador.
- 10 puntas dobles imantadas.
- Inserción de 1/4" hexagonal válida para atornilladores de impacto y taladros atornilladores.
- Punta doble de 65mm de largo.



Medida (mm)	Tipo de punta	Unds.	Código	EAN	P.V.P. (€)
65	Doble PH2	1	D-34366	0088381365550	9,20

Estuche de puntas (11 pcs).

★★

- Portapuntas magnético.
- Punta PH2.
- Puntas PZ: PZ1, PZ2 y PZ3.
- Puntas T: T10, T15, T20, T25, T30 y T40.



Medida (mm)	Contenido	Unds.	Código	EAN	P.V.P. (€)
25	11 piezas	1	D-64995	0088381533782	9,75

Estuche de puntas y vasos

★★★

- Puntas PZ: PZ1x2, PZ2x2, PZ3x2.
- Puntas PH: PH1x2, PH2x2, PH3x2.
- Puntas hexagonales: H2, H2.5, H3, H4x2, H5x2, H6x2.
- Puntas planas: SL4.5x2, SL5.5x2, SL6.5x2.
- Puntas T: T10x2, T15x2, T20x2, T25x2, T30x2, T40
- Llaves de vaso: Hex5, Hex6, Hex7, Hex8 Hex9, Hex10, Hex10, Hex11.
- Portapuntas magnético.
- Destornillador manual con carraca.



Contenido	Unds.	Código	EAN	P.V.P. (€)
47 piezas	1	B-36170	0088381433549	31,00

Estuche de puntas y llave de carraca

★★★

- Puntas PZ1, PZ2.
- Puntas PH1, PH2, PH3.
- Puntas hexagonales H4, H6.
- Puntas planas SL0,8x5.5, SL1,2x6.5.
- Puntas T T20, T25, T30.
- Llaves de vaso Hex5, Hex6, Hex8, Hex10, Hex12, Hex13.
- Punta 1/4"Hex.
- Portapuntas magnético
- Carraca.



Contenido	Unds.	Código	EAN	P.V.P. (€)
21 piezas	1	B-54081	0088381476966	34,00

Destornilladores de golpe

- Ideal para tornillos fuertemente apretados que no se pueden desatornillar con herramientas eléctricas o que son muy complicados de liberar con un destornillador manual.
- Aprovecha la fuerza del impacto para generar una fuerza contraria que termina por desatornillar el tornillo. Dispone de un muelle en el interior que al recibir el golpe del martillo, se comprime y libera dicha fuerza en forma de giro.



Punta	Longitud (mm)	Unds.	Código	EAN	P.V.P. (€)
PH2	125	1	B-42438	0088381440226	19,05
PZ2	125	1	B-42450	0088381440240	19,05

Estuche de puntas

★★

- Puntas PZ PZ0, PZ1, PZ2x2, PZ3.
- Puntas PH PH0, PH1, PH2x2, PH3.
- Puntas hexagonales H3, H4, H5, H6.
- Puntas planas SL4, SL4.5, SL5.5, SL6.5
- Puntas T T10, T15, T20x2, T25x2, T27, T30x2, T40
- Puntas T de seguridad T10H, T15H, T20H, T25H, T27H, T30H, T40H.
- Portapuntas magnético.



Contenido	Unds.	Código	EAN	P.V.P. (€)
37 piezas	1	B-28606	0088381414807	22,00

Estuche de puntas y vasos (30 pcs)

- Puntas 25 mm PH, PZ, T, Hex y planas. ★★
- Puntas 50 mm PH, PZ, T y planas.
- Portapuntas magnético.
- Adaptador para vasos 3/8".
- Vasos 3/8" 63 mm: 17 y 19 mm.
- Vasos 1/4" hex. magnéticos 8 y 10 mm.



Contenido	Unds	Código	EAN	P.V.P. (€)
30 piezas	1	E-07060	0088381571265	31,00

Set de llaves, puntas y vasos 221pcs

- Llave de carraca 1/4" y 1/2". ★★★
- Llave manual 1/4".
- Extensiones para vasos 1/4" y para vasos 1/2".
- Adaptador 3 posiciones de 1/2" a 3/8".
- Rótulas de 1/4" y 1/2".
- Vasos 1/4" de 25 mm: 4, 4.5, 5, 5.5, 6, 7, 8, 9, 10, 11, 12, 13 y 14.
- Vasos 1/2" de 38 mm: 15, 16, 17, 19, 20, 21, 22, 24, 27, 30 y 32.
- Vasos estrella 1/2" de 38 mm: E10, E12, E14, E16, E18, E20 y E24.
- Vasos 1/4" hex. de 38 mm: 5, 5.5, 6, 7, 8, 9, 10, 11, 12 y 13.
- Llaves fijas combinadas de 8 a 19 mm.
- Set de llaves allen de 1.5 a 8 mm.
- Mango destornillador.
- Puntas planas, PH, PZ, T, Hex...
- Portapuntas magnético.



Contenido	Unds	Código	EAN	P.V.P. (€)
221 piezas	1	E-10883	0088381581486	201,00

Maletín de herramienta manual 120 piezas

- Llave de carraca 3/8".
- Vasos 1/4" 25mm: 4, 4.5, 5, 5.5, 6, 7, 8, 9, 10, 11, 12, 13 y 14mm.
- Vasos 3/8" 28 y 30mm: 8, 9, 10, 11, 12, 13, 14, 15, 16, 17, 18, 19, 20 y 21mm.
- Vasos estrella 1/4" 25mm: E4, E5, E6, E7 y E8.
- Vasos estrella 3/8" 28 y 30mm: E10, E11, E12, E14, E16 y E18.
- Vasos largos 1/2" de 16 y 21mm.
- Adaptadores 3/8", 1/4" y 1/2".
- Extensiones para vasos 1/4" y para vasos 3/8".
- Rótulas de 1/4" y 3/8".
- Llaves fijas combinadas de 8, 10, 11, 12, 13, 14 y 15mm.
- Llave manual 1/4".
- Portapuntas magnético y guía de atornillado.
- Puntas planas, PH, PZ, T, Hex...



Contenido	Unds	Código	EAN	P.V.P. (€)
120 piezas	1	E-06616	0088381570251	129,00



Maletín de herramienta manual (120 pcs)

- Llave de carraca 3/8".
- Destornillador manual 1/4".
- Vasos 3/8": 8 - 9 - 10 - 11 - 12 - 13 - 14 - 15 - 16 - 17 - 18 - 19 - 20 - 21 mm.
- Vasos 1/4": 4 - 4,5 - 5 - 5,5 - 6 - 7 - 8 - 9 - 10 - 11 - 12 - 13 - 14 mm.
- Vasos 1/4": E4 - E5 - E6 - E7 - E8. Vasos 3/8": E10 - E11 - E12 - E14 - E16 - E18.
- Adaptador de 3/8" a 1/2" y dos vasos largos de 16 y 21 mm.
- Extensiones 3/8" de 75 y 150 mm.
- Extensiones 1/4" de 50 y 100 mm.
- Adaptadores móviles de 3/8" y 1/4".
- Portapuntas y portapuntas magnético.
- Puntas PH, PZ, T, TH, HH y planas.
- Llaves manuales 8 - 10 - 11 - 12 - 13 - 14 - 15 mm.
- Juego de llaves allen 1,5 - 2 - 2,5 - 3 - 4 - 5 - 6 - 8 mm.

★★★★



Contenido	Unds	Código	EAN	P.V.P. (€)
120 piezas	1	E-08713	0088381576727	140,00



Maletín herramienta manual (87 pcs)

- Llave de carraca 1/2" 250 mm.
- Llave de carraca doble 1/4" y 3/8" 140 mm.
- Llave manual 1/4" 152 mm.
- Llave ajustable 150 mm.
- Alicates 175 mm.
- Vasos largos 1/2" 78 mm: 8, 10, 12, 13, 15, 17 y 19 mm.
- Vasos largos 1/2" 65 mm: 16, 18 y 21 mm.
- Vasos 1/4" 25 mm: 5, 6, 7, 8, 9, 10, 11, 12 y 13 mm.
- Adaptador 1/4" hex.
- Portapuntas 1/4" hex. 60 mm.
- Portapuntas magnético 1/4" hex. 60 mm.
- Set llaves allen 1.5, 2, 2.5, 3, 4, 5, 6 y 8 mm.
- Adaptador 1/2" a 3/8".
- Adaptador 1/4" a 1/4" hex.
- Llaves fijas combinadas: 10, 12, 13, 14 y 17 mm.
- Destornilladores PZ2, SL1.0, PH1 y PH2.
- Destornillador para carburador 115 mm.
- Puntas PH: PH1, PH2 y PH3.
- Puntas PZ: PZ1, PZ2 y PZ3.
- Puntas planas: SL0.5x3.0, SL0.8 x 4.0 y SL0.8 x 5.0.
- Puntas T: T9, T10, T15, T20, T25, T27, T30, T35 y T40.
- Puntas TH: T10H, T15 H, T20H, T25H, T27H, T30H, T35H y T40H.
- Puntas hex.: HEX3, HEX4, HEX5 y HEX6.

★★★★



Contenido	Unds	Código	EAN	P.V.P. (€)
87 piezas	1	E-11542	0088381583466	162,00

Set herramientas manuales (87 pcs)

★★★

- Llave de carraca 1/2".
- Llave de carraca con doble inserción 1/4" y 3/8".
- Llave portapuntas manual 152 mm.
- Llave manual ajustable 150 mm.
- Alicates 150 mm.
- Llaves combinadas manuales 10 - 12 - 13 - 14 - 17 mm.
- Set de llaves allen 1,5 - 2 - 2,5 - 3 - 4 - 5 - 6 - 8 mm.
- Destornilladores manuales PH1, PH2, PZ2 y plano 1.0 - 6.0.
- Desatornillador para carburadores.
- Vasos 1/4": 5 - 6 - 7 - 8 - 9 - 10 - 11 - 12 - 13 mm.
- Vasos largos 1/2": 8 - 10 - 12 - 13 - 15 - 17 - 19 mm.
- Portapuntas y portapuntas magnético.
- Puntas PH, PZ, T y TH.
- Adaptador 1/4".



Set herramientas manuales (76 pcs)

★★★

- Llave de carraca 3/8"
- Destornillador para puntas 1/4
- Cúter
- Desatornillador para vasos 1/4"
- Martillo 180mm
- Alicates 150 mm.
- Alicates de punta de aguja 150mm
- Vasos largos 3/8": 8mm - 9mm - 10mm - 11mm - 12mm - 13mm - 14mm - 15mm - 16mm - 17mm - 18mm - 19mm - 20mm - 21mm
- Vasos 1/4": 4 - 5 - 6 - 7 - 8
- Portapuntas magnético.
- Set de llaves de vaso 1/4": 5 - 6 - 7 - 8 - 9 - 10 - 11
- Adaptador de vaso 1/2" 1/4" - 3/8"
- Puntas 25mm 1/4": PH1 - PH2 - PH3 - T8 - T9 - T10 - T15 - T20 - T25 - T27 - T30 - T40 - T8H - T10H - T15H - T20H - T25H - T27H - T30H - T40H - SL 0,5X3,0 - SL 0,8X4,0 - SL 0,8X5,0 - SL 1,0X5,5 - SL 1,0X6,0
- Extensores para vasos 3/8" 75mm 150mm
- Rótulas 1/4" y 3/8".



Contenido	Unds	Código	EAN	P.V.P. (€)
87 piezas	1	E-08458	0088381575638	152,00

Contenido	Unds	Código	EAN	P.V.P. (€)
76 piezas	1	E-10899	0088381581493	102,00



Vasos para llaves de impacto



*No incluye bulón ni arandela goma.



Inserción	Métrica	Ø int (mm)	Ø ext (mm)	Long. (mm)	Código	EAN	P.V.P. (€)
3/8"	-	6	11	28	B-39883	0088381436595	3,55
3/8"	-	7	12	28	B-39899	0088381436601	3,55
3/8"	-	8	13	28	B-39908	0088381436618	3,55
3/8"	-	9	14	28	B-39914	0088381436625	3,55
3/8"	-	10	15	28	B-39920	0088381436632	3,55
3/8"	-	11	18	28	B-39936	0088381436649	3,55
3/8"	M7	12	18	28	B-39942	0088381436656	3,50
3/8"	M8	13	20	28	B-39958	0088381436663	4,10
3/8"	M8	14	20	28	B-39964	0088381436670	4,10
3/8"	-	15	22	28	B-39970	0088381436687	4,35
3/8"	-	16	24	28	B-39986	0088381436694	4,35
3/8"	M10	17	24	28	B-39992	0088381436700	4,35
3/8"	-	18	28	28	B-40004	0088381436717	4,90

Tipo	Inserción	Métrica	Ø int (mm)	Ø ext (mm)	Long. (mm)	Código	EAN	P.V.P. (€)	
D	3	3/4"	M10	17	28	50	A-85494	0088381158817	9,80
E	4	3/4"	M10	17	31	95	A-85503	0088381158824	19,55
D	3	3/4"	M12	19	30	50	A-85519	0088381158831	10,30
E	4	3/4"	M12	19	33	95	A-85525	0088381158848	19,55
D	3	3/4"	M14	21	32	52	A-85531	0088381158855	10,30
E	4	3/4"	M14	21	35	95	A-85547	0088381158862	19,55
D	3	3/4"	M14	22	34	52	A-85553	0088381158879	10,30
E	4	3/4"	M14	22	37	95	A-85569	0088381158886	19,55
D	3	3/4"	M16	24	36	52	A-85575	0088381158893	10,30
E	4	3/4"	M16	24	39	95	A-85581	0088381158909	18,55
D	3	3/4"	M16	26	38	52	134853-6	0088381149105	11,35
E	4	3/4"	M16	26	44	95	134854-4	0088381149112	23,00
D	3	3/4"	M18	27	38	52	134855-2	0088381149129	10,30
E	4	3/4"	M18	27	44	95	134856-0	0088381149136	21,00
		3/4"	M20	30	44	52	134857-8	0088381149143	10,30
		3/4"	M20	30	44	95	134858-6	0088381149150	18,00
F	5	3/4"	M22	32	44	52	134871-4	0088381149167	10,30
		3/4"	M22	32	44	95	134859-4	0088381149174	18,55
		3/4"	M22	35	44	56	134860-9	0088381149181	13,40
		3/4"	M22	35	44	95	134861-7	0088381149198	25,00
		3/4"	M24	36	44	56	134862-5	0088381149204	14,95
		3/4"	M24	36	44	95	134863-3	0088381149211	22,00

Tipo	Inserción	Métrica	Ø int (mm)	Ø ext (mm)	Long. (mm)	Código	EAN	P.V.P. (€)	
A	1	1/2"	M7	12	19	38	A-89931	0088381185882	4,10
		1/2"	M7	12	25	75	134867-5	0088381152488	33,00
		1/2"	M8	13	25	38	134825-1	0088381148948	4,90
		1/2"	M8	13	26	52	134827-7	0088381148955	6,45
		1/2"	M8	14	25	38	134826-9	0088381160704	4,90
		1/2"	M8	14	25	52	134828-5	0088381170178	5,15
		1/2"	-	16	25	38	B-10506	0088381343299	4,90
		1/2"	M10	17	26	38	134829-3	0088381148962	4,90
		1/2"	M10	17	26	52	134830-8	0088381148979	4,90
		B	1	1/2"	M12	19	28	38	134831-6
1/2"	M12			19	28	52	134832-4	0088381148993	5,65
C	1	1/2"	M12	19	30	78	134837-4	0088381161824	8,00
		1/2"	M14	21	30	38	134838-2	0088381161787	6,20
B	1	1/2"	M14	21	28	52	134833-2	0088381161794	7,20
C	1	1/2"	M14	21	30	78	134839-0	0088381161831	8,75
B	1	1/2"	M14	22	30	38	134851-0	0088381149006	6,45
C	1	1/2"	M14	22	28	52	134834-0	0088381149013	7,20
C	1	1/2"	M14	23	30	38	134840-5	0088381161800	6,45
B	2	1/2"	M14	23	28	52	134835-8	0088381170499	7,70
C	2	1/2"	M16	24	30	45	134841-3	0088381149020	7,70
B	2	1/2"	M16	24	28	52	134836-6	0088381149037	8,00
C	2	1/2"	M16	26	30	50	134842-1	0088381161770	8,50
		1/2"	M16	26	30	75	134843-9	0088381161817	10,80
		1/2"	M18	27	30	50	134844-7	0088381149044	7,70
		1/2"	M18	27	30	78	134845-5	0088381149051	11,85
		1/2"	M20	30	30	50	134846-3	0088381149068	9,25
		1/2"	M20	30	30	78	134847-1	0088381149075	12,35
		1/2"	M22	32	30	50	134848-9	0088381149082	9,00
		1/2"	M22	32	30	78	134849-7	0088381149099	12,90

Tipo	Inserción	Métrica	Ø int (mm)	Ø ext (mm)	Long. (mm)	Código	EAN	P.V.P. (€)	
F	5	1"	M22	35	52	80	134864-1	0088381200882	23,00
		1"	M24	36	52	80	134865-9	0088381200899	22,00
		1"	M27	41	52	80	134872-2	0088381200011	24,00

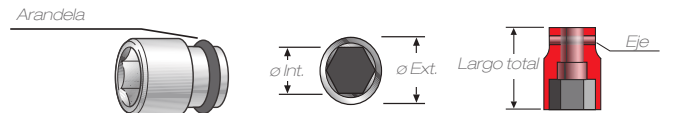

Arandela de goma - Bulón



Tipo	Código	EAN	P.V.P. (€)	Tipo	Código	EAN	P.V.P. (€)
A	213397-0	-	1,00	1	268056-1	-	1,00
B	213398-8	0088381155496	1,00	2	268057-9	0088381162708	1,00
C	213399-6	0088381495240	1,00	3	256283-2	-	1,00
D	213461-7	3240890114174	1,00	4	256282-4	0088381495431	1,00
E	213514-2	0088381495264	1,00	5	256284-0	0088381200035	1,90
F	213570-2	0088381200028	1,00				

Estuche de llaves de vaso 9 piezas

- Estuche de 9 piezas con espuma interior para una buena conservación de los vasos.
- Práctico estuche de plástico con cierre y logo Makita.
- Cada vaso monta su propia goma y bulón, para una sujeción perfecta a la máquina.
- Estos vasos están diseñados especialmente para trabajar con herramientas eléctricas o de aire.
- Información de la composición: CR-MO (Cromo - molibdeno)
- CR-MO: para herramientas eléctricas



★★★

Inserción	Ø int. (mm)	Ø ext. (mm)	Long. (mm)	Código	EAN	P.V.P. (€)
1/2"	8	15	38	D-41517	0088381404334	54,00
1/2"	10	17,5	38			
1/2"	13	20	38			
1/2"	16	24	38			
1/2"	17	26	38			
1/2"	18	28	38			
1/2"	19	28	38			
1/2"	21	30	38			
1/2"	24	34	38			

Juego de llaves de vaso para automóvil

★★★



Inserción	Ø int. (mm)	Ø ext. (mm)	Long. (mm)	Código	EAN	P.V.P. (€)
1/2"	3	17	86	E-12354	0088381586528	31,00
1/2"		19				
1/2"		21				

Adaptadores de inserción para DWR100D



Modelos	Unds.	Código	EAN	P.V.P. (€)
Para vasos 3/8"	1	191A50-3	0088381546744	20,10
Para vasos 1/4"	1	191A51-1	0088381546737	20,10

Tope de profundidad para atornilladores de impacto



Modelos	Unds.	Código	EAN	P.V.P. (€)
TD0101F DTD145 DTD146	1	194281-7	0088381276108	28,00

Accesorios para DTL061



134745-9

192439-2

192440-7

Descripción	Unds.	Código	EAN	P.V.P. (€)
Adaptador de 3/8"	1	134745-9	0088381134361	19,00
Adaptador 1/2"	1	134746-7	0088381142632	18,55
Cabezal de carraca	1	192439-2	0088381128742	154,00
Cabezal recto	1	192440-7	0088381128759	69,00

Extensión



Inserción	Longitud (mm)	Unds.	Código	EAN	P.V.P. (€)
1/2"	100	1	134874-8	0088381149228	23,00
3/4"	150	1	134997-2	0088381194730	49,00
1"	200	1	134870-6	0088381150200	67,00

Rótula



Inserción	Longitud (mm)	Unds.	Código	EAN	P.V.P. (€)
1/2"	80	1	134877-2	0088381149242	66,00
3/4"	105,5	1	134998-0	0088381206891	100,00

Cambios de inserción



P-05941



P-05963



B-68448

Inserción	Salida	Longitud (mm)	Unds.	Código	EAN	P.V.P. (€)
1/2"	1/4"	47	1	P-05941	0088381946681	43,00
3/8"	1/4"	37	1	P-05963	0088381946704	37,00
1/2"	1/4"	47	1	B-68448	0088381546287	16,20

★★★★

★★★★

★★★

Gancho para cinturón



Modelos	Unds.	Código	EAN	P.V.P. (€)
DTD154 DTD170 DTD171	1	197043-2	0088381447362	30,00

Mango de extensión



Modelo	Longitud (mm)	Unds.	Código	EAN	P.V.P. (€)
6844 6842 DFR440 DFR550	890 - 990	1	194500-1	0088381342377	83,00

Mango de extensión



Modelo	Medidas (mm)	Unds.	Código	EAN	P.V.P. (€)
DTW1001 DTW1002 DTW700 DTW701 TW001G	807 - 657x243x172 mm	1	191G67-2	0088381568302	129,00

Portabrocas automático - 1/4" hexagonal



763198-1



784643-3

Inserción	Capacidad (mm)	Paso	Tipo	Código	EAN	P.V.P. (€)
1/4"hex	1,0 - 10	3/8"	Automático	763198-1	0088381256070	26,00
Adaptador	1/2"	3/8"	-	784643-3	0088381248013	4,65

Cable conector



Modelos	Long. (mm)	Calidad	Unds.	Código	EAN	P.V.P. (€)
FS6300R	4	Standard	1	699020-5	3240890265913	12,55
	10	Standard	1	194330-0	0088381289863	24,00
	10	Alta	1	194906-3	0088381354066	37,00

Anillo cierre para bocas de atornillado*



*necesario para todas las bocas de atornillado, excepto vasos para FS2700

Unds.	Código	EAN	P.V.P. (€)
1	455591-0	-	1,75

Empuñadura auxiliar



Modelo	Longitud (mm)	Unds.	Código	EAN	P.V.P. (€)
6906	110	1	122464-9	0088381152495	17,50
TW1000	110	1	122727-3	0088381199988	21,00

Bocas atornillado



Modelos	Para	Medida	Unds.	Código	EAN	P.V.P. (€)
FS2500	Vaso	1/4"	1	450963-4	0088381365093	1,80
		5/16"	1	450967-6	0088381468633	1,20
		3/8"	1	450968-4	0088381365109	1,20
	Punta	60 mm	1	122867-7	3240890367600	6,10
		75 mm	1	122868-5	-	6,75
FS2300 FS4200 FS6300R	Punta	60 mm	1	158875-2	3240890322227	6,70
		75 mm	1	158876-0	0088381468558	7,25
FS2700	Puntas 50 mm	-	1	322120-3	0088381162753	8,00
		1/4"	1	322124-5	3240890027573	12,35
	Vaso	5/16"	1	322125-3	-	12,90
		3/8"	1	322119-8	3240890083586	18,55
		7/16"	1	322126-1	-	13,90



Limpiar y Cepillar



Gratas para taladros



Makita

Gratas

Material



Alambre de acero ondulado

- Recomendado para la eliminación del óxido, barnices, esmaltes... de superficies metálicas.



Nylon grueso

- Perfecto para la limpieza de óxido, barnices, esmaltes... de superficies de metal, madera y PVC.



Nylon fino

- Para un acabado más suave.
- Válido para madera, metal y PVC.

Forma



Cepillos de acabado

- Perfecto para superficies estrechas o de difícil acceso.



Copa ondulada

- Ideal para la limpieza de superficies planas o rugosas.

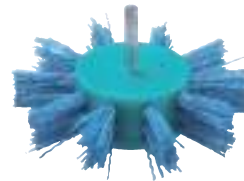

Cepillos de púas

- Para superficies planas.
- Recomendado para la madera.



Cepillo oblicuo

- Idóneo para la limpieza de superficies estrechas, bordes o ranuras.



Alambre trenzado



Alambre



Alambre latonado



Nylon grueso G80



Nylon fino G240

	Alambre trenzado	Alambre	Alambre latonado	Nylon grueso G80	Nylon fino G240
Indicado para	Ideal para metal y trabajos pesados	Ideal para metal y trabajos suaves	Ideal para metal y madera. Alambre resistente a la oxidación.	Ideal para el óxido ligero de metal, madera y PVC.	Ideal para el acabado de materiales, madera y PVC.
Eficiencia	Muy alta eficiencia	Alta eficiencia	Alta eficiencia	Baja eficiencia	Muy baja eficiencia
Acabado	Muy basto	Basto	Basto	Limpio	Muy limpio
Madera	X	X	✓	✓	✓
PVC	X	X	◆	✓	✓
Metal	✓	✓	✓	✓	✓

✓ : Recomendado ◆ : Válido X : No recomendado

Gratas para taladros

Cepillos de acabado de nylon ★★

- Ideal para superficies estrechas o de difícil acceso. Eliminación de óxido, esmaltes, barnices, etc. Tanto en metales, plásticos o maderas.



Ø (mm)	Inserción (mm)	Grano	Espesor (mm)	Tipo	Unds.	Código	EAN	P.V.P. (€)
12	6	80	1,4	Nylon	1	D-45668	0088381408875	3,00
17	6	80	1,4	Nylon	1	D-45674	0088381408882	3,80
24	6	80	1,4	Nylon	1	D-45680	0088381408899	4,35
30	6	80	1,4	Nylon	1	D-45696	0088381408905	6,00
12	6	240	0,7	Nylon	1	D-45705	0088381408912	3,00
17	6	240	0,7	Nylon	1	D-45711	0088381408929	3,80
24	6	240	0,7	Nylon	1	D-45727	0088381408936	4,35
30	6	240	0,7	Nylon	1	D-45733	0088381408943	6,00

Cepillos de acabado de alambre ★★

- Muy eficaz para superficies estrechas y de difícil acceso. Alambres ondulados para que la superficie terminada quede mucho más suave.



Ø (mm)	Inserción (mm)	Grano	Espesor (mm)	Tipo	Unds.	Código	EAN	P.V.P. (€)
12	6	-	-	Alambre	1	D-40004	0088381400121	1,65
19	6	-	-	Alambre	1	D-40010	0088381400138	1,90
25	6	-	-	Alambre	1	D-40026	0088381400145	2,45
30	6	-	-	Alambre	1	D-40032	0088381400152	2,70

Cepillos de acabado de alambre latonado ★★

- Ideal para trabajar superficies estrechas y de difícil acceso.
- Más blandas, ideal para madera.



D-73710

D-73726

D-73732

Ø (mm)	Inserción (mm)	Grano	Espesor (mm)	Tipo	Unds.	Código	EAN	P.V.P. (€)
12	6	-	-	Latonado	1	D-73704	0088381586238	1,35
19	6	-	-	Latonado	1	D-73710	0088381586245	1,55
24	6	-	-	Latonado	1	D-73726	0088381586252	1,85
28	6	-	-	Latonado	1	D-73732	0088381586269	2,10

Cepillos de acabado de alambre trenzado ★★

- Ideal para superficies estrechas y de difícil acceso. Indicadas para metal.
- Alambre de acero más grueso para trabajos más exigentes.



D-73835

D-73841

D-73863

Ø (mm)	Inserción (mm)	Grano	Espesor (mm)	Tipo	Unds.	Código	EAN	P.V.P. (€)
12	6	-	-	Trenzada	1	D-73835	0088381586467	2,25
19	6	-	-	Trenzada	1	D-73841	0088381586474	2,90
24	6	-	-	Trenzada	1	D-73857	0088381586481	3,40
28	6	-	-	Trenzada	1	D-73863	0088381586498	4,45



Gratas para taladros

Cepillos de copa ondulada de nylon



- Ideal para la limpieza de superficies planas o rugosas. Eliminación de óxido, esmaltes, barnices, etc. Tanto en metales, como en plásticos o maderas.



Ø (mm)	Inserción (mm)	Grano	Espesor (mm)	Tipo	Unds.	Código	EAN	P.V.P. (€)
50	6	80	1,4	Nylon	1	D-45509	0088381408714	4,90
63	6	80	1,4	Nylon	1	D-45515	0088381408721	6,55
75	6	80	1,4	Nylon	1	D-45521	0088381408738	7,60
50	6	240	0,7	Nylon	1	D-45537	0088381408745	4,90
63	6	240	0,7	Nylon	1	D-45543	0088381408752	6,55
75	6	240	0,7	Nylon	1	D-45559	0088381408769	7,60

Cepillos de copa ondulada de alambre



- Muy eficaz para superficies planas o rugosas. Alambres ondulados para que la superficie terminada quede mucho más suave.



Ø (mm)	Inserción (mm)	Grano	Espesor (mm)	Tipo	Unds.	Código	EAN	P.V.P. (€)
38	6	-	-	Alambre	1	D-39908	0088381400022	1,95
50	6	-	-	Alambre	1	D-39914	0088381400039	2,20
63	6	-	-	Alambre	1	D-39920	0088381400046	2,45
75	6	-	-	Alambre	1	D-39936	0088381400053	2,70
80	6	-	-	Alambre	1	D-39942	0088381400060	3,25

Gratas de copa ondulada de alambre latonado



- Muy eficaz para superficies planas. Adecuado para la eliminación de óxido, barnices...Especialmente para madera.



D-73601

D-73623

D-73645

Ø (mm)	Inserción (mm)	Grano	Espesor (mm)	Tipo	Unds.	Código	EAN	P.V.P. (€)
	6	-	-	Latonado	1	D-73601	0088381586139	1,45
50	6	-	-	Latonado	1	D-73617	0088381586146	1,70
63	6	-	-	Latonado	1	D-73623	0088381586153	1,85
75	6	-	-	Latonado	1	D-73639	0088381586160	2,10
80	6	-	-	Latonado	1	D-73645	0088381586177	2,60

Cepillos de copa ondulada de alambre trenzado



- Muy eficaz para superficies planas. Adecuado para la eliminación de óxido, barnices...Especialmente para superficies metálicas.



D-73798

D-73807

Ø (mm)	Inserción (mm)	Grano	Espesor (mm)	Tipo	Unds.	Código	EAN	P.V.P. (€)
63	6	-	-	Trenzada	1	D-73798	0088381586429	4,65
75	6	-	-	Trenzada	1	D-73807	0088381586436	5,15

Cepillos de púas de nylon



- Ideal para superficies planas. Eliminación de óxido, limpieza de zonas de soldadura, barnices, etc.

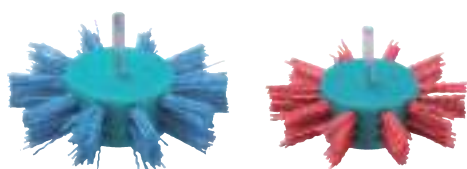

Ø (mm)	Inserción (mm)	Grano	Espesor (mm)	Tipo	Unds.	Código	EAN	P.V.P. (€)
100	6	80	1,4	Nylon	1	D-45749	0088381408950	8,20
100	6	240	0,7	Nylon	1	D-45755	0088381408967	8,20

Gratas para taladros

Cepillos oblicuos de nylon

★★

- Ideal para la limpieza en superficies estrechas, bordes o ranuras. Eliminación de óxido, esmaltes, barnices, etc. Tanto en metales, como en plásticos o maderas.



Ø (mm)	Inserción (mm)	Grano	Espesor (mm)	Tipo	Unds.	Código	EAN	P.V.P. (€)
38	6	80	1,4	Nylon	1	D-45565	0088381408776	3,85
50	6	80	1,4	Nylon	1	D-45571	0088381408783	4,65
63	6	80	1,4	Nylon	1	D-45587	0088381408790	4,90
75	6	80	1,4	Nylon	1	D-45593	0088381408806	6,55
100	6	80	1,4	Nylon	1	D-45602	0088381408813	7,60
38	6	240	0,7	Nylon	1	D-45618	0088381408820	3,85
50	6	240	0,7	Nylon	1	D-45624	0088381408837	4,65
63	6	240	0,7	Nylon	1	D-45630	0088381408844	4,90
75	6	240	0,7	Nylon	1	D-45646	0088381408851	6,55
100	6	240	0,7	Nylon	1	D-45652	0088381408868	7,60

Cepillos oblicuos de alambre

★★

- Muy eficaz para eliminar las rebabas y el óxido en trabajos finos.
- Alambres ondulados para que la superficie terminada quede mucho más suave.



Ø (mm)	Inserción (mm)	Grano	Espesor (mm)	Tipo	Unds.	Código	EAN	P.V.P. (€)
38	6	-	5	Alambre	1	D-39958	0088381400077	1,90
50	6	-	7	Alambre	1	D-39964	0088381400084	2,20
63	6	-	9	Alambre	1	D-39970	0088381400091	2,45
75	6	-	10	Alambre	1	D-39986	0088381400107	2,75
100	6	-	12	Alambre	1	D-39992	0088381400114	3,00

Cepillos oblicuos de alambre latonado

★★

- Muy eficaz para cepillar ranuras, especialmente en madera.



D-73651

D-73673

D-73695

Ø (mm)	Inserción (mm)	Grano	Espesor (mm)	Tipo	Unds.	Código	EAN	P.V.P. (€)
38	6	-	5	Latonado	1	D-73651	0088381586184	1,45
50	6	-	7	Latonado	1	D-73667	0088381586191	1,55
63	6	-	9	Latonado	1	D-73673	0088381586207	1,75
75	6	-	10	Latonado	1	D-73689	0088381586214	1,85
100	6	-	12	Latonado	1	D-73695	0088381586221	2,10

Cepillos oblicuos de alambre trenzado

★★

- Ideal para superficies estrechas y ranuras principalmente de metal.



D-73813

Ø (mm)	Inserción (mm)	Grano	Espesor (mm)	Tipo	Unds.	Código	EAN	P.V.P. (€)
75	6	-	-	Trenzada	1	D-73813	0088381586443	4,45
100	6	-	-	Trenzada	1	D-73829	0088381586450	4,65

Set de gratas de nylon para taladros

GRUESA (rojo) y FINA (azul)

★★

- Contiene copa ondulada 50 mm, cepillo oblicuo 50 mm y cepillo de acabado 24 mm.



Ø (mm)	Inserción (mm)	Grano	Espesor (mm)	Tipo	Unds.	Código	EAN	P.V.P. (€)
50	6	80	1,4	Nylon	1	D-70742	0088381556033	10,35
50	6	80	1,4	Nylon	1			
24	6	80	1,4	Nylon	1			

Ø (mm)	Inserción (mm)	Grano	Espesor (mm)	Tipo	Unds.	Código	EAN	P.V.P. (€)
50	6	240	0,7	Nylon	1	D-70758	0088381556040	10,35
50	6	240	0,7	Nylon	1			
24	6	240	0,7	Nylon	1			

Gratas para amoladoras

- Para la limpieza antes de la soldadura, oxidación y la limpieza de pintura, salpicaduras de soldadura. Eliminación de la corrosión del desbarbado, limpieza de barcos, tanques de acero, la preparación de superficies metálicas antes de pintar...



Makita

Forma



Copa ondulada

- Recomendado para la eliminación del óxido, barnices, esmaltes... de superficies metálicas.



Copa ondulada trenzada

- Alambre de acero más grueso para trabajos más exigentes que el tipo ondulado.
- Para superficies más amplias que el tipo recto.



Copa recta ondulada trenzada

- Para un acabado más suave
- Válido para madera, metal y PVC.



Cepillo oblicuo rizado

- Recomendado para la eliminación del óxido, barnices, esmaltes... de superficies metálicas en esquinas o lugares estrechos.



Cepillo oblicuo trenzado

- Alambre de acero más grueso para trabajos más exigentes que el cepillo oblicuo rizado.

Aplicación					
Madera	X	X	◆	X	X
PVC	X	X	◆	X	X
Metal	✓	✓	✓	✓	✓

✓ : Recomendado ◆ : Válido X: No recomendado

Gratas para amoladoras de acero

Copa ondulada de alambre



- Para superficies planas o rugosas. Alambres ondulados para que la superficie terminada quede mucho más suave.



Ø (mm)	Inserción (mm)	Espesor (mm)	Tipo	Unds.	Código	EAN	P.V.P. (€)
60	M14	0,3	Acero	1	D-24072	0088381313674	3,80
75	M14	0,3	Acero	1	D-24094	0088381313698	4,35
100	M14	0,3	Acero	1	D-29284	0088381345835	6,25
60	M14	0,3	Acero latonado	1	D-39746	0088381399869	3,85
75	M14	0,3	Acero latonado	1	D-39768	0088381399883	4,35
90	M14	0,3	Acero latonado	1	D-39780	0088381399906	5,45
100	M14	0,3	Acero latonado	1	D-39805	0088381399920	7,10

Copa ondulada de alambre trenzado



- Para superficies planas o rugosas. Alambre de acero más grueso que el tipo ondulado para trabajos más exigentes.



Ø (mm)	Inserción (mm)	Espesor (mm)	Tipo	Unds.	Código	EAN	P.V.P. (€)
60	M14	0,5	Acero	1	D-24119	0088381313711	5,20
75	M14	0,5	Acero	1	D-24131	0088381313735	5,75

Copa recta ondulada de alambre trenzado



- Para superficies planas o rugosas. Alambre de acero más grueso que el tipo ondulado para trabajos más exigentes.



Ø (mm)	Inserción (mm)	Espesor (mm)	Tipo	Unds.	Código	EAN	P.V.P. (€)
60	M14	0,5	Acero	1	D-24153	0088381313759	6,55
100	M14	0,5	Acero	1	D-29290	0088381345842	9,55

Cepillo oblicuo de alambre rizado



- Muy útil para limpiar esquinas o lugares estrechos donde los usuarios no pueden llegar con facilidad. Alambres oblicuos para que la superficie terminada quede mucho más suave.



Ø (mm)	Inserción (mm)	Espesor (mm)	Tipo	Unds.	Código	EAN	P.V.P. (€)
100	M14	0,3	Acero	1	D-39827	0088381399944	4,60
115	M14	0,3	Acero	1	D-39849	0088381399968	5,45

Cepillos oblicuo de alambre trenzado



- Muy útil para limpiar esquinas o lugares estrechos donde los usuarios no pueden llegar con facilidad. Alambres oblicuos para que la superficie terminada quede mucho más suave.



Ø (mm)	Inserción (mm)	Espesor (mm)	Tipo	Unds.	Código	EAN	P.V.P. (€)
100	M14	0,5	Acero	1	D-39861	0088381399982	5,20
115	M14	0,5	Acero	1	D-39883	0088381400008	5,45
115	M14	0,5	Acero	1	D-29561	0088381346726	6,00
125	M14	0,5	Acero	1	D-29577	0088381346733	7,90
150	M14	0,5	Acero	1	D-45761	0088381410328	10,35
175	M14	0,5	Acero	1	D-45777	0088381410335	13,10

Rodillos para N9741

Rodillo alambre acero latonado



- Ideal para veteado de maderas, duras o blandas. Adecuado para la abrasión fuerte de maderas blandas y duras. Para la desoxidación y limpieza.

Tipo	Unds.	Código	EAN	P.V.P. (€)
Acero latonado	1	P-65648	0088381996167	105,00

Rodillo púas acero



- Para desoxidación. Eliminación de barniz. Limpieza de piezas de encofrado de hormigón.

Tipo	Unds.	Código	EAN	P.V.P. (€)
Acero	1	P-04400	0088381914246	108,00

Rodillo de cerdas de fibra



- Para aplicación de nogalina y barniz y posterior pulido, así como abrillantado natural de madera.

Tipo	Unds.	Código	EAN	P.V.P. (€)
Fibra	1	P-04416	0088381914253	87,00

Rodillo para pulir de algodón



- Para pulir superficies, incluso con las cremas de pulido correspondientes para acero inoxidable, latón, etc.

Tipo	Unds.	Código	EAN	P.V.P. (€)
Algodón	1	794381-9	0088381139885	194,00

Rodillo de Nylon



- Para estructurar madera blanda y repasar madera dura estructurada. Para resaltar la estructura de la madera y eliminar eventuales fibras de madera. Para el tratamiento previo óptimo de la superficie a la posterior aplicación de barniz y nogalina. Para realizar una superficie rectificada en acero inoxidable y aluminio.

Grano	Tipo	Unds.	Código	EAN	P.V.P. (€)
60	Nylon	1	P-04422	0088381914260	103,00
80	Nylon	1	P-04438	0088381914277	104,00
80	Nylon	1	794384-3	0088381139915	164,00
100	Nylon	1	794379-6	0088381140232	153,00
120	Nylon	1	P-04444	0088381914284	104,00
180	Nylon	1	P-04450	0088381914291	104,00
240	Nylon	1	794383-5	0088381139908	156,00
320	Nylon	1	P-04466	0088381914307	103,00



Rodillo abrasivo



- Para el pulido de superficies metálicas planas. Muy recomendado para acero inoxidable.

Grano	Tipo	Unds.	Código	EAN	P.V.P. (€)
80	Abrasivo	1	P-18035	0088381944410	58,00
120	Abrasivo	1	P-18041	0088381944427	58,00
180	Abrasivo	1	P-18029	0088381944403	58,00

Rodillo abrasivo con lijas



- Para pulido de superficies metálicas planas. Muy recomendado para acero inoxidable. Lija y pule al mismo tiempo.

Grano	Tipo	Unds.	Código	EAN	P.V.P. (€)
80	Abrasivo	1	P-18057	0088381944434	64,00
120	Abrasivo	1	P-19233	0088381945844	64,00
180	Abrasivo	1	P-19249	0088381945851	64,00

Rodillo de lijas



- Para pulir superficies. Rascar pintura.

Grano	Tipo	Unds.	Código	EAN	P.V.P. (€)
40	Abrasivo	1	P-01127	0088381913904	61,00
80	Abrasivo	1	P-01155	0088381921596	61,00



Cuchillas HM y HSS ★★

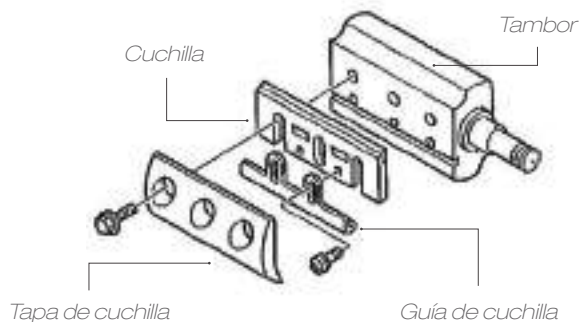

Modelo	Tipo	Longitud (mm)	Unds.	Código	EAN	P.V.P. (€)
1100 DKP180 DKP181 KP0800 KP0810 KP0810C	HSS	82	2	D-16346	0088381187756	6,80
	HM	82	2	D-07967	0088381181624	14,70
1911B	HSS	110	2	D-71211	0088381560160	14,30
	HSS	170	2	D-63666	0088381524070	25,00



Conjunto de mini-cuchillas + cuchillas HM / placas ★★

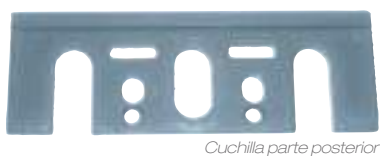

Modelos	Longitud (mm)	Detalle	Unds.	Código	EAN	P.V.P. (€)
1100 DKP180 DKP181 KP0800 KP0810 KP0810C	82	2+2	1	D-07951	0088381181617	12,45

Placa para mini-cuchillas



Modelos	Longitud (mm)	Unds.	Código	EAN	P.V.P. (€)
1100 DKP180 DKP181 KP0800 KP0810 KP0810C	82	1	343433-9	0088381151115	3,60

Mini-cuchillas

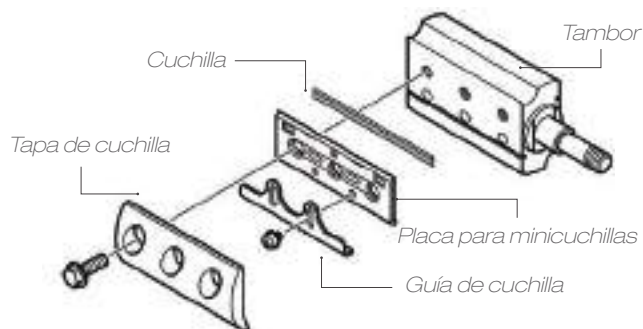

Modelo	Tipo	Longitud (mm)	Unds.	Código	EAN	P.V.P. (€)	
1050D 1051D	HM	50	2	A-85400	0088381148337	10,30	★★★
1100 DKP180 DKP181 KP0800 KP0810 KP0810C	HM	82	2	D-07945	0088381181600	11,10	★★
KP301	HSS	300	12	P-19831	0088381946445	139,00	★★★
2012NB	HSS	304	2	793346-8	0088381101042	39,00	★★★
KP312S	HSS	312	2	B-02870	0088381125840	36,00	★★★

Set de minicuchillas 82mm ★★

- Blister que contiene 5 paquetes de 2 Unds. de mini-cuchillas código D-07945. Los conjuntos pueden ser fácilmente separados para la venta individual de cada uno de ellos.
- Válido para los cepillos de 82 mm.



Longitud (mm)	Tipo	Unds.	Código	EAN	P.V.P. (€)
82	HM	5	D-35302	0088381367646	41,00

Guías paralelas



Tipo A



Tipo B



Tipo C

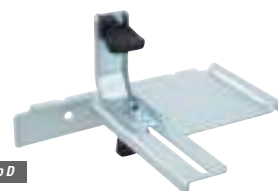

Tipo D

Modelo	Tipo	Unds.	Código	EAN	P.V.P. (€)
1100	A	1	161046-2	0088381122962	25,00
1806B	B	1	123053-3	008838115384	12,90
1902 1923B 1923H	C	1	165581-2	0088381361415	5,85
KP0800 DKP180	C	1	195055-9	0088381367110	9,95
KP0810 / C	D	1	122785-9	0088381346023	7,40
DKP181	D	1	191C23-8	0088381557429	29,00



Guía de profundidad



Modelos	Unds.	Código	EAN	P.V.P. (€)
KP0810 KP0810C KP0800 1923B 1923H	1	342390-8	0088381346412	2,05

Extensión para guías

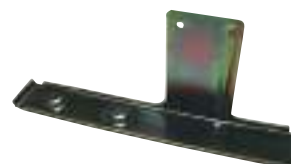

Modelos	Unds.	Código	EAN	P.V.P. (€)
1923B 1923H KP0800 DKP180	1	191725-8	0088381126946	13,40

Guía achaflanar



Pueden colocarse dos guías de achaflanar.

Modelos	Unds.	Código	EAN	P.V.P. (€)
KP0810 KP0810C	1	122791-4	0088381343190	27,00
DKP181	2	191C22-0	0088381557405	81,00

Mesa



Modelos	Unds.	Código	EAN	P.V.P. (€)
2012NB	1	193902-8	0088381186421	59,00

Soportes para cepillos



Modelos	Unds.	Código	EAN	P.V.P. (€)
1923H	1	STEX122338	0088381142618	80,00

Adaptador de aspiración

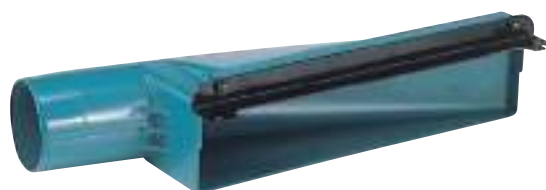

Modelo	Diámetro de salida	Unds.	Código	EAN	P.V.P. (€)
2012NB	76 mm	1	193036-7	0088381154390	27,00

Calibrador de cuchillas



Modelos	Unds.	Código	EAN	P.V.P. (€)
1100 1923B KP0800 KP0810/C DKP180 DKP181	1	123062-2	0088381111270	2,85

Piedra de asentar el filo



Longitud total (mm)	Unds.	Código	EAN	P.V.P. (€)
150	1	794061-7	0088381110174	10,80
180	1	794060-9	0088381103176	12,90

Llave hexagonal



Forma	mm	Unds.	Código	EAN	P.V.P. (€)
L	4,0	1	783202-0	0088381102667	1,05
T	4,0	1	783219-3	0088381369985	2,60
L	2,5	1	783208-8	0088381152624	1,05

Llave de tubo 9



Modelos	Unds.	Código	EAN	P.V.P. (€)
1100 KP0800 1923B KP312S KP0810/C	1	782209-3	0088381102568	2,10
2012NB	1	782203-5	0088381161367	2,90

Llave fija 8mm



Modelo	Unds.	Código	EAN	P.V.P. (€)
KP301	1	781213-9	0088381102520	2,05

Maestro de afilado



Modelos	Unds.	Código	EAN	P.V.P. (€)
1100 1923B KP0800 KP0810/C DKP180 DKP181	1	123004-6	0088381115391	3,10
1806B	1	123006-2	0088381115407	5,55

Bolsa de polvo



Modelos	Unds.	Código	EAN	P.V.P. (€)
1806B 1923B	1	122230-4	0088381114981	42,00
2012NB	1	STEX122312	0088381114974	64,00
KP0800 KP0810/C	1	122793-0	0088381346030	17,00
DKP181	1	191C21-2	0088381557450	29,00

Desviador de viruta



Modelos	Unds.	Código	EAN	P.V.P. (€)
1923H	1	122354-6	0088381114936	14,40
1100	1	415452-6	0088381142717	3,45
KP301	1	H311225	3240890101976	65,00
KP0800 KP0810/C	1	416368-8	0088381141703	2,05

Escuadra



Modelos	Unds.	Código	EAN	P.V.P. (€)
1806B 1923H KP312S	1	762001-3	0088381156912	0,80

Diamante

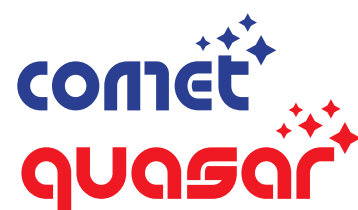

Protectores de disco para amoladoras.
Trabaja *sin polvo*. Cuida tu *salud*.



Discos de diamante



Discos de alta calidad para todo tipo de aplicaciones profesionales con la tecnología 3DDG de posicionamiento del diamante.

Tecnología STEALTH que utiliza 2 discos que hacen de molde sobre un núcleo de acero templado para reducir tanto las vibraciones como el ruido. Cortes más limpios y más rápidos.



30% MÁS DURACIÓN

50% MÁS RÁPIDO



La altura de los segmentos se incrementa hasta los 12mm.



Dientes en forma de M que habilitan un buen inicio del corte.

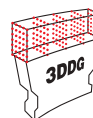

La tecnología 3D DiamondGrid es un avanzado método de fabricación del segmento que ordena los granos de diamante de forma paralela y uniforme por todo el segmento.

Soldadura láser que soporta grandes temperaturas.



Discos de diamante Quasar

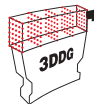

Hormigón



Mármol Terrazo



Ladrillo medio/duro



Teja cerámica



Pizarra blanda

- Quasar con cuerpo compacto, más silencioso, soldadura láser, banda segmentada, baja vibración, larga duración y tecnología STEALTH.

D (mm)	B (mm)	Reducción (mm)	S (mm)	Especificaciones	Unds.	Código	EAN	P.V.P. (€)
230	22,23	-	12	3DDG Stealth.	1	B-12712	0088381355452	138,00
300	20	-	12		1	B-13459	0088381359160	200,00
350	25,4	20	12		1	B-13465	0088381359177	258,00
400	25,4	20	12		1	B-13471	0088381359184	308,00

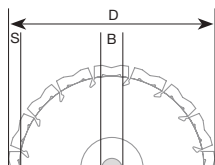

Discos de diamante



30% MÁS DURACIÓN

50% MÁS RÁPIDO

Aberturas de refrigeración para mantener el disco bien refrigerado durante el corte.

La altura de los segmentos se incrementa hasta los 10mm.

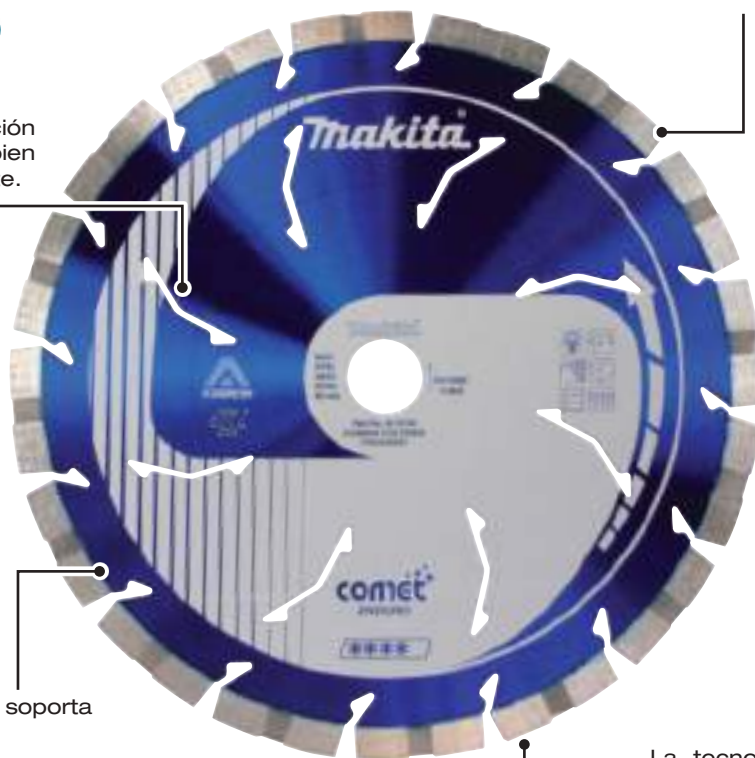

Dientes con rebaje en el centro que facilita la refrigeración.

Soldadura láser que soporta grandes temperaturas.

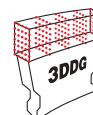

La tecnología 3D DiamondGrid es un avanzado método de fabricación del segmento que ordena los granos de diamante de forma paralela y uniforme por todo el segmento.



Discos de diamante COMET



- Cuerpo compacto, más silencioso.
- Con soldadura láser.
- Baja vibración.



Hormigón



Mármol
Terrazo



Ladrillo
medio/duro



Teja
cerámica



Pizarra
blanda

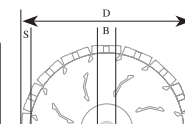
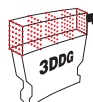

D (mm)	B (mm)	Reducción (mm)	S (mm)	Especificaciones	Unds.	Código	EAN	P.V.P. (€)
115	22,23	-	10	Aberturas de refrigeración	1	B-12762	0088381355506	45,00
125	22,23	20	10		1	B-12778	0088381355513	46,00
230	22,23	-	10	3DDG Aberturas de refrigeración Centro reforzado	1	B-12784	0088381355520	104,00
300	20	-	10		1	B-13546	0088381359252	155,00
350	25,4	20	10		1	B-13552	0088381359269	184,00
400	25,4	20	10		1	B-13568	0088381359276	222,00

Discos de diamante COMET banda turbo



- Disco con banda turbo con el que obtenemos un buen acabado de la pieza de trabajo.
- Aberturas de refrigeración que evita dilataciones en el disco.
- Con soldadura láser para soportar altas temperaturas.

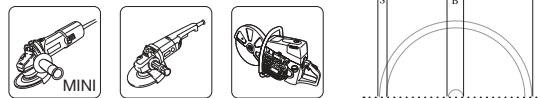

D (mm)	B (mm)	Reducción (mm)	S (mm)	Especificaciones	Unds.	Código	EAN	P.V.P. (€)
115	22,23	-	7	Banda turbo Núcleo estándar	1	B-12980	0088381358170	41,00
125	22,23	20	7		1	B-12996	0088381358187	46,00
150	22,23	20	7		1	B-13007	0088381358194	56,00
230	22,23	-	8		1	B-13035	0088381358224	91,00
300	25,4	-	8,5		1	B-13041	0088381358231	168,00
350	25,4	-	8,5		1	B-13057	0088381358248	220,00

Discos de diamante COMET banda continua



- Perfecto acabado en los materiales más duros.
- Se recomienda trabajar con agua para su buena refrigeración.
- Soldadura láser para soportar altas temperaturas.

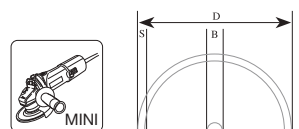

D (mm)	B (mm)	Reducción (mm)	S (mm)	Especificaciones	Unds.	Código	EAN	P.V.P. (€)
80	15	-	5	Banda continua Núcleo estándar	1	B-13063	0088381358255	71,00
115	22,23	-	5		1	B-13085	0088381358279	27,00
125	22,23	-	5		1	B-13091	0088381358286	29,00

Discos de diamante COMET banda continua electrodepositada



- Disco de banda continua con el diamante electrodepositado especial para materiales muy compactos y que necesiten un corte muy limpio para evitar roturas.

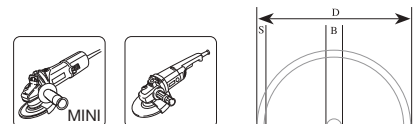

D (mm)	B (mm)	Reducción (mm)	S (mm)	Especificaciones	Unds.	Código	EAN	P.V.P. (€)
115	22,23	-	-	Electrodepositado Núcleo estándar	1	B-13172	0088381358378	54,00
125	22,23	20	-		1	B-13188	0088381358385	55,00
150	22,23	20	-		1	B-13194	0088381358392	74,00
230	22,23	-	-		1	B-13219	0088381358415	144,00
250	22,23	-	-		1	B-13225	0088381358422	263,00

Discos de diamante COMET especial juntas



- Diseño perfecto para en mortero, así como en materiales muy abrasivos.
- Para uso en mortero y ladrillo blando.
- Aberturas de refrigeración de gran tamaño.

• **Espesor 6,5mm**

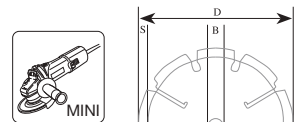

D (mm)	B (mm)	Reducción (mm)	S (mm)	Especificaciones	Unds.	Código	EAN	P.V.P. (€)
125	22,23	-	6,5	-	1	B-13253	0088381358453	96,00

Discos de diamante COMET especial asfalto



- Disco especial para trabajar en asfalto.
- Disco con pastilla de diamante de gran dureza ya que el asfalto es muy abrasivo.
- Banda segmentada para su refrigeración, pero se recomienda utilizar con cortadores de gasolina que tengan refrigeración con agua para una buena duración del disco.

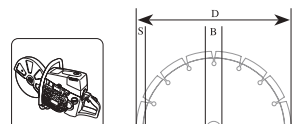

D (mm)	B (mm)	Reducción (mm)	S (mm)	Especificaciones	Unds.	Código	EAN	P.V.P. (€)
300	20	-	10	Asfalto Núcleo estándar	1	B-13269	0088381358460	173,00
350	25,4	20	10		1	B-13275	0088381358477	202,00

Discos de diamante NEBULA



- Discos de diamante de calidad estándar.
- Pro Segment / Laser Welding: reduce el sobrecalentamiento y ofrece una vida útil más larga.
- Para cortar hormigón, hormigón armado, ladrillo, piedra caliza y arenisca.

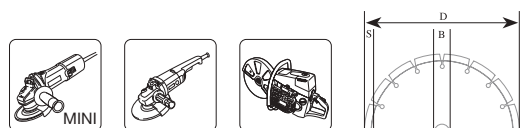

D (mm)	B (mm)	Reducción (mm)	S (mm)	Especificaciones	Unds.	Código	EAN	P.V.P. (€)
115	22,23	-	10	Soldadura láser	1	B-53986	0088381476485	23,00
125	22,23	-	10		1	B-53992	0088381476492	25,00
230	22,23	-	10		1	B-54025	0088381476522	33,00
300	20	-	10		1	B-54031	0088381476539	58,00
350	25,4	20	10		1	B-54053	0088381476553	74,00
400	25,4	20	10		1	B-54069	0088381476560	95,00



- Discos de uso general para el corte de todo tipo de materiales de obra.
- Apropiado para los materiales de mampostería.

Discos de diamante DIAMAK banda segmentada

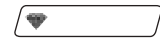

- Gama económica de discos para trabajos generales de obra. Puede ser utilizado tanto en cortes secos como en húmedos. Disponible en banda segmentada, turbo y banda continua.
- Todo tipo de mampostería, bloque, ladrillo, pizarra y piedra caliza.

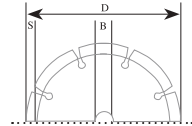

D (mm)	B (mm)	Reducción (mm)	S (mm)	Especificaciones	Unds.	Código	EAN	P.V.P. (€)
115	22,23	-	7	Banda segmentada Núcleo estándar	1	D-61123	0088381475778	8,15
125	22,23	-	7		1	D-52766	0088381445177	8,15
150	22,23	-	7		1	B-06432	0088381276122	21,00
230	22,23	-	7		1	D-61145	0088381475792	17,50
300	25,40	-	7,5		1	D-56982	0088381458085	63,00
350	25,40	-	7,5		1	D-56998	0088381458092	78,00
400	25,40	-	7,5		1	D-57009	0088381458108	91,00

Discos de diamante DIAMAK banda turbo



- Para materiales duros, granito, materiales arcillosos, pizarra, piedra caliza y hormigón duro.
- Banda segmentada.
- Núcleo estándar.

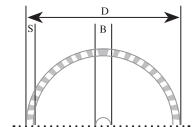

D (mm)	B (mm)	Reducción (mm)	S (mm)	Especificaciones	Unds.	Código	EAN	P.V.P. (€)
115	22,23	-	7	Banda segmentada Núcleo estándar	1	D-61151	0088381475808	8,15
125	22,23	20	7		1	D-61167	0088381475815	9,35
230	22,23	-	7		1	D-61173	0088381475822	20,95

Discos de diamante DIAMAK banda continua

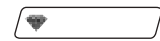

- Para materiales duros, granito, materiales arcillosos, pizarra, piedra caliza y hormigón duro.

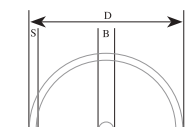

D (mm)	B (mm)	Reducción (mm)	S (mm)	Especificaciones	Unds.	Código	EAN	P.V.P. (€)
110	22,23	-	7	Banda continua Núcleo estándar	1	D-61189	0088381475839	7,00

Disco de diamante especial para herramientas a batería



- Nuevo disco de diamante de 230 mm ideal para cortadores a batería.
- Con este disco conseguimos aumentar la velocidad de corte y la vida útil del mismo.
- Para conseguir ranuras más estrechas, diseñamos el segmento en forma de abanico, obteniendo un mejor rendimiento de trabajo. Los diamantes se distribuyen regularmente en la estructura del segmento, así se logra un rendimiento de trabajo estable y reduce el consumo de batería.

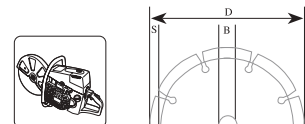

D (mm)	B (mm)	Reducción (mm)	S (mm)	Especificaciones	Unds.	Código	EAN	P.V.P. (€)
230	22,23	-	7	especial para DCE090	1	E-02967	0088381475792	139,00



Discos de diamante X-LOCK



- Disco de diamante segmentado X-LOCK 115x22,23 mm.
- Los discos de diamante compatibles con las amoladoras X-LOCK permiten una instalación de disco fácil y segura.

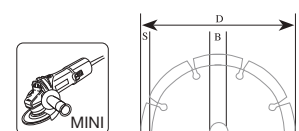

D (mm)	B (mm)	Reducción (mm)	S (mm)	Especificaciones	Unds.	Código	EAN	P.V.P. (€)
115	22,23	-	7	Compatible con amoladoras X-LOCK	1	E-02060	0088381556217	37,00
125	22,23	-	7		1	E-02076	0088381556224	40,00

Discos de diamante especial vidrio y porcelánico



- Segmentos continuos para un corte limpio sin rotura de las aristas de corte de azulejos, cerámica, mármol, vidrio, etc.



D (mm)	B (mm)	Modelo	Unds.	Código	EAN	P.V.P. (€)
85	15	CC301D	1	B-21098	0088381399777	35,00



- Segmento continuo e inclinado de anchura extra fina de 1,2 mm para el corte rápido y limpio de azulejos, mármol y vidrio.



D (mm)	B (mm)	Modelo	Unds.	Código	EAN	P.V.P. (€)
110	20	4101RH	1	B-22028	0088381401760	94,00



- Perfecto acabado en los materiales más duros. Se recomienda trabajar con agua para su buena refrigeración. Soldadura láser para soportar altas temperaturas. Indicado para hormigón y porcelánico (no válido para vidrio).



D (mm)	B (mm)	Modelo	Unds.	Código	EAN	P.V.P. (€)
125	20	4101RH	1	B-21951	0088381401692	37,00



- Especial porcelánico.
- Disco extrafino, ideal para máquinas a batería.
- 1,4 mm.



D (mm)	B (mm)	Modelo	Unds.	Código	EAN	P.V.P. (€)
115	22,23	Amoladoras 115 mm	1	B-46327	0088381452403	36,00



- Especial porcelánico.
- Disco extrafino, ideal para máquinas a batería.
- 1,4 mm.



D (mm)	B (mm)	Modelo	Unds.	Código	EAN	P.V.P. (€)
125	22,23	Amoladoras 125 mm	1	B-46333	0088381452410	39,00

Discos de diamante especial rescate



B-55326

- Corta todo tipo de materiales.
- Perfecto para operaciones de rescate.
- Muy utilizado en parques de bomberos.

D (mm)	B (mm)	Modelo	Unds.	Código	EAN	P.V.P. (€)
125	22,23	Amoladoras 125 mm	1	B-55310	0088381482035	52,00
230	22,23	Amoladoras 230 mm	1	B-55326	0088381482042	97,00
305	22,23	Amoladoras 305 mm	1	B-55332	0088381482059	175,00



Discos de diamante para pulir hormigón



B-12289

- Disco para limpiar y pulir superficies de hormigón y piedra natural con un acabado fino.



B-12295

- Disco para limpiar rápidamente capas gruesas de hormigón.



D-41464

- Gama económica.
- Disco para limpiar y pulir superficies de hormigón y piedra natural con un acabado fino.



D-41458

- Gama económica.
- Disco para limpiar rápidamente capas gruesas de hormigón.

D (mm)	B (mm)	Modelo	Unds.	Código	EAN	P.V.P. (€)
125	22,23	PC5010C	1	B-12289	0088381354042	210,00
125	22,23	PC5010C	1	B-12295	0088381354059	103,00
125	22,23	PC5010C	1	D-41464	0088381404280	62,00
125	22,23	PC5010C	1	D-41458	0088381404273	54,00

Brocas de diamante



Corte en seco - DBM130

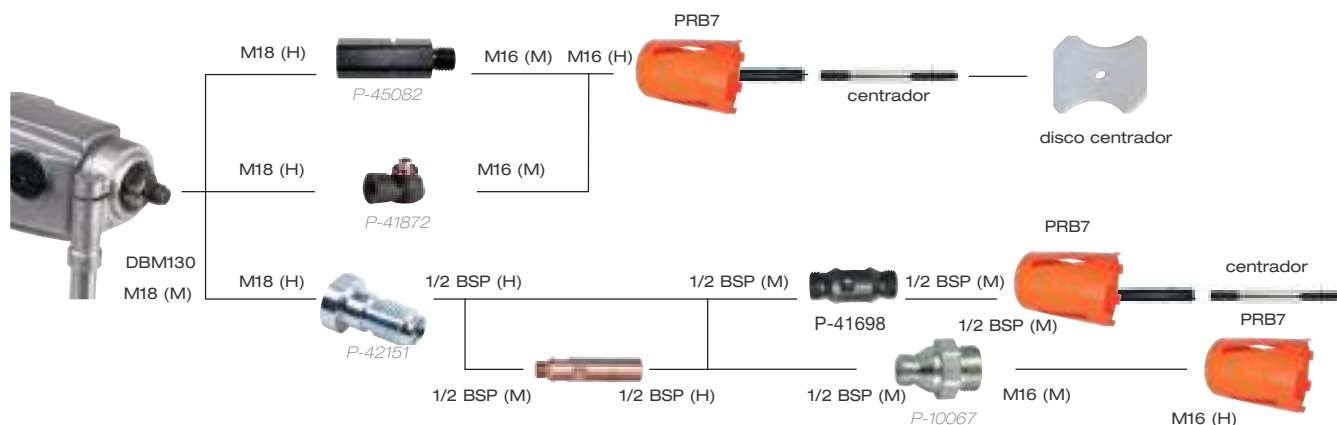

Brocas de corona de diamante para seco PRB7

- Brocas de diamante para todo tipo de mampostería.

Brocas de corona de diamante para seco DB4

- Brocas de diamante para granito, mármol, ladrillo duro y otros materiales abrasivos.

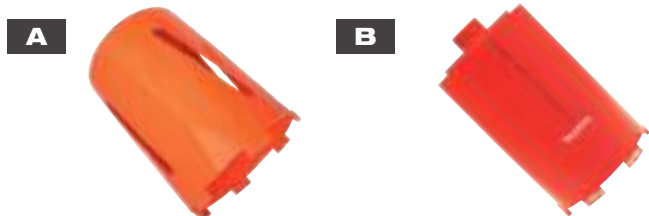

Tipo	Ø (mm)	Longitud (mm)	Inserción	Unds.	Código	EAN	P.V.P. (€)
A	22	300	1/2BSP (H)	1	P-57102	0088381987622	67,00
	28	300		1	P-57118	0088381987639	69,00
	32	150		1	P-57124	0088381987646	69,00
	38	150		1	P-57146	0088381987660	69,00
	48	150		1	P-57152	0088381987677	70,00
	65	150		1	P-57174	0088381987691	72,00
B	68	150	M16 (H)	1	P-63806	0088381994323	97,00
	76	150		1	P-63828	0088381994347	124,00
	132	150		1	P-63921	0088381994446	165,00



Ø (mm)	Longitud (mm)	Inserción	Unds.	Código	EAN	P.V.P. (€)
22	300	1/2BSP (H)	1	P-64060	0088381994583	39,00
28	300		1	P-64076	0088381994590	41,00
32	150		1	P-64082	0088381994606	43,00
38	150		1	P-64098	0088381994613	43,00
48	150		1	P-64107	0088381994620	47,00
52	150		1	P-64113	0088381994637	48,00
65	150		1	P-64129	0088381994644	49,00

Prolongadores para brocas de corona



Longitud (mm)	Inserción	Unds.	Código	EAN	P.V.P. (€)
100	5/4 UNC	1	P-41604	0088381968614	34,00
200		1	P-41610	0088381968621	39,00
300		1	P-41626	0088381968638	49,00
400		1	P-41632	0088381968645	63,00
500		1	P-41648	0088381968652	79,00
100	1/2 BSP	1	P-41551	0088381968560	24,00
300		1	P-34718	0088381963879	24,00



Centradores



Tipo	Medida	Unds.	Código	EAN	P.V.P. (€)
A	60(punta)	1	P-41888	0088381968294	25,00
B	340 (para punta)	1	P-41903	0088381968317	74,00
C	170	1	P-34724	0088381963886	17,50

Adaptadores para taladros de diamante



Máquina	Broca	Unds.	Código	EAN	P.V.P. (€)
5/4 UNC (F)	1/2 BSP (F)	1	P-41676	0088381968683	49,00
1/2 BSP (M)	5/4 UNC (M)	1	P-41682	0088381968690	48,00
1/2 BSP (M)	1/2 BSP (M)	1	P-41698	0088381968706	39,00
1/2 BSP (M)	M16(M)	1	P-10067	0088381931083	15,70
1/2 BSP (M)	M30(M)	1	P-10073	0088381931090	16,50
HI	1/2 BSP (F)	1	P-41707	0088381968713	45,00
M18(F) - 5/4 UNC (M)	1/2 BSP (F)	1	P-42151	0088381970020	33,00
M18(F)	M30(M)	1	P-41866	0088381968270	18,45
M18(F)	M16(M)	1	P-45082	0088381975193	35,00
SDS-PLUS	1/2 BSP (M)	1	P-30031	0088381958196	20,10
SDS-PLUS	M16(M)	1	P-67745	0088381998277	21,00

Disco centrador (para utilizar con centrador)



Medida	Unds.	Código	EAN	P.V.P. (€)
68	1	P-41919	0088381968324	3,35
82	1	P-41931	0088381968348	4,90
132	1	P-41981	0088381968393	10,80

Adaptador de aspiración



* Para trabajos en seco con DBM130 ó DBM131.

Rosca (máquina)	Rosca (broca)	Unds.	Código	EAN	P.V.P. (€)
De M18 x 2,5	M16x2,0	1	P-41872	0088381968287	134,00

Brocas de corona para amoladora (especial mármol)



- Perforación más rápida.
- Sencilla obtención del punto de taladrado basculando la máquina.
- Válidas para trabajar en mármol y granito.
- Sólo utilizar en seco.

Ø (mm)	Medida	Unds.	Código	EAN	P.V.P. (€)
25	M14	1	D-35025	-	21,25
30	M14	1	D-35019	-	25,00
35	M14	1	D-35003	0088381360272	26,00

Brocas especiales para amoladora (especial porcelánico)



D-44507



D-61070

Ø (mm)	Medida	Unds.	Código	EAN	P.V.P. (€)
6	M14	1	D-61070	0088381475532	17,40
8	M14	1	D-61086	0088381475549	17,95
10	M14	1	D-61092	0088381475556	18,50
12	M14	1	D-61101	0088381475563	26,00
14	M14	1	D-44432	0088381406758	36,00
20	M14	1	D-44454	0088381406772	28,00
25	M14	1	D-44476	0088381406796	35,00
32	M14	1	D-44507	0088381406826	44,00
38	M14	1	D-44529	0088381406840	55,00

Kit de recuperación de agua y de vacío

[1] sólo membrana



P-54178



P-54221

Descripción	Unds.	Código	EAN	P.V.P. (€)
[1] Membrana	1	P-54184	0088381984690	28,00
Kit recuperación de agua	1	P-54178	0088381984683	196,00
Kit fijación vacío	1	P-54221	0088381984737	97,00

Soporte para DBM131 y DBM130



Descripción	Unds.	Código	EAN	P.V.P. (€)
Soporte	1	P-40082	0088381967952	721,00

Soporte para DBM230



*Kit de anclaje igual que DBM131.

Descripción	Unds.	Código	EAN	P.V.P. (€)
Soporte	1	P-54190	0088381984706	1.324,00

Kit de anclaje para DBM131, DBM130 y DBM230

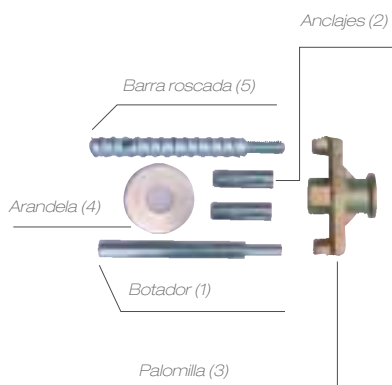

P-40098

Descripción	Unds.	Código	EAN	P.V.P. (€)
Kit fijación	1	P-40098	0088381967969	35,00
Botador (1)	1	P-40288	0088381968157	12,35
Anclajes (2)	1	P-40107	0088381967976	1,80
Palomilla (3)	1	P-40113	0088381967983	9,55
Arandela (4)	1	P-40129	0088381967990	4,40
Barra roscada (5)	1	P-41735	0088381968744	12,35

Accesorios para PW5000CH



Discos pulidores de diamante



- Discos pulidores de 100 mm para el perfecto pulido de la piedra.
- Fijación a la base por velcro.

Grano	Ø (mm)	Tipo	Color	Unds.	Código	EAN	P.V.P. (€)
50	100	Velcro	Azul	1	D-15584	0088381186759	14,85
200			Naranja	1	D-15609	0088381186773	14,85
800			Verde oscuro	1	D-15621	0088381186797	14,85
3.000			Marrón	1	D-15643	0088381186810	14,85
PIEL			Verde	1	D-15659	0088381186827	24,00

Plato de velcro



Ø (mm)	Tipo	Unds.	Código	EAN	P.V.P. (€)
100	Velcro	1	743080-0	0088381201223	25,00

Abrasivos amoladora



Alto Rendimiento Comparable con un modelo eléctrico



Equipadas con control automático de velocidad.

ADT

Cambia automáticamente la velocidad de corte ajustándose a la carga de trabajo para una operación óptima.

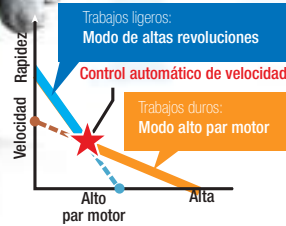

Función inteligente para minimizar el retroceso.

AFT

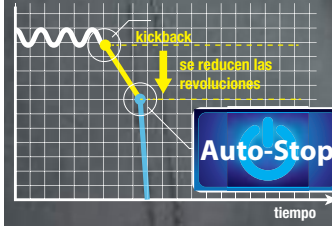

Apaga la herramienta para proteger al usuario, si la velocidad de rotación se desacelera repentinamente (por ejemplo, kick-back).

XLOCK

Nuevos discos para miniamoladoras 18V 115/125mm con sistema XLOCK. Permite cambiar el disco rápidamente, sin herramientas y sin esfuerzo.

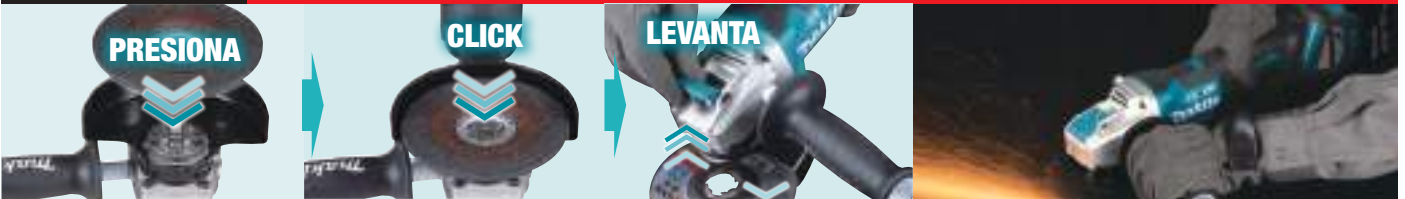

115 mm	125 mm	Batería	Velocidad (rpm)	Interruptor deslizante	Interruptor palanca	SAR Sistema Anti-Retroceso	Freno BRAKE	ADT	AFT
-	GA005G	XGT 40V Li-Ion max	8.500	✓	-	✓	✓	-	✓
-	GA013G		8.500	-	✓	✓	✓	-	✓
GA022G	-		3.000 - 8.500	✓	-	✓	✓	-	✓
-	GA023G		3.000 - 8.500	✓	-	✓	✓	-	✓
GA028G	-		3.000 - 8.500	-	✓	✓	✓	-	✓
-	GA029G		3.000 - 8.500	-	✓	✓	✓	-	✓
DGA452	-	18V LITH-ION	8.500	✓	-	✓	-	-	-
DGA454	DGA504		8.500	✓	-	✓	-	✓	-
DGA458	DGA508		8.500	-	✓	✓	✓	✓	✓
DGA461	DGA511		8.500	✓	-	✓	-	✓	✓
DGA463	DGA513		3.000 - 8.500	✓	-	✓	✓	✓	✓
DGA467	DGA517		3.000 - 8.500	-	✓	✓	✓	✓	✓
-	DGA518		8.500	-	✓	✓	✓	✓	✓
DGA469	DGA519		3.000 - 8.500	-	✓	✓	✓	✓	✓
150 mm	GA035G		XGT 40V Li-Ion max	8.500	✓	-	✓	✓	-
230 mm	DGA900 DGA901	20V+20V → 36V	3.000 - 8.500	-	✓	✓	-	✓	✓
	GA036G	XGT 40V Li-Ion max	8.500	-	✓	✓	✓	-	✓
	GA038G	XGT 40V Li-Ion max	6.600	-	✓	✓	✓	-	✓

Discos abrasivos de desbarbe



Material	Ø ext. (mm)	Ø int. (mm)	Espesor (mm)	Unds.	Código	EAN	P.V.P. (€)
Metal	115	22,23	6,4	1	P-52978	0088381983488	1,55
Metal	125	22,23	6,4	1	P-52984	0088381983495	1,80
Metal	150	22,23	6,4	1	P-52990	0088381983501	2,60
Metal	180	22,23	7	1	P-52227	0088381982733	3,10
Metal	230	22,23	7	1	P-52819	0088381983327	4,40

Discos abrasivos de desbarbe para metal especial industria pesada



Material	Ø ext. (mm)	Ø int. (mm)	Espesor (mm)	Unds.	Código	EAN	P.V.P. (€)
Inox	115	22,23	7,2	1	B-56378	0088381490061	3,60
Inox	125	22,23	7,2	1	B-56390	0088381490085	4,10

Discos abrasivos de corte



Material	Ø ext. (mm)	Ø int. (mm)	Espesor (mm)	Unds.	Código	EAN	P.V.P. (€)
Metal A	115	22,23	3,2	1	P-52174	0088381982689	1,10
	125	22,23	3,2	1	P-52180	0088381982696	1,30
	150	22,23	3,2	1	P-52928	0088381983433	1,80
	180	22,23	3,2	1	P-52934	0088381983440	1,80
	230	22,23	3,2	1	P-52196	0088381982702	2,40
Piedra B	115	22,23	3,2	1	P-52205	0088381982719	1,30
	125	22,23	3,2	1	P-52940	0088381983457	1,55
	180	22,23	3,2	1	P-52962	0088381983471	2,05
	230	22,23	3,2	1	P-52211	0088381982726	2,85
Metal C	300	25,4	3	1	P-53148	0088381983655	3,85
	350	25,4	3	1	P-53154	0088381983662	5,15
Piedra D	300	20	3,2	1	721710-3	-	15,45
	350	25,4	4	1	721715A3	-	23,00
	400	20	4,7	1	724406-5	-	43,00

Discos abrasivos de desbarbe



Material	Ø ext. (mm)	Ø int. (mm)	Espesor (mm)	Unds.	Código	EAN	P.V.P. (€)
Metal	115	22,23	6	1	E-00365	0088381555395	1,75
Metal	125	22,23	6	1	E-00393	0088381555425	2,05
Inox	115	22,23	6	1	E-00371	0088381555401	2,25
Inox	125	22,23	6	1	E-00402	0088381555432	2,80

Discos abrasivos extrafinos de corte



Material	Ø ext. (mm)	Ø int. (mm)	Espesor (mm)	Unds.	Código	EAN	P.V.P. (€)
Metal	115	22,23	1,2	1	E-00387	0088381555418	1,85
Metal	125	22,23	1,2	1	E-00418	0088381555449	2,05

Discos abrasivos extrafinos de corte



Material	Ø ext. (mm)	Ø int. (mm)	Espesor (mm)	Unds.	Código	EAN	P.V.P. (€)
Metal A	115	22,23	1	1	P-53001	0088381983518	1,30
	115	22,23	1,6	1	P-53017	0088381983525	1,30
	125	22,23	1	1	P-53023	0088381983532	1,35
	125	22,23	1,6	1	P-53039	0088381983549	1,35
	230	22,23	2	1	P-52233	0088381982740	3,10
	Inox B	115	22,23	1	1	P-52249	0088381982757
115		22,23	1,6	1	P-52255	0088381982764	1,30
125		22,23	1	1	P-53045	0088381983556	1,30
125		22,23	1,6	1	P-53051	0088381983563	1,35
230		22,23	2	1	P-53067	0088381983570	3,10
Piedra C	115	22,23	1	1	P-53073	0088381983587	1,30
	115	22,23	1,6	1	P-53089	0088381983594	1,80
	125	22,23	1	1	P-53095	0088381983600	1,35
Aluminio D	115	22,23	1,6	1	P-53126	0088381983631	1,30

Paquetes de discos de corte fino



Material	Ø ext. (mm)	Ø int. (mm)	Espesor (mm)	Unds.	Código	EAN	P.V.P. (€)
Inox	115	22,23	1	10	D-65953-10	0088381561815	6,90
Inox	125	22,23	1	10	D-65969-10	0088381561822	7,95
Inox	115	22,23	0.8	12	E-10861-12	-	19,55
Inox	125	22,23	0.8	12	E-10877-12	-	22,00

Nuevos discos abrasivos multimaterial



Disco abrasivo para DCE090

- Para corte rápido.
- Produce menos polvo y rebaba de los materiales.



Material	Ø ext. (mm)	Ø int. (mm)	Espesor (mm)	Unds.	Código	EAN	P.V.P. (€)
Inox	230	22,23	2	25	E-03006-25	0088381567442	57,00

Discos abrasivos multimaterial

- El disco de corte de espesor delgado, se adapta a múltiples materiales.
- Son adecuados para usar en construcción, fontanería, etc.



Material	Ø ext. (mm)	Ø int. (mm)	Espesor (mm)	Unds.	Código	EAN	P.V.P. (€)
Multi material	115	22,23	1,2	1	E-10718	0088381580526	1,55
Multi material	125	22,23	1,2	1	E-10724	0088381580533	1,80

Discos abrasivos para cortadores



Material	Ø ext. (mm)	Ø int. (mm)	Espesor (mm)	Unds.	Código	EAN	P.V.P. (€)
Metal	355	25,4	3	5	B-10665-5	0088381348058	21,00
Aluminio	355	25,4	2,8	5	E-04977-5	-	39,00

Piedras de amolar



Grano	Ø ext. (mm)	Ø int. (mm)	Espesor (mm)	Unds.	Código	EAN	P.V.P. (€)
Para GS5000							
24	125	20	20	1	B-28662	0088381414890	57,00
36	125	20	20	1	B-28678	0088381414906	57,00
Para GS6000							
24	150	20	20	1	B-28684	0088381414913	72,00
36	150	20	20	1	B-28690	0088381414920	72,00

Nuevas

Para GB801							
120	205	15,88	19	1	B-51976	0088381467490	28,00
60	205	15,88	19	1	B-51960	0088381467483	22,00
Para GB602							
120	150	12,7	16	1	B-51932	0088381467452	15,40
60	150	1,7	16	1	B-51926	0088381467445	13,80

Discos de láminas

- Para desbarbar, desoxidar, limpiar o rebajar los cordones de soldadura en metales, aluminio y otras aleaciones.
- También podemos aplicarlos en trabajos de carpintería, decapado de muebles, lijado de masillas, trabajos en vigas viejas etc...
- Cuerpo de fibra de vidrio: el más común dentro del mercado. Disco más económico que el de nylon, ofrece: Ligereza y flexibilidad.
- Cuerpo de nylon: para los trabajos de lijado más exigentes. Están indicados para lijados donde debemos ejercer gran presión sobre el material. Mayor rendimiento y mayor calidad.
- Forma del disco curvo: permite trabajos en superficie con forma. Ideal para el lijado de tubos así como cordones de soldadura.
- Forma del disco plano: perfecto para los trabajos en superficies planas, consiguiendo así un acabado más uniforme en este tipo de superficies.

Tabla de aplicación

Madera		★★★★★			
Plástico		★★★★★			
Metales		★★★★★	★★★★★	★★★★★	
Metales no férricos		★★★★★	★★★★★	★★★★★	
Acero Inox			★★★★★	★★★★★	
Ladrillo, piedra, hormigón					★★★★★

Discos de láminas - Óxido de aluminio



- Discos con abrasivo de óxido de aluminio, válidos para gran variedad de materiales: metales férricos, no férricos, plásticos y madera.



Tipo Curvo



Cuerpo de fibra de vidrio

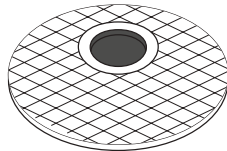

Materiales



Metal



Plástico



Madera



Metales no férricos



Ø ext. (mm)	Ø int. (mm)	Grano	R.p.m	Unds.	Código	EAN	P.V.P. (€)
115	22,23	40	13.290	1	D-27034	0088381343633	3,15
		60	13.290		D-27040	0088381343640	3,15
		80	13.290		D-27056	0088381343657	3,15
		120	13.290		D-27062	0088381343664	3,15
125	22,23	40	13.290	1	D-27084	0088381343688	3,60
		60	13.290		D-27090	0088381343695	3,60
		80	13.290		D-27109	0088381343701	3,60
		120	13.290		D-27115	0088381343718	3,60
180	22,23	40	8.600	1	D-27137	0088381343732	7,20
		60	8.600		D-27143	0088381343749	7,20
		80	8.600		D-27159	0088381343756	7,20
		120	8.600		D-27165	0088381343763	7,20

Discos de láminas - Óxido de aluminio cerámico



- Ideal para inoxidable, titanio, níquel y otros metales de gran densidad.
- La gama alta de los discos de láminas.



Tipo curvo



Cuerpo de fibra de vidrio

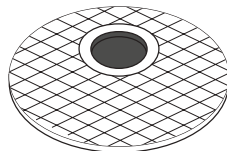

Materiales



Metal



Acero inoxidable



Metales no férricos



Ø ext. (mm)	Ø int. (mm)	Grano	R.p.m	Unds.	Código	EAN	P.V.P. (€)
115	22,23	40	13.290	1	D-28298	0088381344890	6,45
		60	13.290		D-28307	0088381344906	6,45
		80	13.290		D-28313	0088381344913	6,45
		120	13.290		D-28329	0088381344920	6,45
125	22,23	40	13.290	1	D-28335	0088381344937	7,45
		60	13.290		D-28341	0088381344944	7,45
		80	13.290		D-28357	0088381344951	7,45
		120	13.290		D-28363	0088381344968	7,45
180	22,23	40	8.600	1	D-28379	0088381344975	13,40
		60	8.600		D-28385	0088381344982	13,40
		80	8.600		D-28391	0088381344999	13,40
		120	8.600		D-28400	0088381345002	13,40

Discos de láminas - Zirconio



- Discos con abrasivo de Zirconio perfecto para los trabajos en metales y trabajos en acero inoxidable.
- “El disco más popular del mercado”.



Ø ext. (mm)	Ø int. (mm)	Grano	R.p.m	Unds.	Código	EAN	P.V.P. (€)
115		40	13.290	1	D-53724	0088381445320	2,90
		60	13.290		D-53730	0088381445337	2,90
		80	13.290		D-53746	0088381445344	2,90
		120	13.290		D-53752	0088381445351	2,90
125	22,23	40	13.290	1	D-53774	0088381445375	3,35
		60	13.290		D-53780	0088381445382	3,35
		80	13.290		D-53796	0088381445399	3,35
		120	13.290		D-53805	0088381445405	3,35
180		40	8.600	1	D-53827	0088381445429	7,45
		60	8.600		D-53833	0088381445436	7,45
		80	8.600		D-53849	0088381445443	7,45
		120	8.600		D-53855	0088381445450	7,45



Ø ext. (mm)	Ø int. (mm)	Grano	R.p.m	Unds.	Código	EAN	P.V.P. (€)
115		40	13.290	1	D-63747	0088381525350	1,85
		60	13.290		D-63753	0088381525367	1,85
		80	13.290		D-63769	0088381525374	1,85
		120	13.290		D-63775	0088381525381	1,85
125	22,23	40	13.290	1	D-63781	0088381525398	2,15
		60	13.290		D-63797	0088381525404	2,15
		80	13.290		D-63806	0088381525411	2,10
		120	13.290		D-63812	0088381525428	2,10
180		40	8.600	1	D-63828	0088381525435	4,25
		60	8.600		D-63834	0088381525442	4,25
		80	8.600		D-63840	0088381525459	4,25
		120	8.600		D-63856	0088381525466	4,25

- Los discos de nylon son ideales para los trabajos de lijado más exigentes. Están indicados para lijados donde debemos ejercer gran presión sobre el material, consiguiendo así un poder de lijado mayor que con cualquier otro disco.
- Ofrecen mayor rendimiento y mayor calidad. Mantienen las láminas hasta la terminación del abrasivo.

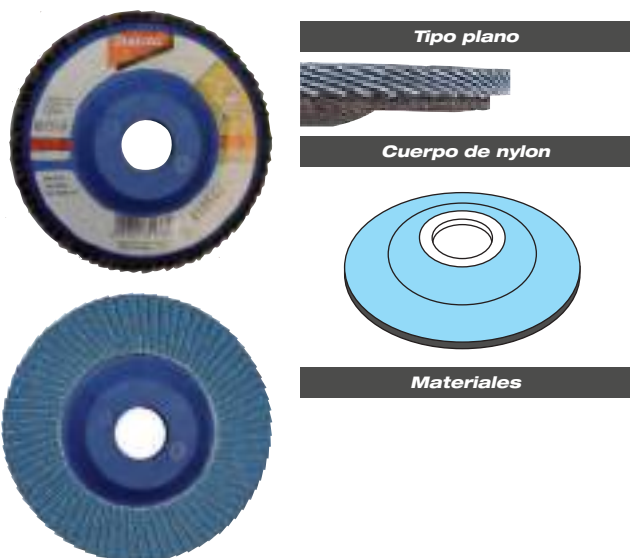

Ø ext. (mm)	Ø int. (mm)	Grano	R.p.m	Unds.	Código	EAN	P.V.P. (€)
115		40	13.290	1	D-27838	0088381344432	5,15
		60	13.290		D-27844	0088381344449	5,15
		80	13.290		D-27850	0088381344456	5,15
		120	13.290		D-27866	0088381344463	5,15
125	22,23	40	13.290	1	D-27888	0088381344487	6,20
		60	13.290		D-27894	0088381344494	6,20
		80	13.290		D-27903	0088381344500	6,20
		120	13.290		D-27919	0088381344517	6,20
180		40	8.600	1	D-27931	0088381344531	10,30
		60	8.600		D-27947	0088381344548	10,30
		80	8.600		D-27953	0088381344555	10,30
		120	8.600		D-27969	0088381344562	10,30

Discos de láminas - Carburo de silicio



- Discos con abrasivo de carburo de silicio muy efectivo en materiales como el ladrillo, piedra y hormigón.
- No es necesario trabajarlo con agua.



Tipo plano



Cuerpo de fibra de vidrio

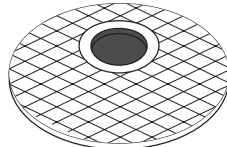

Materiales

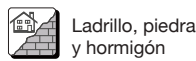

Ø ext. (mm)	Ø int. (mm)	Grano	R.p.m	Unds.	Código	EAN	P.V.P. (€)
115	22,23	40	13.290	1	D-28036	0088381344630	3,70
		60	13.290		D-28042	0088381344647	3,70
		80	13.290		D-28058	0088381344654	3,70
		120	13.290		D-28064	0088381344661	3,70
125	22,23	40	13.290	1	D-28086	0088381344685	4,20
		60	13.290		D-28092	0088381344692	4,20
		80	13.290		D-28101	0088381344708	4,20
		120	13.290		D-28117	0088381344715	4,20
180	22,23	40	8.600	1	D-28139	0088381344739	7,20
		60	8.600		D-28145	0088381344746	7,20
		80	8.600		D-28151	0088381344753	7,20
		120	8.600		D-28167	0088381344760	7,20

- Discos de nylon para los trabajos más exigentes. Indicados para lijados donde debemos ejercer gran presión sobre el material, consiguiendo así un poder de lijado mayor. Mayor rendimiento y mayor calidad.



Tipo plano



Cuerpo de nylon

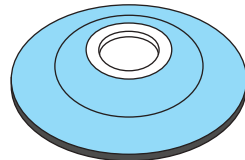

Materiales

Ø ext. (mm)	Ø int. (mm)	Grano	R.p.m	Unds.	Código	EAN	P.V.P. (€)
115	22,23	40	13.290	1	D-28173	0088381344777	5,15
		60	13.290		D-28189	0088381344784	5,15
		80	13.290		D-28195	0088381344791	5,15
		120	13.290		D-28204	0088381344807	5,15
180	22,23	40	8.600	1	D-28210	0088381344814	10,30
		60	8.600		D-28226	0088381344821	10,30
		80	8.600		D-28232	0088381344838	10,30
		120	8.600		D-28248	0088381344845	10,30

Discos abrasivos - Scotch

- Discos abrasivos de Scotch indicados para la limpieza de superficies metálicas, de acero inoxidable o de metales no ferrosos. También pueden ser utilizados en superficies pulidas de piedra.
- El acabado que conseguimos con estos discos es mejor que el conseguido con discos de láminas y discos de desbaste.
- Con este tipo de discos no es necesario realizar demasiada presión, obtenemos un buen lijado con poca fuerza, así conseguiremos un muy buen acabado y una mayor duración del disco.
- Para superficies irregulares como la chapa palillo son ideales gracias a la ligera flexibilidad de los discos.

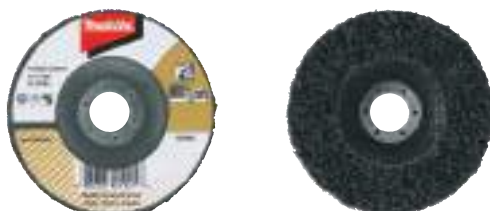

Ø ext. (mm)	Ø int. (mm)	Unds.	Código	EAN	P.V.P. (€)
115	22,23	1	B-28977	0088381415200	9,55
125	22,23	1	B-28983	0088381415217	10,55

Discos de láminas - Vellón

- Indicado para el pulido del metal. Perfecto para aceros fuertes y aleados resistentes a la corrosión.
- Contiene poco Fe, S y Cl, por lo que es resistente al óxido.
- Dependiendo del grosor de la fibra podemos desde eliminar rebaba hasta pulir.
- Cubierto por una resina de alúmina que permite trabajar más rápido y con menos potencia.
- Las fibras de vellón evitan la abrasión del material.



Las fibras de vellón finas y flexibles ofrecen un buen acabado de la superficie. Hasta el doble de duración que otros discos de vellón. Ideal para utilizar después de un disco abrasivo



Ø ext. (mm)	Ø int. (mm)	Grano	Unds.	Código	EAN	P.V.P. (€)
115	22,23	Grueso	1	B-40917	0088381439237	9,55
125		Grueso		B-40951	0088381439275	11,05
115		Medio		B-40923	0088381439244	9,55
125		Medio		B-40967	0088381439282	11,05
115		Fino		B-40939	0088381439251	9,55
125		Fino		B-40973	0088381439299	11,05
115		Super fino		B-40945	0088381439268	9,55
125		Super fino		B-40989	0088381439305	11,05

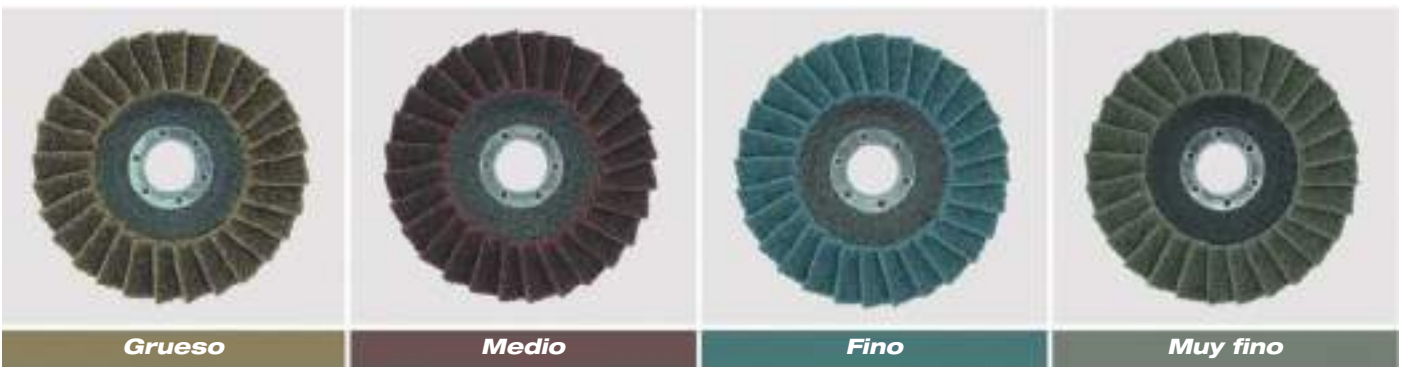

Aplicación



Limpieza en cordones de soldadura

Pulido en óxido

Pulido



Muelas abrasivas



Modelo	Tipo de abrasivo	Inserción	Ø de la muela (mm)	Unds.	Código	EAN	P.V.P. (€)
GD0600 GD0601 GD0602 GD0603	A para acero medio	3	5	1	794050-2	0088381110211	1,30
GD0800C GD0801C GD0810C GD0811C		3	6	1	794051-0	0088381110228	1,30
		3	10	1	794053-6	0088381110242	1,30
		3	10	1	794059-4	0088381110303	2,85

Empuñaduras

Modelo	Descripción	Unds.		Código	EAN	P.V.P. (€)	
Para amoladoras de: 115 mm 125 mm 150 mm	Rígida	1		153489-2	0088381193054	1,10	
	Antivibración	1		162258-0	0088381343381	12,85	
Para amoladoras: 9015B 9016B Lijadora 9218SB	Rígida	1		152492-0	0088381131599	2,85	
Para amoladoras: 180 mm 230 mm	Rígida	1		151776-3	0088381156073	10,80	
Para amoladoras: 180 mm 230 mm	Antivibración	1		162264-5	0088381345828	15,00	
	De corte	1		194684-5	0088381349895	13,80	

Colectores de polvo

El polvo puede causar graves enfermedades respiratorias. Para tratar de evitarlas Makita recomienda utilizar colector de polvo con una tasa de aspiración hasta del 90% de las partículas. Carcasa en aluminio para una mayor duración. Posibilidad de bloquear el disco a la profundidad deseada. Visor con protector transparente.

Colector de polvo amoladoras 230 mm

Colector de polvo amoladoras 125 mm



Diámetro (mm)	Descripción	Unds.	Código	EAN	P.V.P. (€)
230	Aluminio. Posibilidad de bloquear el disco. Visor transparente.	1	198440-5	0088381487368	136,00



Diámetro (mm)	Descripción	Unds.	Código	EAN	P.V.P. (€)
125	Aluminio. Posibilidad de bloquear el disco. Visor transparente.	1	196845-3	0088381442527	76,00
125	Con enganche rápido sin herramientas*	1	191G06-2	0088381566001	81,00

* Para amoladoras con enganche rápido de disco.

Colectores de polvo aptos para amoladoras de 115mm, 125mm y 180mm. Especial para su uso en lijados con discos de diamante en hormigón. Modelos de amoladoras compatibles: potencia 1.100W o superior. Alta capacidad de aspiración. Apta para rincones gracias a su sistema de dos piezas.

Modelos	Diámetro (mm)	Descripción	Unds.	Código	EAN	P.V.P. (€)
Amoladoras 115 / 125 mm X-LOCK.	115 / 125	Especial para su uso en lijados con discos.	1	191F81-2	0088381565479	49,00
Amoladoras 115 mm / 125 mm.	115 / 125		1	195239-9	0088381361804	49,00
Amoladoras 180 mm.	180		1	195385-8	0088381369381	66,00



Protectores de disco

Tipo estándar



Tornillo



Rápido

Modelos	Ø (mm)	Cierre	Unds.	Código	EAN	P.V.P. (€)
9557NBR	115	Tornillo	1	123098-1	0088381451383	7,20
9557NBRK1			1	123098-1	0088381451383	7,20
9557NBRX2			1	123098-1	0088381451383	7,20
9558NBR	125	Tornillo	1	123099-9	0088381451390	7,75
9558NBRK1			1	123099-9	0088381451390	7,75
9558PBY			1	123099-9	0088381451390	7,75
9565CR	125	Rápido	1	123145-8	0088381420181	9,10
9565CVR			1	123145-8	0088381420181	9,10
9565PCV			1	123145-8	0088381420181	9,10
9566PCV01	150		1	123146-6	0088381420198	11,35
GA4530R	115	Tornillo	1	123098-1	0088381451383	7,20
GA4534			1	123098-1	0088381451383	7,20
GA4540C		Rápido	1	123144-0	0088381420167	9,75
GA4540RZ	Tornillo	1	123098-1	0088381451383	7,20	
GA5021C	125	Rápido	1	123145-8	0088381420181	9,10
GA5030R		Tornillo	1	123099-9	0088381451390	7,75
GA5034			1	123099-9	0088381451390	7,75
GA5040C		Rápido	1	123145-8	0088381420181	9,10
GA5040C01		Rápido	1	123145-8	0088381420181	9,10
GA5040RZ		Tornillo	1	123099-9	0088381451390	7,75
GA6021C	150	Rápido	1	123146-6	0088381420198	11,35
GA6040C			1	123146-6	0088381420198	11,35
GA7012C	180	Tornillo	1	122846-5	3240890337726	13,05
GA7020R			1	122889-7	0088381364447	8,95
GA7030R			1	122889-7	0088381364447	8,95
GA7040R			1	122889-7	0088381364447	8,95
GA7050			1	122889-7	0088381364447	8,95
GA7050R			1	122889-7	0088381364447	8,95
GA7060R			1	122889-7	0088381364447	8,95
GA7061R			1	122889-7	0088381364447	8,95
GA9012C			Rápido	1	163411-1	0088381201155
GA9020R	230	Tornillo	1	122891-0	3240890337696	10,30
GA9020RKD			1	122891-0	3240890337696	10,30
GA9020SFYK			1	122891-0	3240890337696	10,30
GA9030R			1	122891-0	3240890337696	10,30
GA9040R			1	122891-0	3240890337696	10,30
GA9050			1	122891-0	3240890337696	10,30
GA9050R			1	122891-0	3240890337696	10,30
GA9060R			1	122891-0	3240890337696	10,30
GA9061R			1	122891-0	3240890337696	10,30

Tipo especial para corte con disco abrasivo



122913-6



199709-0



Ø (mm)	Cierre	Unds.	Código	EAN	P.V.P. (€)
125 mm	Tornillo	1	122911-0	0088381367134	8,30
230 mm		1	122913-6	0088381367141	16,30
115 mm	Para colocar sobre protector	1	199709-0	0088381544665	9,40
125 mm		1	199710-5	0088381544672	9,90

Arandela centradora y tuerca



224415-9



224543-0

Descripción	Tipo	Modelos	Unds.	Código	EAN	P.V.P. (€)
Arandela	M14	"Ø 115, Ø 125, Ø 150, Ø 180, Ø 230 mm."	1	224415-9	0088381348256	1,50
Tuerca	M14		1	224543-0	0088381116176	1,95

Tipo especial para limpieza con gratas



Ø (mm)	Cierre	Unds.	Código	EAN	P.V.P. (€)
60 - 75 mm	Tornillo	1	192454-6	0088381200912	39,00

Protector para amoladoras rectas



Modelos	Ø (mm)	Cierre	Unds.	Código	EAN	P.V.P. (€)
GS5000	125	Tornillo	1	123199-5	3240890390677	22,00
GS6000	150			123200-6	-	23,00

Tuerca de cierre rápido Ezynt



Descripción	Tipo	Modelos	Unds.	Código	EAN	P.V.P. (€)
Tuerca rápida	M14	Amoladoras 180mm y 230mm	1	195354-9	0088381367189	41,00

Super - Flange (autoapretante)



Descrip.	Tipo	Modelos	Unds.	Código	EAN	P.V.P. (€)
Arandela	M14	Todos los modelos	1	192227-7	0088381117371	14,40
Tuerca	M14		1	125052-1	0088381155960	11,35

Set de filtros

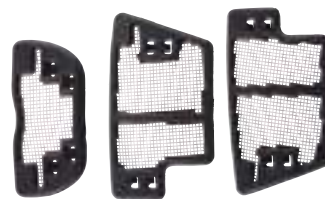

Modelos	Unds.	Código	EAN	P.V.P. (€)
GA4550R GA5050R	1	199514-5	0088381586559	26,00
GA4540R GA4540C GA5040R GA5040C GA6040C SA5040C	1	198719-4	0088381534857	16,05
9565CR 9565CVR	1	193903-6	0088381187619	14,95
9565PCV	1	195446-4	0088381486057	11,35
GA7012C GA9012C GA5021C GA6021C	1	193956-5	0088381191982	8,50
GA7020R GA7030R GA7040R GA9020R GA9030R GA9040R	1	194289-1	0088381341950	2,05



Amoladoras angulares



Amoladoras rectas



Amoladoras rectas con discos



Casquillos cónicos para amoladoras rectas



Tuerca



Casquillo



Modelo	Ø (mm)	Descripción	Unds.	Código	EAN	P.V.P. (€)
GD0600 GD0601	3	Casquillo	1	763627-4	0088381114769	12,35
	6		1	763620-8	0088381114776	10,10
	6,35 (1/4")		1	763625-8	0088381102339	11,85
	-	Tuerca	1	763664-8	3240890340672	1,30
GD0602 DGD800	3	Casquillo	1	763669-8	0088381435925	17,00
	6		1	763670-3	0088381435932	8,50
	8		1	763671-1	0088381435949	17,00
	-	Tuerca	1	763668-0	0088381495714	1,55
GD0603	6	Casquillo	1	763620-8	0088381114776	10,10
	-	Tuerca	1	763236-9	0088381495684	2,95
GD0800C GD0801C GD0810C GD0811C	3	Casquillo + Tuerca	1	193011-3	0088381156394	23,00
	6		1	193012-1	0088381156400	19,05
	6,35 (1/4")		1	193143-6	0088381156363	23,00
	8		1	192988-9	0088381156387	24,00
	6	Casquillo	1	763646-0	0088381170345	14,40
	-	Tuerca	1	763645-2	0088381170338	2,45



Soporte



Modelos	Unds.	Código	EAN	P.V.P. (€)
GD0800C GD0810C	1	193141-0	0088381156745	64,00

Empuñadura lateral



Modelos	Unds.	Código	EAN	P.V.P. (€)
GD0600C GD0601C GD0800C GD0810C	1	192985-5	0088381156417	14,00

Llaves para amoladoras rectas



Modelo	Medida (mm)	Unds.	Código	EAN	P.V.P. (€)
GD0602 GD0601 GD0600	13	1	781039-9	0088381290630	1,15
GD0800C GD0810C	19	1	781206-6	0088381124072	3,85
GD0800C GD0810C	13	1	781203-2	0088381102476	2,60

Llaves de pivotes



Modelos	Unds.	Código	EAN	P.V.P. (€)
115, 125 y 150mm	1	782423-1	0088381572323	1,60
180 - 230 mm	1	197610-3	0088381519007	2,15

Accesorios para cortadores

Grifo completo



Modelos	Unds.	Código	EAN	P.V.P. (€)
4101RH	1	153409-6	0088381201148	17,00

Guía lateral



Modelos	Unds.	Código	EAN	P.V.P. (€)
5604R 5704R 4100KB 4101RH N4105KB 4131	1	164095-8	0088381101080	1,80

Interruptor de seguridad



Modelos	Unds.	Código	EAN	P.V.P. (€)
4101RH	1	P-21571	3240890106254	52,00

Tubo de vinilo



Modelos	Unds.	Código	EAN	P.V.P. (€)
4100NB 4101RH	1	412088-2	0088381538459	3,30

Adaptador carril guía 4100KB



Modelos	Unds.	Código	EAN	P.V.P. (€)
4100KB	1	198673-2	0088381497374	25,00

Accesorios para PW5000CH

Transformador de aislamiento



Descripción	Unds.	Código	EAN	P.V.P. (€)
Transformador que evita derivaciones al usuario	1	P-67016	0088381997546	545,00

Empuñadura



Unds.	Código	EAN	P.V.P. (€)
1	153489-2	0088381193054	1,10

Protector de cabezal



Unds.	Código	EAN	P.V.P. (€)
1	417322-5	0088381156981	7,60



Accesorios para PC5001C

Bolsa de polvo



Unds.	Código	EAN	P.V.P. (€)
1	122853-8	0088381358637	4,90

Set cepillos



Unds.	Código	EAN	P.V.P. (€)
1	194921-7	0088381358675	7,70

Porta llave 5,6



Unds.	Código	EAN	P.V.P. (€)
1	410047-0	0088381123686	0,75



Makita

Casquillo reductor



Ø exterior (mm)	Ø interior (mm)	Unds.	Código	EAN	P.V.P. (€)
22,23	20	10	A-85248	0088381538596	8,75
25,4	20	1	197318-9	0088381234733	10,50



Set de filtros de aire

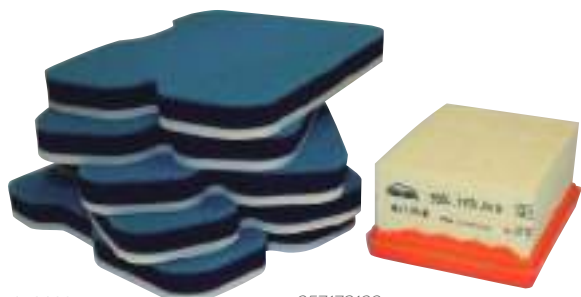

957173190

957173190

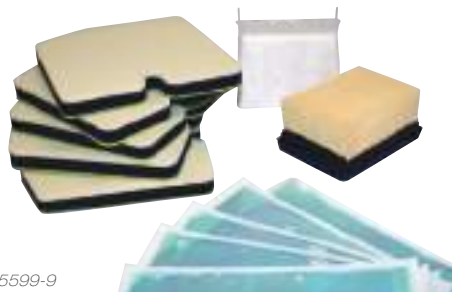

195599-9

Descripción	Modelo	Unds.	Código	EAN	P.V.P. (€)
5 Pre-filtros + filtro	EK7301WS EK8100WS DPC7331 DPC8132	1	957173190	-	19,00
5 Pre-filtros, filtro y cajetín de polvo	EK7651H	1	195599-9	0088381376884	65,00

Aceites



Descripción	Unds.	Código	EAN	P.V.P. (€)
Aceite de motor 4T (220ml) EK7651H	1	195532-1	0088381401937	7,45

Bomba de presión



Modelos	Unds.	Código	EAN	P.V.P. (€)
DPC7331 DPC8132 EK6100 EK7651H 4101RH	1	957802600	4002829128633	406,00

Kit de agua para EK7651

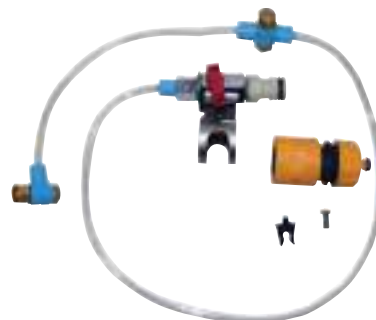

Modelo	Unds.	Código	EAN	P.V.P. (€)
EK7651	1	195534-7	3240890392091	26,00



Pie con ruedas



Modelos	Unds.	Código	EAN	P.V.P. (€)
EK8100WS EK7301WS	1	394114272	-	60,00

Carros de transporte



Tipo	Modelo	Unds.	Código	EAN	P.V.P. (€)
DT4000	EK7651H	1	196354-2	0088381430517	922,00
DT2010	DPC6430 DPC7331 DPC8132 EK7301WS EK8100WS	1	197980-0	-	922,00



Makita

Accesorios para DCC501



140Y25-3 (solo depósito)
191M48-2 (kit completo) 140Y22-9 140Y23-7

127750-3 126738-0



Capaz de cortar tanto en húmedo como en seco cambiando el protector. Cortes en piedra, mampostería, baldosas, hormigón y más.



Descripción	Unds.	Código	EAN	P.V.P. (€)
Kit de agua completo	1	191M48-2	0088381575003	51,00
Tubo de agua completo	1	140Y23-7	-	6,95
Adaptador tanque de agua	1	140Y22-9	-	7,95
Depósito de agua	1	140Y25-3	-	3,65
Cajetín de polvo	1	127750-3	-	13,15
Bolsa de polvo	1	126738-0	0088381589802	6,00

Abrasivo lijas



Lijadoras orbitales

Lijas para BO4556



- Excelente rendimiento de lijado en aplicaciones profesionales.
- Aplicaciones: lijado de madera, hierro y madera pintada. Óxido de aluminio.
- Con grano semi abierto y recubrimiento de resina sobre cola.

Medida (mm)	Grano	Unds.	Código	EAN	P.V.P. (€)
114 x 140	40	10	P-36398	0088381972109	3,85
	60		P-32904	0088381961066	3,35
	80		P-36407	0088381972116	3,35
	100		P-32910	0088381961073	3,10
	120		P-32926	0088381961080	3,10
	150		P-32932	0088381961097	2,85
	180		P-36413	0088381972123	3,10
	240		P-36429	0088381972130	3,10

Lijas para BO4566

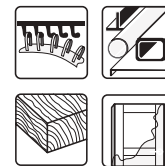
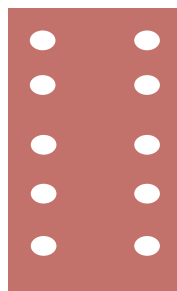

- Lija de grano abierto de corindón con doble recubrimiento de resina.
- Aplicaciones: lijado de maderas secas, pintadas o barnizadas.
- También para metal. Perfecta para ebanistería y carrocería. Orificios de aspiración 5+5.

Medida (mm)	Grano	Unds.	Código	EAN	P.V.P. (€)
100 x 240	40	10	P-42868	0088381970730	6,20
	60		P-42874	0088381970747	6,20
	80		P-42880	0088381970754	5,90
	100		P-42896	0088381970761	5,90
	120		P-42905	0088381970778	5,90
	150		P-42911	0088381970785	5,65
	180		P-42927	0088381970792	5,65
	240		P-42933	0088381970808	5,65

- Especial pintura.
- Excelente rendimiento en aplicaciones profesionales.
- Aplicaciones: lijado de pintura, barniz, madera pintada...



Medida (mm)	Grano	Unds.	Código	EAN	P.V.P. (€)
114 x 140	40	10	P-36516	0088381972222	4,65
	60		P-36522	0088381972239	4,10
	80		P-36538	0088381972246	4,10
	100		P-36544	0088381972253	4,10
	120		P-36550	0088381972260	4,10
	150		P-36566	0088381972277	4,10
	180		P-36572	0088381972284	4,10
	240		P-36588	0088381972291	4,10



Makita

Lijadoras orbitales

Lijas para BO4565

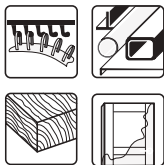

- Excelente rendimiento de lijado en aplicaciones profesionales.
- Aplicaciones: lijado de madera, hierro y madera pintada.
- Óxido de aluminio extra resistente y agarre por velcro. Orificios de aspiración 3+3.

Medida (mm)	Grano	Unds.	Código	EAN	P.V.P. (€)
114 x 102	40	10	P-33087	0088381961240	4,65
	60		P-33093	0088381961257	4,65
	80		P-33102	0088381961264	4,65
	100		P-33118	0088381961271	4,65
	120		P-33124	0088381961288	4,10
	150		P-33130	0088381961295	4,10
	180		P-33146	0088381961301	4,10
	240		P-33152	0088381961318	4,10
	320		P-33168	0088381961325	4,10

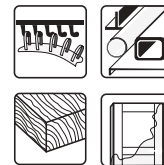

- Para el uso con la mayoría de lijadoras tipo delta con base triangular.
- Aplicaciones: lijado de madera, metal. Ideal para esquinas y lijado de acabado.
- Lija triangular con agarre por velcro y 6 orificios para aspiración.

Medida (mm)	Grano	Unds.	Código	EAN	P.V.P. (€)
93 x 93 x 93	40	10	P-33255	0088381961417	3,85
	60		P-33261	0088381961424	3,85
	80		P-33277	0088381961431	3,85
	100		P-33283	0088381961448	3,60
	120		P-33299	0088381961455	3,60
	150		P-33308	0088381961462	3,60
	180		P-33314	0088381961479	3,60
	240		P-33320	0088381961486	3,60
	320		P-33336	0088381961493	3,60



- Especial pintura. Excelente rendimiento en aplicaciones profesionales. 6 orificios de aspiración.
- Aplicaciones: lijado de pintura, barniz, madera pintada.

Medida (mm)	Grano	Unds.	Código	EAN	P.V.P. (€)
114 x 102	40	10	P-35807	0088381964968	5,40
	60		P-35813	0088381964975	5,15
	80		P-35829	0088381964982	4,90
	100		P-35835	0088381964999	4,90
	120		P-35841	0088381965002	4,90
	150		P-35857	0088381966016	4,90
	180		P-35863	0088381966023	4,90
	240		P-35879	0088381966030	4,90
	320		P-35885	0088381966047	4,90



- Especial pintura. Para el uso con la mayoría de lijadoras tipo delta con base triangular. 6 orificios de aspiración.
- Excelente rendimiento en aplicaciones profesionales.
- Aplicaciones: lijado de pintura, barniz, madera pintada.

Medida (mm)	Grano	Unds.	Código	EAN	P.V.P. (€)
93 x 93 x 93	40	10	P-42684	0088381970556	4,10
	60		P-42690	0088381970563	3,85
	80		P-42709	0088381970570	3,85
	100		P-42715	0088381970587	3,85
	120		P-42721	0088381970594	3,85
	150		P-42737	0088381970600	3,85
	180		P-42743	0088381970617	3,85
	240		P-42759	0088381970624	3,85
	320		P-42765	0088381970631	3,85

Lijadoras orbitales

Lijas para BO3700 / 9036 / BO3711 / DBO380 / DBO381

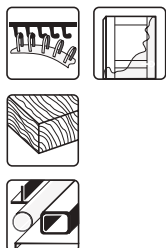

- Excelente rendimiento de lijado en aplicaciones profesionales.
- Aplicaciones: Lijado de madera, hierro y madera pintada. Perforaciones 4+4.

Medida (mm)	Grano	Unds.	Código	EAN	P.V.P. (€)
93 x 185	40	10	P-31871	0088381960038	5,15
	60		P-31887	0088381960045	4,65
	80		P-31893	0088381960052	4,65
	100		P-31902	0088381960069	4,65
	120		P-35891	0088381966054	4,65
	150		P-35900	0088381966061	4,65
	180		P-35916	0088381966078	4,65
	240		P-35922	0088381966085	4,65



- Excelente rendimiento de lijado en aplicaciones profesionales.
- Lija de grano abierto de corindón con doble recubrimiento de resina.
- Ideal para el lijado de maderas secas, pintadas o barnizadas.
- También válida para metal. Perfecta para ebanistería y carrocería.

Medida (mm)	Grano	Unds.	Código	EAN	P.V.P. (€)
93 x 228	40	10	P-36136	0088381966290	3,10
	60		P-32948	0088381961103	2,85
	80		P-36142	0088381966306	2,85
	100		P-32954	0088381961110	2,85
	120		P-36158	0088381966313	2,85
	150		P-32960	0088381961127	2,30



- Excelente rendimiento de lijado en aplicaciones profesionales.
- Lija de grano abierto de corindón con doble recubrimiento de resina.
- Ideal para el lijado de maderas secas, pintadas o barnizadas. También válida para metal.
- Perfecta para ebanistería y carrocería.
- Perforaciones 4+4.

Medida (mm)	Grano	Unds.	Código	EAN	P.V.P. (€)
93 x 228	40	10	P-31837	0088381959995	3,60
	60		P-31843	0088381960007	3,35
	80		P-31859	0088381960014	3,35
	100		P-31865	0088381960021	3,35
	120		P-36011	0088381966177	3,35
	150		P-36027	0088381966184	3,35
	180		P-36033	0088381966191	3,35
	240		P-36049	0088381966207	3,35



Makita

Lijadoras orbitales

Lijas para BO4900V / 9046 / BO4901

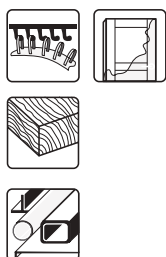

- Excelente rendimiento de lijado en aplicaciones profesionales.
- Lija de grano abierto de corindón con doble recubrimiento de resina.
- Ideal para el lijado de maderas secas, pintadas o barnizadas.
- También válida para metal.
- Perfecta para ebanistería y carrocería.
- Perforaciones 5+5.

Medida (mm)	Grano	Unds.	Código	EAN	P.V.P. (€)
115 x 229	40	10	P-33174	0088381961332	6,45
	60		P-33180	0088381961349	6,20
	80		P-33196	0088381961356	6,20
	100		P-33205	0088381961363	6,20
	120		P-33211	0088381961370	6,20
	180		P-33233	0088381961394	5,90
	240		P-33249	0088381961400	5,90

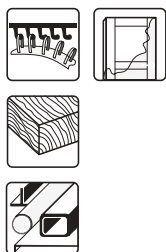

- Lija de alta resistencia. Excelente rendimiento de lijado en aplicaciones profesionales.
- Lija de grano abierto de corindón con doble recubrimiento de resina.
- Ideal para el lijado de maderas secas, pintadas o barnizadas. También válida para metal.
- Perfecta para ebanistería y carrocería.
- Perforaciones 5+5+2+2.

Medida (mm)	Grano	Unds.	Código	EAN	P.V.P. (€)
115 x 229	40	10	P-43022	0088381970891	7,20
	60		P-43038	0088381970907	6,70
	80		P-43044	0088381970914	6,45
	100		P-43050	0088381970921	6,20
	120		P-43066	0088381970938	6,20
	150		P-43072	0088381970945	5,65
	180		P-43088	0088381970952	6,20
	240		P-43094	0088381970969	6,20



- Excelente rendimiento de lijado en aplicaciones profesionales.
- Lija de grano abierto de corindón con doble recubrimiento de resina.
- Ideal para el lijado de maderas secas, pintadas o barnizadas.
- También válida para metal.
- Perfecta para ebanistería y carrocería.
- Perforaciones 5+5+2+2.

Medida (mm)	Grano	Unds.	Código	EAN	P.V.P. (€)
115 x 280	40	10	P-33009	0088381961165	4,40
	60		P-33015	0088381961172	4,10
	80		P-33021	0088381961189	4,10
	100		P-33037	0088381961196	4,10
	120		P-33043	0088381961202	4,10
	150		P-33059	0088381961219	4,10
	180		P-33065	0088381961226	4,10
	240		P-33071	0088381961233	3,85



- Excelente rendimiento de lijado en aplicaciones profesionales.
- Lija de grano abierto de corindón con doble recubrimiento de resina.
- Ideal para el lijado de maderas secas, pintadas o barnizadas.
- También válida para metal.
- Perfecta para ebanistería y carrocería.

Medida (mm)	Grano	Unds.	Código	EAN	P.V.P. (€)
115 x 280	40	10	P-36267	0088381966429	4,10
	60		P-32976	0088381961134	3,85
	80		P-36273	0088381966436	3,85
	100		P-32982	0088381961141	3,85
	120		P-36289	0088381966443	3,85
	150		P-32998	0088381961158	3,10

Lijadoras orbitales

Rollos de lija



- Para uso general. Válido para madera, metal, pintura y barniz.
- Rollo de 5m.
- Ideal para lijadoras orbitales.
- Válido como lija de mano.

Ancho (mm)	Grano	Longitud (m)	Unds.	Código	EAN	P.V.P. (€)
120	40	5	1	P-38102	0088381973816	8,00
	60			P-38118	0088381973823	6,20
	80			P-38124	0088381973830	5,40
	100			P-38130	0088381973847	5,15
	120			P-38146	0088381973854	5,15
	180			P-38152	0088381973861	5,15
	240			P-38168	0088381973878	5,15
	320			P-38174	0088381973885	5,15
	400			P-38180	0088381973892	4,10



- Para uso general. Válido para madera, metal, pintura y barniz.
- Rollo de 50m.
- Ideal para lijadoras orbitales.
- Válido como lija de mano.

Ancho (mm)	Grano	Longitud (m)	Unds.	Código	EAN	P.V.P. (€)
120	40	50	1	P-38196	0088381973908	55,00
	60			P-38205	0088381973915	45,00
	80			P-38211	0088381973922	39,00
	100			P-38227	0088381973939	36,00
	120			P-38233	0088381973946	36,00
	180			P-38249	0088381973953	36,00
	240			P-38255	0088381973960	36,00
	320			P-38261	0088381973977	36,00
	400			P-38277	0088381973984	36,00

Bases para lijadoras orbitales



158324-9



158326-5



158325-7



140441-9

Modelo	Tipo	Medida	Unds.	Código	EAN	P.V.P. (€)
BO4556 BO4565 BO4566	Cuadrada Goma *	112 x 102	1	158324-9	0088381413596	3,00
	Triangular Velcro	112 x 190	1	158325-7	3240890999597	8,00
	Rectangular Velcro	100 x 164	1	158326-5	3240890999580	7,00
BO3700 BO3711	Goma	93 x 185	1	140441-9	-	4,20
	Velcro	93 x 185	1	194930-6	0088381355759	14,40 **
BO4900V BO4901	Goma	115 x 229	1	193523-6	0088381164719	15,00
	Velcro	115 x 229	1	193521-0	0088381164702	28,00
9046	Velcro	115 x 229	1	162172-0	3240890063304	37,00

* Para cambiar la base de goma de BO4556 a base de velcro triangular o rectangular es necesario utilizar base 450068-0.
** Esta base se considera accesorios.

Lijadoras rotorbitales

Lijas para BO5040 / BO5041 / DB0180

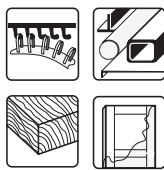

- Lija de grano semiabierto de óxido de aluminio, con recubrimiento de resinas fenólicas.
- Ideal para trabajos en madera, plástico, metal en planchas, maderas barnizadas y metales pintados.
- Perforaciones 8.

Ø (mm)	Grano	Unds.	Código	EAN	P.V.P. (€)
125	40	10	P-43533	0088381971409	5,15
	60		P-43549	0088381971416	4,90
	80		P-43555	0088381971423	4,65
	100		P-43561	0088381971430	4,65
	120		P-43577	0088381971447	4,65
	180		P-43583	0088381971454	4,65
	240		P-43599	0088381971461	4,65
	320		P-43608	0088381971478	4,40
	400		P-43614	0088381971485	4,40

Lijas para BO6030 / BO6050



- Lija de grano semiabierto de óxido de aluminio, con recubrimiento de resinas fenólicas.
- Ideal para trabajos en madera, plástico, metal en planchas, maderas barnizadas y metales pintados.
- Perforaciones 8.

Ø (mm)	Grano	Unds.	Código	EAN	P.V.P. (€)
150	40	10	P-31918	0088381960076	7,20
	60		P-31924	0088381960083	6,95
	80		P-31930	0088381960090	6,70
	100		P-31946	0088381960106	6,45
	120		P-31952	0088381960113	6,45
	150		P-31968	0088381960120	6,45
	180		P-31974	0088381960137	6,45
	220		P-31980	0088381960144	6,45
	240		P-31996	0088381960151	6,45
	320		P-32007	0088381960168	6,45
	400		P-32013	0088381960175	6,45

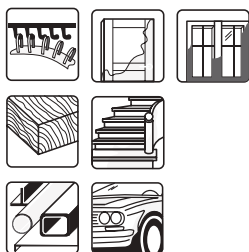

- Especial pintura.
- Excelente rendimiento en trabajos de automoción.
- Recubrimiento antiestático que previene atascos en la lija para un acabado más fino.
- Perforaciones 8.

Ø (mm)	Grano	Unds.	Código	EAN	P.V.P. (€)
125	40	10	P-33342	0088381961509	4,65
	60		P-33358	0088381961516	4,40
	80		P-33364	0088381961523	4,10
	100		P-33370	0088381961530	4,10
	120		P-33386	0088381961547	4,10
	180		P-33392	0088381961554	4,10
	240		P-33401	0088381961561	4,10
	320		P-33417	0088381961578	4,10
	400		P-33423	0088381961585	4,10

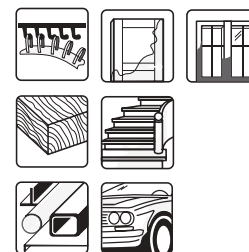
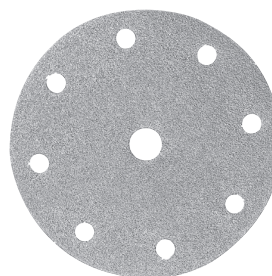

- Especial pintura.
- Excelente rendimiento en trabajos de automoción.
- Recubrimiento antiestático que previene atascos en la lija para un acabado más fino.
- Perforaciones 8.

Ø (mm)	Grano	Unds.	Código	EAN	P.V.P. (€)
150	40	10	P-37839	0088381973540	6,95
	60		P-37845	0088381973557	6,45
	80		P-37851	0088381973564	6,20
	100		P-37867	0088381973571	5,90
	120		P-37873	0088381973588	5,90
	150		P-37889	0088381973595	5,90
	180		P-37895	0088381973601	5,90
	220		P-37904	0088381973618	5,90
	240		P-37910	0088381973625	5,90
	320		P-37926	0088381973632	5,90
	400		P-37932	0088381973649	5,90

Lijadoras roborbitales y de disco

Cajas de discos de velcro perforados de 150mm

- Gama de lijas de óxido de aluminio para lijadoras roborbitales de 150mm.
- Paquetes de 50 y 100 unidades.
- Ideales para usuarios con gran consumo de lijas.
- Perfectas para el acabado en fibra de vidrio, madera, metal y chapa de automóvil.
- Perforaciones 8+6.



Ø (mm)	Grano	Unds.	Código	EAN	P.V.P. (€)
150	40	50	B-39300	0088381434041	29,00
	60		B-39316	0088381434058	27,00
	80		B-39322	0088381434065	48,00
	100	100	B-39338	0088381434072	45,00
	120		B-39344	0088381434089	43,00
	240		B-39350	0088381434096	42,00
	320		B-39366	0088381434102	42,00
	360		B-39372	0088381434119	42,00
	400		B-39388	0088381434126	42,00
	500		B-39394	0088381434133	42,00
	600	B-39403	0088381434140	42,00	
	800	B-39419	0088381434157	42,00	
	1.000	B-39425	0088381434164	42,00	

Lijas para jirafa DSL800 de 225mm

- Discos especiales para trabajos en tabiquería seca.
- Grano cerámico con resina.
- Recubrimiento especial, previene que se emboce y evita el desgaste.
- Más durabilidad que un disco abrasivo.



Ø (mm)	Grano	Unds.	Código	EAN	P.V.P. (€)
225	40	25	B-68389	0088381545891	32,00
	80		B-68395	0088381545907	31,00
	120		B-68404	0088381545914	27,00
	180		B-68410	0088381545921	27,00
	320		B-68426	0088381545938	27,00

Lijas de discos 115mm / 125mm / 180mm

- Discos de fibra excelentes para quitar barnices y pinturas en madera y metal, así como repasos en soldaduras.



Ø (mm)	Grano	Unds.	Código	EAN	P.V.P. (€)
115	24	5	P-00860	0088381918787	4,20
	40		P-00882	0088381918800	5,50
	60		P-00907	0088381918824	5,50
	80		P-00913	0088381918831	5,50
	120		P-00935	0088381918848	5,80
125	24		P-00957	0088381922203	5,00
	40		P-00979	0088381922227	6,30
	60		P-00985	0088381922234	6,30
	80		P-00991	0088381922241	6,55
	100		P-01002	0088381922258	6,85
180	120		P-01018	0088381922265	6,85
	24		P-01030	0088381918879	7,90
	40		P-01052	0088381918893	8,15
	60		P-01074	0088381918916	8,15
	80		P-01080	0088381918923	8,15
	100	P-01096	0088381918930	7,60	
	120	P-01105	0088381918947	7,60	

Lijas para lijadoras de disco 180mm

- Lija de óxido de aluminio de grano abierto con recubrimiento de resina y pegamento con base de látex.
- Excelente rendimiento en trabajos de automoción.
- Perfecta para los trabajos en maderas sin tratar, maderas barnizadas, carrocería.
- Especial para el lijado de pintura.



Ø (mm)	Grano	Unds.	Código	EAN	P.V.P. (€)
180	40	10	P-33439	0088381961592	10,30
	60		P-38037	0088381973748	8,50
	80		P-33445	0088381961608	8,00
	100		P-38043	0088381973755	7,70
	120		P-33451	0088381961615	7,70
	240		P-38059	0088381973762	7,70
	320	P-38065	0088381973779	7,70	

Platos de velcro para lijadoras / pulidoras de disco



197925-8

PO6000C



Platos de caucho para lijadoras / pulidoras de disco



Descripción	Ø (mm)	Unds.	Código	EAN	P.V.P. (€)
Necesita tuerca	115	1	743015-1	0088381102094	8,85
	120		743025-8	0088381101295	4,65
	125		743016-9	0088381109017	9,55
	170		743008-8	0088381109055	23,00
5/8"	170		743012-7	0088381101233	15,45

Tuerca para platos de caucho



Descripción	Unds.	Código	EAN	P.V.P. (€)
M14	1	224515-5	0088381116190	5,15

M14

743060-6



DSL800

199939-3



Descripción	Ø (mm)	Unds.	Código	EAN	P.V.P. (€)
PO6000C	100	1	197925-8	00883811468367	58,00
	125		197922-4	00883811468343	57,00
	150		197928-2	00883811468381	57,00
M14	115	1	743060-6	0088381156967	15,45
	117		P-21777	0088381948876	12,35
	165		743053-3	0088381146104	19,55
DSL800	Blando	210	199939-3	0088381546157	54,00
	Medio		199940-8	0088381546164	61,00
	Duro		199938-5	0088381546140	59,00



Lijas para lijadoras de banda

- Lija de óxido de aluminio con grano cerrado y doble recubrimiento de resina sobre base de tela.
- Producto de gran resistencia diseñado especialmente para lijadoras de banda.
- Válidas para todo tipo de maderas y metales.



Modelos	Medida (mm)	Grano	Unds.	Código	EAN	P.V.P. (€)
9910 9911	76 x 457	40	5	P-37091	0088381972802	9,25
		60		P-37100	0088381972819	9,00
		80		P-37116	0088381972826	9,00
		100		P-37122	0088381972833	9,00
		120		P-37138	0088381972840	9,00
		150		P-37144	0088381972857	9,00
		240		P-37150	0088381972864	9,00



Modelo	Medida (mm)	Grano	Unds.	Código	EAN	P.V.P. (€)
9903	76 x 533	40	5	P-37172	0088381972888	9,80
		60		P-37188	0088381972895	9,25
		80		P-37194	0088381972901	8,75
		100		P-37203	0088381972918	8,50
		120		P-37219	0088381972925	8,50
		150		P-37225	0088381972932	8,50
		240		P-37231	0088381972949	8,50



Modelos	Medida (mm)	Grano	Unds.	Código	EAN	P.V.P. (€)
9920 9924DB	76 x 610	40	5	P-37312	0088381973021	10,80
		60		P-37328	0088381973038	10,30
		80		P-37334	0088381973045	9,80
		100		P-37340	0088381973052	9,00
		120		P-37356	0088381973069	9,00
		150		P-37362	0088381973076	9,00
		240		P-37378	0088381973083	9,00



Modelos	Medida (mm)	Grano	Unds.	Código	EAN	P.V.P. (€)
9402 9403 9404	100 x 610	40	5	P-36887	0088381972598	12,90
		60		P-36893	0088381972604	11,85
		80		P-36902	0088381972611	11,85
		100		P-36918	0088381972628	11,85
		120		P-36924	0088381972635	11,85
		150		P-36930	0088381972642	11,85
		240		P-36946	0088381972659	11,85

Placas grafitadas



Modelo	Unds.	Código	EAN	P.V.P. (€)
9924DB	1	423036-6	008838116398	2,20
9402		423029-3	008838116367	2,80
9403		421648-9	0088381148191	3,50
9404		193201-8	0088381157056	7,30
9903		423315-2	0088381154291	2,35
9920		423316-0	0088381154307	2,85

Placas de corcho

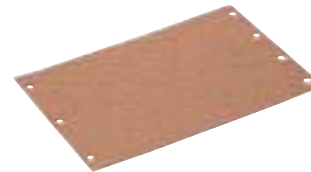

Modelo	Unds.	Código	EAN	P.V.P. (€)
9404	1	193202-6	0088381157063	4,90
9903		423312-8	0088381154321	2,05
9402		421093-8	0088381123839	4,10
9924DB		423035-8	0088381152532	3,85
9403		421646-3	0088381148177	2,60
9901		423149-3	0088381126397	2,60
9920		423313-6	0088381154338	2,60

Placas metal



Modelo	Unds.	Código	EAN	P.V.P. (€)
9402	1	342328-3	008838116244	2,85
9924DB		341705-6	008838116268	3,35
9404		151751-9	0088381154284	8,00
9902 9903		151749-6	0088381154246	5,15
9920		151750-1	0088381154277	5,15
9403 (metal + corcho)		150980-1	0088381148153	5,15
9903		344620-3	0088381148160	2,15
9910 9911		344586-7	0088381146791	2,60

Lijas de banda de alta calidad para 9032

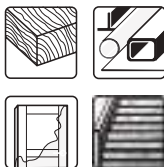
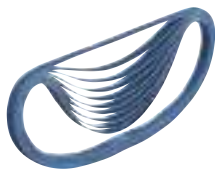

10uds

Modelo	Medida (mm)	Grano	Unds.	Código	EAN	P.V.P. (€)
9032	6x533	80	10	A-34534	0088381164450	20,10
		100		A-34540	0088381164467	19,05
		120		A-34556	0088381164474	18,00
	9x533	40		A-34447	0088381164382	21,00
		60		A-34453	0088381164399	21,00
		80		A-34469	0088381164405	19,05
		100		A-34475	0088381164412	16,50
		120		A-34481	0088381164429	16,50
		13x533		40	A-34562	0088381164481
	60			A-34578	0088381164498	23,00
	80			A-34584	0088381164504	22,00
	100			A-34590	0088381164511	22,00
	120	A-34609	0088381164528	19,05		

25uds

Modelo	Medida (mm)	Grano	Unds.	Código	EAN	P.V.P. (€)
9032	6x533	60	25	P-39394	0088381967266	30,00
	6x533	100		P-39419	0088381967280	30,00
	6x533	120		P-39425	0088381967297	30,00

Lijas de banda de alta calidad para 9031



Modelo	Medida (mm)	Grano	Unds.	Código	EAN	P.V.P. (€)
9031	30 x 533	40	5	P-36675	0088381972383	4,90
	30 x 533	60		P-36681	0088381972390	4,40
	30 x 533	80		P-36697	0088381972406	4,40
	30 x 533	100		P-36706	0088381972413	4,40
	30 x 533	120		P-36712	0088381972420	4,40
	30 x 533	150		P-36728	0088381972437	4,40
	30 x 533	240		P-36734	0088381972444	4,40

Lijas de banda para LB1200F



Grano	Dimensiones (mm)	Unds.	Código	EAN	P.V.P. (€)
80	20 x 2240	1	B-42581	0088381440738	13,40
120	20 x 2240		B-42597	0088381440745	13,40

Lijas de banda estándar para 9032

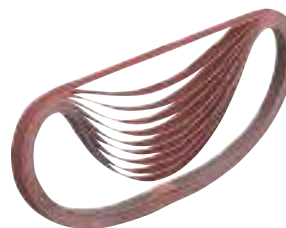

5uds

Modelo	Medida (mm)	Grano	Unds.	Código	EAN	P.V.P. (€)
9032	6x533	40	5	P-43181	0088381971058	5,40
		60		P-43197	0088381971065	5,40
		80		P-43206	0088381971072	5,15
		100		P-43212	0088381971089	5,15
		120		P-43228	0088381971096	5,15
		150		P-43234	0088381971102	5,15
		240		P-43240	0088381971119	5,15
		9x533		40	P-43256	0088381971126
	60			P-43262	0088381971133	6,20
	80			P-43278	0088381971140	5,90
	100			P-43284	0088381971157	5,90
	120			P-43290	0088381971164	5,90
	150			P-43309	0088381971171	5,90
	240			P-43315	0088381971188	5,90
	13x533			40	P-43321	0088381971195
		60		P-43337	0088381971201	7,70
		80		P-43343	0088381971218	7,45
		100		P-43359	0088381971225	7,20
		120		P-43365	0088381971232	7,20
		150		P-43371	0088381971249	7,45
		240		P-43387	0088381971256	7,45

Lija de banda especial cristal para 9031



Modelo	Medida (mm)	Grano	Unds.	Código	EAN	P.V.P. (€)
9031	30 x 533	40	5	P-01395	0088381922302	11,35
	30 x 533	60		P-01404	0088381922319	11,35
	30 x 533	80		P-01199	0088381913928	10,30
	30 x 533	100		P-01208	0088381913935	10,30
	30 x 533	120		P-01214	0088381913942	10,30
	30 x 533	150		P-01220	0088381913959	10,30
	30 x 533	180		P-01236	0088381913966	10,30

Accesorios de pulido para PV301 y DPV300



743126-2

743124-6

Descripción	Grano	Unds.	Código	EAN	P.V.P. (€)
Discos de lija	A60	25	E-07412	0088381574044	44,00
	A80		E-07428	0088381574051	44,00
	A120		E-07434	0088381574068	44,00
	Z60		E-07440	0088381574075	44,00
	Z80		E-07456	0088381574082	44,00
Discos abrasivos para superficie	Grueso	25	E-07462	0088381574099	81,00
	Medio		E-07478	0088381574105	81,00
	Fino		E-07484	0088381574112	81,00
	Medio		E-07490	0088381574129	71,00
	Fino		E-07509	0088381574136	71,00
	Muy fino		E-07515	0088381574143	71,00
Adaptador	-	1	743126-2	-	5,25
Plato	-	1	743124-6	0088381587853	13,40



Adaptador de boina doble



Descripción	Unds.	Código	EAN	P.V.P. (€)
Adaptador boina doble	1	D-56960	0088381457620	2,15

Plato velcro



191N90-9

191N91-7

191N92-5

743125-4

Descripción	Grano	Unds.	Código	EAN	P.V.P. (€)
Esponja de velcro (basto)	80	25	191N90-9	0088381577045	9,55
Esponja de velcro (medio)	80		191N91-7	0088381577052	11,85
Boina de lana con velcro	80		191N92-5	0088381577069	11,85
Plato de velcro	80		743125-4	0088381587860	35,00

Modelo	Descripción	Ø (mm)	Unds.	Código	EAN	P.V.P. (€)
BO5030 BO5031 BO5040 BO5041	Blando (lijado general)	123	1	743081-8	0088381350044	30,00
BO6040 BO6030	Duro (lijado grueso)	150		196685-9	0088381438957	24,00
	Blando (lijado general)	150		196684-1	0088381438940	28,00
	Súper blando (lijado fino)	150		196686-7	0088381438964	27,00
BO6050J	Duro (lijado grueso)	150		197315-5	0088381461955	49,00
	Blando (lijado general)	150		197314-7	0088381461948	45,00
	Súper blando (lijado fino)	150		197316-3	0088381461962	49,00
	Pulido	130		197317-1	0088381461979	45,00

Boinas de lana doble



Ø (mm)	Modelos	Unds.	Código	EAN	P.V.P. (€)
230	9237CB	1	D-70873	0088381557771	17,45

Boinas de lana con velcro. Pulidos alto brillo



Ø (mm)	Unds.	Código	EAN	P.V.P. (€)
100	1	197896-9	0088381468305	17,00
125		197897-7	0088381468329	14,95
150		199424-6	0088381534567	26,00
150		794560-9	0088381149365	22,00
180		192629-7	0088381140690	19,55

Boinas de lana



794176-0

Ø (mm)	Tipo	Unds.	Código	EAN	P.V.P. (€)
100	Lana	1	794173-6	0088381103848	12,35
180	Cordero		794176-0	0088381117159	22,00

Fieltro (con velcro)



Ø (mm)	Tipo	Unds.	Código	EAN	P.V.P. (€)
100	Velcro	1	197895-1	0088381468282	27,00
125	Velcro		196152-4	0088381413572	24,00
150	Velcro		794618-4	0088381157841	18,50



Esponjas de velcro



D-70786

D-70792

P-21733

Ø (mm)	Tipo		Unds.	Código	EAN	P.V.P. (€)
100	-	Lisa	1	197893-5	0088381468244	17,50
125	-	Lisa		794558-6	0088381149358	24,00
150	-	Lisa		197894-3	0088381468268	21,00
190	Basto	Lisa		D-70786	0088381556071	17,45
190	Medio	Lisa		D-70792	0088381556088	17,45
150	Basto	Lisa		P-21727	0088381948821	14,40
150	Fino	Lisa	P-21733	0088381948838	10,05	



100	Basto	Lisa	1	D-62505	0088381498142	4,60
125	Basto	Lisa		D-62511	0088381498159	6,50
150	Basto	Lisa		D-62527	0088381498166	7,65



100	Medio	Lisa	1	D-62533	0088381498173	4,60
125	Medio	Lisa		D-62549	0088381498180	6,50
150	Medio	Lisa		D-62555	0088381498197	7,65



100	Fino	Lisa	1	D-62561	0088381498203	4,60
125	Fino	Lisa		D-62577	0088381498210	6,50
150	Fino	Lisa		D-62583	0088381498227	7,65



100	Basto	Ondulada	1	D-62599	0088381498234	4,60
125	Basto	Ondulada		D-62608	0088381498241	6,50
150	Basto	Ondulada		D-62614	0088381498258	7,65



100	Medio	Ondulada	1	D-62620	0088381498265	4,60
125	Medio	Ondulada		D-62636	0088381498272	6,50
150	Medio	Ondulada		D-62642	0088381498289	7,65



100	Fino	Ondulada	1	D-62658	0088381498296	4,60
125	Fino	Ondulada		D-62664	0088381498302	6,50
150	Fino	Ondulada		D-62670	0088381498319	7,65

Placas perforadoras



Modelo	Tipo	Unds.	Código	EAN	P.V.P. (€)
BO4553	Metálica	1	413094-0	0088381201025	1,30
BO4556	Plástico	1	450066-4	0088381346085	0,90
BO3711	Metálica	1	192989-7	0088381151160	7,20
9046 BO4900V BO4901	Metálica	1	192523-3	0088381132282	21,00



Soporte + Bolsa de papel



Descripción	Modelo	Unds.	Código	EAN	P.V.P. (€)
Soporte + Bolsa	BO4900V BO5020 BO5021 BO6030 BO9046	1	193294-5	0088381160247	12,35

Bolsas de tela



Descripción	Modelo	Unds.	Código	EAN	P.V.P. (€)
Tela roja (con adaptador)	9046	1	152456-4	0088381133548	20,10
Tela roja (con adaptador)	BO3700 BO3711	1	151780-2	0088381156929	2,45
Tela roja (sin adaptador) para 151518-5	BO4901 BO4900V BO6030	1	151517-7*	0088381150859	8,25
Tela (con adaptador)	BO4556 BO4565 BO4566	1	135222-4	0088381435918	4,60

* Válidas para cajón recoge polvo.

Bolsas de papel y nylon



Descripción	Modelo	Unds.	Código	EAN	P.V.P. (€)
Papel (11cm)	BO3711 BO4556 BO4565 BO4566 BO5030 BO5031 BO5040 BO5041	5	194746-9*	0088381352017	5,15
Papel (15cm)	BO4553	5	193712-3	0088381181730	6,25
Papel (larga)	BO4900V BO6030 9046	5	193293-7	0088381160254	7,60
Nylon (11cm)	BO4556 BO4565 BO4566	1	168557-8*	3240890313324	2,50

Cajon recoge polvo



Descripción	Modelo	Unds.	Código	EAN	P.V.P. (€)
Con adaptador y bolsa de papel pequeña	BO5030 BO5031 BO5040 BO5041	1	135246-0	0088381403528	4,65
Con adaptador y bolsa de nylon	BO3711 DBO180	1	135327-0	0088381365611	6,20
Sin adaptador y sin bolsa	DBO380 DBO381	1	450770-5	-	2,40



Extensión para DSL800



Descripción	Unds.	Código	EAN	P.V.P. (€)
Set mango extensor	1	199937-7	0088381549370	175,00

Empuñaduras

1

2



Modelo	Tipo	Descripción	Unds.	Código	EAN	P.V.P. (€)
GV7000C PV7000C	1	Empuñadura	1	152491-2	0088381131605	2,35
9227CB	2	Asa	1	416348-4	0088381201193	10,40
PO6000C	1	Empuñadura	1	198043-5	0088381473033	8,75
DPO600	1	Empuñadura	1	144163-3	0088381523769	3,25

Soporte de lija para 9032



Descripción	Modelo	Unds.	Código	EAN	P.V.P. (€)
Soporte de lija 6 mm	9032	1	125157-7	0088381164009	59,00
Soporte de lija 9 mm		1	125158-5	0088381164016	33,00
Soporte de lija 13 mm		1	125159-3	0088381164023	80,00

Protectores de plástico



Modelo	Descripción	Unds.	Código	EAN	P.V.P. (€)
9565CLR	Protector de plástico	1	417322-5	0088381156981	7,60
9227CB		1	417671-0	0088381169424	16,85
9237C		1	455291-2	3240890404916	8,80
SA5040C		1	453378-4	0088381538480	9,75
SA7000C		1	418529-6	0088381191975	3,00

Protector de polvo 9237C



Modelo	Descripción	Unds.	Código	EAN	P.V.P. (€)
9237C	Evita la entrada de partículas gruesas en el motor	1	455288-1	3240890404909	2,85

Accesorios para pulidoras



Modelo	Tipo	Descripción	Unds.	Código	EAN	P.V.P. (€)
9227CB PV7000C SA7000C	A	Centrador para accesorios de velcro	1	262542-4	0088381142915	2,20

Soporte vertical



Modelos	Unds.	Código	EAN	P.V.P. (€)
9032	1	193618-5	0088381173988	33,00

Mordazas de apriete



Modelos	Unds.	Código	EAN	P.V.P. (€)
9910 9911	2	192694-6	0088381145626	40,00

Nivelador



Modelos	Unds.	Código	EAN	P.V.P. (€)
9902 9903	1	193070-7	0088381154369	94,00
9404	1	193072-3	0088381154383	95,00

Soporte



Modelos	Unds.	Código	EAN	P.V.P. (€)
9402 9401	1	342332-2	0088381116350	3,85

Bolsa recoge polvo para lijadoras de banda



Modelos	Unds.	Código	EAN	P.V.P. (€)
9402	1	122297-2	0088381116299	10,85
9403	1	122562-9	0088381148184	13,20
9404 9920	1	122591-2	0088381154239	11,85
9911	1	122548-3	0088381146784	5,45
9924DB	1	122296-4	0088381116282	13,15

Soporte con guía lateral



Modelos	Unds.	Código	EAN	P.V.P. (€)
9903 - 9920 - 9404	1	193055-3	0088381151955	81,00
9924DB	1	STEX122299	0088381116336	105,00

Desviador de aire para 9402



Modelos	Unds.	Código	EAN	P.V.P. (€)
9402	1	503174	-	13,90

Multiherramienta

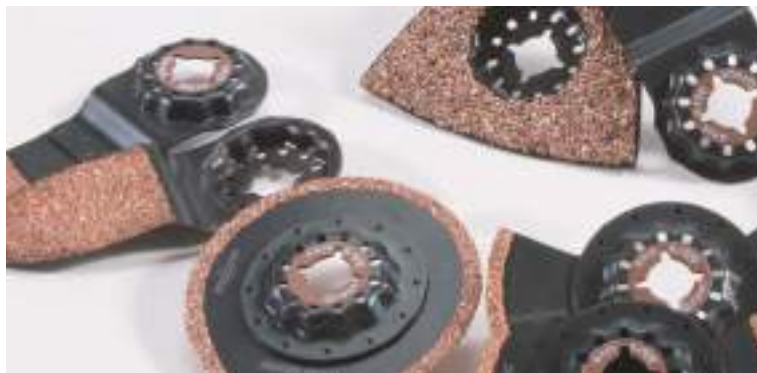

Accesorios multiherrameinta - Gama Starlock

STARLOCK

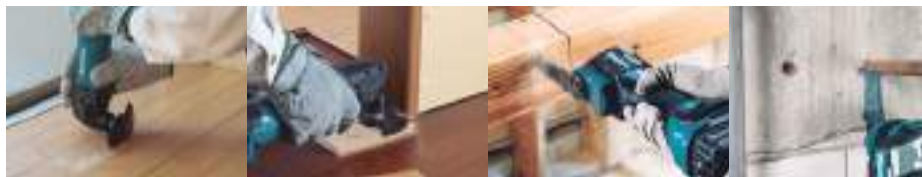

	Nombre	Medida (mm)	Dientes por pulgada	Material	Diente curvo	Madera					Metal			
						Madera	Contrachapado	Agglomerado	Laminado	Tablero de escayola	Metal no ferroso	Chapa metálica	Inoxidable	Metal blando
	TMA064	85	18	BiM		✓	✓	✓	✓	✓	✓	✓		✓
	TMA046	100	15	BiM		✓	✓	✓	✓	✓	✓			✓
	TMA049	85	18	HCS		✓	✓	✓	✓					
	TMA045	85	18	BiM		✓	✓	✓	✓	✓	✓	✓		✓
	TMA048	65 x 40	20	BiM	✓	✓	✓	✓	✓	✓	✓	✓		✓
	TMA052	65 x 40	20	HCS	✓	✓	✓	✓						
	TMA047	32 x 50	20	BiM	✓	✓	✓	✓	✓	✓	✓	✓		✓
	TMA051	32 x 50	18	HCS	✓	✓	✓	✓	✓					
	TMA055	65 x 40	14	BiM	✓	✓	✓	✓	✓					
	TMA056	65 x 40	14	HCS	✓	✓	✓							
	TMA053	32 x 50	14	BiM	✓	✓	✓	✓	✓					
	TMA050	24 x 50	18	HCS		✓	✓	✓	✓					
	TMA058	20 x 30	20	BiM		✓	✓	✓	✓	✓	✓	✓		✓
	TMA061	32 x 40	23	TC / HM		✓	✓	✓	✓	✓	✓	✓	✓	✓
	TMA059	32 x 50	20	BiM		✓	✓	✓	✓	✓	✓	✓		✓
	TMA057	10 x 30	20	HCS		✓	✓	✓	✓	✓	✓	✓		✓
	TMA060	20 x 40	23	TC / HM		✓	✓	✓	✓	✓	✓	✓	✓	✓
	TMA054	32 x 50	14	HCS	✓	✓	✓							
	TMA065	52 x 26	-	HCS										
	TMA066	52 x 40	-	HCS										
	TMA063	100	-	BiM										
	TMA067	28 x 40	-	HCS										
	TMA068	11 x 24	-	HCS										
	TMA075	32 x 30	-	TC # 50		✓				✓				
	TMA076	32 x 50	-	TC # 40		✓	✓							
	TMA077	32 x 50	-	TC # 100		✓	✓							
	TMA074	70	-	TC # 40						✓				
	TMA069	85	-	TC # 30						✓				
	TMA070	85	-	TC # 40						✓				
	TMA071	70	-	TC # 50						✓				
	TMA072	85	-	TC # 40						✓				
	TMA073	78	-	TC # 20		✓								



Multimaterial						Abrasivo		
Epoxy	Fibra de vidrio	Linóleo	Adhesivos	Material de aislamiento	Material de junta suave	Ladrillo blando	Azulejos	Adhesivos y mortertos
✓	✓							
✓	✓							
✓								
✓	✓							
✓	✓							
✓	✓							
✓	✓							
✓	✓							
✓	✓							
✓	✓							
✓	✓							
✓	✓							
✓	✓							
✓	✓							
✓	✓							
			✓					
			✓					
		✓	✓	✓				
					✓			
		✓	✓	✓				
✓	✓					✓	✓	✓
✓	✓					✓		✓
✓	✓					✓	✓	✓
✓	✓					✓	✓	✓
✓	✓					✓	✓	✓
✓	✓					✓	✓	✓
✓								✓



STARLOCK MAX



	Nombre	Medida (mm)	Dientes por pulgada	Material cuchilla	Diente Curvo	Madera					Metal			
						Madera	Contra-chapado	Aglome-rado	Laminado	Tablero de escayola	Metal no ferroso	Chapa metálica	Inoxidable	Metal blando
	MAM003	100	15	BiM		✓	✓	✓	✓		✓			✓
	MAM011	68	-	Diamante						✓				
	MAM009	68	-	TC # 50						✓				
	MAM010	68	-	TC # 30						✓				
	MAM014	100	-	TC # 40		✓	✓			✓	✓			✓
	MAM005	32	23	TC		✓	✓	✓	✓	✓	✓	✓	✓	✓
	MAM006	32	20	TC	✓	✓	✓	✓	✓	✓	✓	✓	✓	✓
	MAM004	32	18	HCS	✓	✓	✓	✓	✓					
	MAM001	32	20	BiM	✓	✓	✓	✓	✓	✓	✓	✓		✓
	MAM002	52	18	BiM	✓	✓	✓	✓	✓	✓	✓			✓
	MAM008	32	-	HCS										
	MAM007	32	-	HCS										
	MAM015	116	-	TC # 20		✓	✓	✓						
	MAM017	116	-	TC # 60		✓	✓	✓						



Multimaterial						Abrasivo		
Epoxy	Fibra de vidrio	Linóleo	Adhesivos	Material de aislamiento	Material de junta suave	Ladrillo blando	Azulejos	Adhesivos y morteros
✓								
✓	✓					✓	✓	✓
✓	✓					✓	✓	✓
✓	✓					✓	✓	✓
✓	✓					✓		✓
✓	✓					✓		
✓	✓					✓		
✓	✓							
✓	✓							
				✓	✓			
					✓			
	✓							✓



Accesorios de corte



Cuchilla de corte segmentada 85 STARLOCK

TMA064



- Metales no ferrosos, FRP, PVC.
- Adecuado para esquinas.
- Corte por inmersión en placas de yeso o de fibra de cemento.
- Realizar cajeados en fibra de vidrio (PRFV) / epoxy

Ø (mm)	Material / Indicado para	Unds.	Código	EAN	P.V.P. (€)
85	BiM - TIN / Multimaterial	1	B-64973	0088381536479	23,00

Cuchilla de corte segmentada 100 STARLOCK

TMA046



- Madera y metal.
- Indicado para cortes profundos a ras.
- Marcos de puertas.
- Parquet / suelo laminado.

Ø (mm)	Material / Indicado para	Unds.	Código	EAN	P.V.P. (€)
100	BiM / Madera y Metal	1	B-64808	0088381536301	24,00

Cuchilla de corte segmentada 85 STARLOCK

TMA049



- Cortes de inmersión en madera sólida.
- Indicado para cortes a ras.
- Tubo de PVC.

Ø (mm)	Material / Indicado para	Unds.	Código	EAN	P.V.P. (€)
85	HCS / Madera	1	B-64836	0088381536332	14,40

Cuchilla de corte segmentada 85 STARLOCK

TMA045



- Madera y metal.
- Indicado para cortes profundos a ras.
- Marcos de puertas.
- Parquet / suelo laminado.

Ø (mm)	Material / Indicado para	Unds.	Código	EAN	P.V.P. (€)
85	BiM / Madera y Metal	1	B-64799	0088381536295	17,00

Accesorios de corte de inmersión



Cuchilla de inmersión 65 STARLOCK

TMA048



- Madera y clavos.
- Marcos de puerta.
- Cortes por inmersión en paneles laminados.

Tamaño (mm)	Material / Indicado para	Unds.	Código	EAN	P.V.P. (€)
65 x 40	BiM / Madera y Metal	1	B-64820	0088381536325	18,00

Cuchilla de inmersión 65 STARLOCK

TMA052



- Madera y metal.
- Indicado para corte a ras.
- Parquet / suelo laminado.
- Cortes de inmersión en madera.

Tamaño (mm)	Material / Indicado para	Unds.	Código	EAN	P.V.P. (€)
65 x 40	HCS / Madera	1	B-64864	0088381536363	13,40

Cuchilla de inmersión 32 STARLOCK

TMA047



- Madera y metal.
- Adecuado para corte por inmersión precisa.
- Corte por inmersión en madera dura.

Tamaño (mm)	Material / Indicado para	Unds.	Código	EAN	P.V.P. (€)
32 x 50	BiM / Madera y Metal	1	B-64814	0088381536318	12,90
32 x 50	BiM / Madera y Metal (20 Unds.)	20	B-64814-20	0088381541213	211,00

Cuchilla de inmersión 32 STARLOCK

TMA051



- Cajeados en muebles.
- Cortes profundos en madera blanda.
- Cortes de inmersión en madera blanda.

Tamaño (mm)	Material / Indicado para	Unds.	Código	EAN	P.V.P. (€)
32 x 50	HCS / Madera	1	B-64858	0088381536356	11,35
32 x 50	HCS / Madera (20 Unds.)	20	B-64858-20	0088381541220	130,00

Accesorios de corte de inmersión

Cuchilla de inmersión 65



TMA055



- Cajeados en muebles.
- Cortes al ras.
- Corte de inmersión en paneles laminados o madera dura.

Tamaño (mm)	Material / Indicado para	Unds.	Código	EAN	P.V.P. (€)
65 x 40	BiM / Madera	1	B-64892	0088381536394	17,50

Cuchilla de inmersión 65



TMA056



- Cajeados en muebles.
- Cortes al ras.
- Corte de inmersión en paneles laminados o madera.

Tamaño (mm)	Material / Indicado para	Unds.	Código	EAN	P.V.P. (€)
65 x 40	HCS / Madera	1	B-64901	0088381536400	14,40

Cuchilla de inmersión 32



TMA053



- Madera dura.
- Cajeados en muebles.
- Cortes de inmersión en madera dura y paneles laminados.

Tamaño (mm)	Material / Indicado para	Unds.	Código	EAN	P.V.P. (€)
32 x 50	BiM / Madera	1	B-64870	0088381536370	11,60
32 X 50	BiM / Madera	5	B-64870-5	-	58,00
32 x 50	BiM / Madera	20	B-64870-20	0088381541237	211,00

Cuchilla de inmersión 24



TMA050



- Cajeados en muebles.
- Cortes al ras en madera. Cortes profundos en madera blanda.
- Cortes de inmersión en madera blanda.

Tamaño (mm)	Material / Indicado para	Unds.	Código	EAN	P.V.P. (€)
24 x 50	HCS / Madera	1	B-64842	0088381536349	8,00
24 x 50	HCS / Madera	1	B-64842-5	0088381536349	41,00



Cuchilla de inmersión 20



TMA058



- Metal. Adecuado para corte al ras en clavos o tubo de cobre.
- Cortes en zócalos.

Tamaño (mm)	Material / Indicado para	Unds.	Código	EAN	P.V.P. (€)
20 x 30	BiM / Metal	1	B-64923	0088381536424	8,75

Cuchilla de inmersión 32



TMA061



- Corte de acero inoxidable.
- Adecuado para corte al ras en tornillos y clavos endurecidos.
- Corte de fibra de vidrio.

Tamaño (mm)	Material / Indicado para	Unds.	Código	EAN	P.V.P. (€)
32 x 40	TC / HM, Metal	1	B-64951	0088381536455	23,00

Cuchilla de inmersión 32



TMA059



- Cortes en zócalos.
- Metal. Adecuado para corte al ras en clavos o tubo de cobre.

Tamaño (mm)	Material / Indicado para	Unds.	Código	EAN	P.V.P. (€)
32 x 50	BiM /Metal	1	B-64939	0088381536431	11,35

Cuchilla de inmersión 10



TMA057



- Metal. Adecuado para corte al ras en clavos.
- Cortes de inmersión en placas de yeso.
- Cortes en zócalos.

Tamaño (mm)	Material / Indicado para	Unds.	Código	EAN	P.V.P. (€)
10 x 30	HCS / Madera	1	B-64917	0088381536417	7,70

Cuchilla de inmersión 20



TMA060



- Corte de acero inoxidable.
- Adecuado para corte al ras en tornillos y clavos endurecidos.
- Corte de fibra de vidrio.

Tamaño (mm)	Material / Indicado para	Unds.	Código	EAN	P.V.P. (€)
20 x 40	TC / HM, Metal	1	B-64945	0088381536448	19,55

Cuchilla de inmersión 32



TMA054



- Cajeados en muebles.
- Cortes de inmersión en madera.

Tamaño (mm)	Material / Indicado para	Unds.	Código	EAN	P.V.P. (€)
32 x 50	HCS / Madera	1	B-64886	0088381536387	11,35

Rascadores



Rascador rígido 52



TMA065



- Retirar restos de moqueta, lechada...
- Eliminación de residuos: Adhesivo, mortero y hormigón.

Tamaño (mm)	Material / Indicado para	Unds.	Código	EAN	P.V.P. (€)
52 x 26	HCS	1	B-64989	0088381536486	9,00

Rascador flexible 52



TMA066



- Eliminación de residuos de pintura.
- Retirar juntas de silicona.
- Eliminación de residuos de adhesivos de alfombras.

Tamaño (mm)	Material / Indicado para	Unds.	Código	EAN	P.V.P. (€)
52 x 40	HCS	1	B-64995	0088381536493	9,25

Cuchillas de corte



Cuchilla segmentada de sierra 100



TMA063



- Ideal para materiales de aislamiento.
- Corte de poliestireno a ras.
- Cortar materiales blandos (moqueta, cuero...)

Ø (mm)	Material / Indicado para	Unds.	Código	EAN	P.V.P. (€)
100	BiM	1	B-64967	0088381536462	23,00

Cuchilla de corte 28



TMA067



- Cortar juntas de expansión blandas.
- Retirar silicona de ventanas.
- Recortar material aislante.

Tamaño (mm)	Material / Indicado para	Unds.	Código	EAN	P.V.P. (€)
28 x 40	HCS	1	B-65006	0088381536509	15,95

Cuchilla universal multicorte 11



TMA068



- Cortar juntas de expansión blandas.
- Retirar silicona de ventanas.
- Recortar material aislante.

Tamaño (mm)	Material / Indicado para	Unds.	Código	EAN	P.V.P. (€)
11 x 24	HCS	1	B-65012	0088381536516	17,00



Limpieza y corte



Cuchilla de limpieza HM 32



TMA075



Corte por inmersión y raspado en fibra de vidrio.

- Eliminar las lechadas en esquinas estrechas o juntas de cemento.

Tamaño (mm)	Material / Indicado para	Unds.	Código	EAN	P.V.P. (€)
32 x 30	TC / HM Grano 50	1	B-65084	0088381536585	23,00

Cuchilla de limpieza HM 32



TMA076



- Lijado de barniz o pinturas en zonas de difícil acceso.
- Lijado de madera, compuesto de madera-plástico y epoxy.

Tamaño (mm)	Material / Indicado para	Unds.	Código	EAN	P.V.P. (€)
32 x 50	TC / HM Grano 40	1	B-65090	0088381536592	21,00

Cuchilla de limpieza HM 32



TMA077



- Lijado de barniz o pinturas en zonas de difícil acceso.
- Lijado de madera, compuesto de madera-plástico y epoxy.

Tamaño (mm)	Material / Indicado para	Unds.	Código	EAN	P.V.P. (€)
32 x 50	TC / HM Grano 100	1	B-65109	0088381536608	21,00

Cuchilla de limpieza HM



TMA074



- Para levantar mortero.
- Limpiar las juntas de los azulejos de suelo.
- Limpieza de juntas de esquinas con la punta de carburo de tungsteno.

Tamaño (mm)	Material / Indicado para	Unds.	Código	EAN	P.V.P. (€)
70	TC / HM Grano 40	1	B-65078	0088381536578	36,00

Cuchilla de limpieza HM 85



TMA069



- Limpieza de juntas en pared y suelo.
- Pequeños cortes en azulejo blando.
- Realizar rozas en hormigón poroso para cables y tuberías.

Ø (mm)	Material / Indicado para	Unds.	Código	EAN	P.V.P. (€)
85	TC / HM Grano 40	1	B-65028	0088381536523	26,00

Cuchilla de corte y limpieza diamante segmentada HM 85



TMA070



- Pequeños cortes en azulejo blando.
- Realizar rozas en epoxy, fibra de vidrio, pvc, porcelánico.

Ø (mm)	Material / Indicado para	Unds.	Código	EAN	P.V.P. (€)
85	TC / HM Grano 40	1	B-65034	0088381536530	42,00

Cuchilla de corte y limpieza segmentada HM 70



TMA071



- Limpieza de juntas en pared y suelo.
- Pequeños cortes en azulejo blando.
- Realizar rozas en hormigón poroso para cables y tuberías.

Ø (mm)	Material / Indicado para	Unds.	Código	EAN	P.V.P. (€)
70	TC / HM Grano 50	1	B-65040	0088381536547	23,00

Cuchilla de corte y limpieza segmentada HM 85



TMA072



- Limpieza de juntas en pared y suelo.
- Pequeños cortes en azulejo blando.
- Realizar rozas en hormigón poroso.

Ø (mm)	Material / Indicado para	Unds.	Código	EAN	P.V.P. (€)
85	TC / HM Grano 40	1	B-65056	0088381536554	22,00

Cuchilla de limpieza

Cuchilla de limpieza TC HM 78 STARLOCK

TMA073



- Retirar mortero o cola de azulejo.
- Limpiar adhesivo de las alfombras.

Tamaño (mm)	Material / Indicado para	Unds.	Código	EAN	P.V.P. (€)
78	TC / HM Grano 20	1	B-65062	0088381536561	22,00

Plato de lija 93

STARLOCK

TMA078



Tamaño (mm)	Material / Indicado para	Unds.	Código	EAN	P.V.P. (€)
93	Velcro	1	B-65115	0088381536615	11,35

Set de cuchillas

Set de cuchillas de inmersión

TMA045 Cuchilla de corte segmentada

TMA047 Cuchilla de inmersión 32

TMA053 Cuchilla de inmersión 32

TMA058 Cuchilla de inmersión 20



Tamaño (mm)	Material / Indicado para	Unds.	Código	EAN	P.V.P. (€)
-	Cortes por inmersión	4	B-67480	0088381541145	45,00

Set de cuchillas para azulejo

TMA058 Cuchilla de inmersión 20

TMA065 Rascador rígido 52

TMA069 Cuchilla de limpieza HM 85

TMA073 Cuchilla de limpieza TC HM 78



Tamaño (mm)	Material / Indicado para	Unds.	Código	EAN	P.V.P. (€)
-	Azulejo	4	B-67496	0088381541152	54,00



Tabla de aplicación - Lijas para multiherramienta

		Grano	Pintura	Barniz	Lacas	Yeso	Madera	Madera blanca	Madera dura	Contrachapado de madera	Aglomerado / MDF	Fibra de vidrio / Plásticos	Metal	Acero	Piedra	Mármol	Granito	Vidrio	Metacrilato	
Madera / long life	Grueso	60																		
		80																		
	Medio	100	-	-	-	-	✓✓	✓✓	✓✓	✓✓	✓	✓✓	✓	-	-	-	-	-	-	
		120																		
		180																		
Fino	240																			
Madera	Grueso	60																		
		80																		
	Medio	100	-	-	-	-	✓✓	✓	✓✓	✓✓	✓	-	-	-	-	-	-	-	-	
		120																		
		150																		
Fino	180																			
	240																			
Pintura	Grueso	60																		
		80																		
	Medio	100	✓✓	✓✓	✓✓	✓✓	-	-	✓	-	-	✓	✓	-	-	-	-	-	-	
		120																		
		240																		
Fino	320																			
Piedra	Medio	120																		
		240	✓	✓✓	-	-	-	-	-	-	✓	-	-	✓	✓	✓	✓	✓		
	Fino	400																		
		600																		
		1200																		



Lijas

Lijas para madera

- Adecuado para lijar madera, madera dura, aglomerado, tableros de construcción y metal.



Medida (mm)	Tipo	Grano	Unds.	Código	EAN	P.V.P. (€)
93 x 93 x 93	Madera	60	10	B-21624	0088381401081	3,60
		80	10	B-21630	0088381401098	3,35
		100	10	B-22947	0088381403344	3,35
		120	10	B-21646	0088381401104	3,35
		150	10	B-22953	0088381403351	3,35
		180	10	B-21652	0088381401111	3,35
		240	10	B-21668	0088381401128	3,35
		60, 80, 120, 180, 240	10 (2 de cada)	B-21618	0088381401074	3,90

Lijas para pintura y barniz

- Adecuado para lijar pintura, barniz o desbaste.



Medida (mm)	Tipo	Grano	Unds.	Código	EAN	P.V.P. (€)
93 x 93 x 93	Pintura	60	10	B-21680	0088381401142	3,85
		80	10	B-21696	0088381401159	3,85
		100	10	B-21705	0088381401166	3,85
		120	10	B-22969	0088381403368	3,85
		240	10	B-21711	0088381401173	3,85
		320	10	B-21727	0088381401180	3,85
		60, 80, 100, 240, 320	10 (2 de cada)	B-21674	0088381401135	4,10

Abrasivo de lana para eliminar óxido del metal y la suciedad de la madera

- Adecuado para eliminar el óxido del metal y la suciedad de la madera.



Medida (mm)	Tipo	Grano	Unds.	Código	EAN	P.V.P. (€)
93 x 93 x 93	Lana	100	1	B-21808	0088381401265	3,10
		280	1	B-21799	0088381401258	3,10
		Sin grano	1	B-21814	0088381401272	3,10

Kit de aspiración



Modelo	Unds.	Código	EAN	P.V.P. (€)
TM3000C	1	196022-7	0088381411493	5,15
TM3010C	1	199624-8	0088381545297	8,25
DTM51	1	199627-2	0088381545327	10,75
DTM52	1	191R02-6	0088381580564	11,20

Lijas para madera dura, tableros de obra y metal

- Adecuado para trabajos en madera, plástico, metal en planchas, maderas barnizadas y metales pintados.



Medida (mm)	Tipo	Grano	Unds.	Código	EAN	P.V.P. (€)
93 x 93 x 93	Madera dura	40	10	P-33255	0088381961417	3,85
		60	10	P-33261	0088381961424	3,85
		80	10	P-33277	0088381961431	3,85
		100	10	P-33283	0088381961448	3,60
		120	10	P-33299	0088381961455	3,60
		180	10	P-33314	0088381961479	3,60
		240	10	P-33320	0088381961486	3,60
		60, 80, 100, 120, 180	10 (2 de cada)	B-21559	0088381401012	4,10

Lijas para materiales duros como piedra, mármol o cristal

- Adecuado para el lijado grueso o brillante de materiales duros como piedra, mármol o cristal.



Medida (mm)	Tipo	Grano	Unds.	Código	EAN	P.V.P. (€)
93 x 93 x 93	Piedra	120	10	B-21749	0088381401203	3,85
		240	10	B-21755	0088381401210	3,85
		400	10	B-21761	0088381401227	3,85
		600	10	B-21777	0088381401234	3,60
		1200	10	B-21783	0088381401241	3,60
		120, 240, 400, 600, 1200	10 (2 de cada)	B-21733	0088381401197	4,10

Filtro para el pulido previo de superficies sucias o ralladas

- Filtro para el pulido previo de superficies sucias o ralladas.



Medida (mm)	Tipo	Grano	Unds.	Código	EAN	P.V.P. (€)
93 x 93 x 93	Filtro	Duro	1	B-21820	0088381401289	3,10

Adaptador universal



Unds.	Código	EAN	P.V.P. (€)
1	313248-8	0088381416528	2,60

STARLOCK MAX



Accesorios de corte

C. de corte segmentada 100 **STARLOCK MAX**

MAM003



- Adecuada para cortes rectos largos, cortes profundos y anchos en madera y metal.
- También puede cortar epoxy y fibra de vidrio.

Tamaño (mm)	Material / Indicado para	Unds.	Código	EAN	P.V.P. (€)
100 x 50	BiM / Madera y metal	1	B-66422	0088381539326	23,00

Accesorios de corte de inmersión



Cuchilla de inmersión curva 32 **STARLOCK MAX**

MAM006



- Adecuado para corte de inmersión con precisión, corte profundo y rápido en multimaterial.
- También puede cortar madera, epoxy, fibra de vidrio y hormigón poroso.

Tamaño (mm)	Material / Indicado para	Unds.	Código	EAN	P.V.P. (€)
32 x 70	TC / HM, Multimaterial	1	B-66450	0088381539357	24,00

Cuchilla de inmersión 32 **STARLOCK MAX**

STARLOCK MAX

MAM005

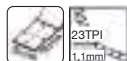

- Adecuado para corte de inmersión, corte profundo y rápido en metal.
- También puede cortar epoxy, fibra de vidrio, hormigón poroso y madera.

Tamaño (mm)	Material / Indicado para	Unds.	Código	EAN	P.V.P. (€)
32 x 70	TC / HM, Metal	1	B-66444	0088381539340	23,00

Cuchilla de inmersión curva 32 **STARLOCK MAX**

MAM004



- Adecuado para corte de inmersión precisa, corte profundo y rápido en madera.
- No se puede usar para cortar otros materiales.

Tamaño (mm)	Material / Indicado para	Unds.	Código	EAN	P.V.P. (€)
32 x 80	HCS / Madera	1	B-66438	0088381539333	10,05

Cuchilla de inmersión curva 52 **STARLOCK MAX**

STARLOCK MAX

MAM002



- Adecuada para corte de inmersión con precisión, corte profundo y ancho especialmente en madera y metal.
- También puede cortar epoxy y fibra de vidrio.

Tamaño (mm)	Material / Indicado para	Unds.	Código	EAN	P.V.P. (€)
52 x 70	BiM / Madera y metal	1	B-66416	0088381539319	13,90

Cuchilla de inmersión curva 32 **STARLOCK MAX**

MAM001



- Adecuada para corte de inmersión con precisión, corte profundo y rápido especialmente en madera y metal.
- También puede cortar epoxy y fibra de vidrio.

Tamaño (mm)	Material / Indicado para	Unds.	Código	EAN	P.V.P. (€)
32 x 80	BiM / Madera y metal	1	B-66400	0088381539302	12,90

Cuchillas de corte de juntas



Cuchillas de diamante



Cuchilla de corte de juntas 32 STARLOCK MAX

MAM008



- Adecuada para corte de juntas blandas, corte profundo y ancho.
- No es posible cortar en otro material.

Tamaño (mm)	Material / Indicado para	Unds.	Código	EAN	P.V.P. (€)
32 x 55	HCS / Juntas blandas	1	B-66472	0088381539371	6,70

C. de corte segmentada 68 STARLOCK MAX

MAM011



- Adecuada para el recorte de baldosas de pared blandas.
- También puede cortar yeso, epoxy y fibra de vidrio.

Tamaño (mm)	Material / Indicado para	Unds.	Código	EAN	P.V.P. (€)
68 x 30	Diamante Grano 40, corte de baldosas y azulejos de pared	1	B-66519	0088381539418	38,00



Cuchilla de corte de juntas 32 STARLOCK MAX

MAM007



- Adecuada para corte de juntas blandas, corte profundo y rápido.
- No es posible cortar otros materiales.

Tamaño (mm)	Material / Indicado para	Unds.	Código	EAN	P.V.P. (€)
32 x 70	HCS / Juntas blandas	1	B-66466	0088381539364	13,40



Cuchillas de corte para azulejos



C. de corte segmentada 68 **STARLOCK MAX**

MAM009



- Adecuada para cortar juntas en azulejos de pared.
- También puede cortar en cartón yeso, epoxy y fibra de vidrio.



Tamaño (mm)	Material / Indicado para	Unds.	Código	EAN	P.V.P. (€)
68 x 10	TC/HM Grano 50, juntas de azulejos de pared	1	B-66494	0088381539395	28,00

C. de corte segmentada 68 **STARLOCK MAX**

MAM010



- Adecuado para el corte de juntas en azulejos de pared.
- Capaz de cortar otros materiales como cartón yeso, epoxy, fibra de vidrio.



Tamaño (mm)	Material / Indicado para	Unds.	Código	EAN	P.V.P. (€)
68 x 30	TC/HM Grano 30, juntas de azulejos de pared	1	B-66503	0088381539401	28,00

C. de corte segmentada 100 **STARLOCK MAX**

MAM014



- Adecuada para cortar juntas en azulejos de pared.
- También se puede cortar en madera, epoxy y fibra de vidrio.



Tamaño (mm)	Material / Indicado para	Unds.	Código	EAN	P.V.P. (€)
100 x 50	TC / HM Grano 40, juntas de azulejos de pared	1	B-66547	0088381539449	27,00



Limpieza y corte



Cuchilla de limpieza 116 **STARLOCK MAX**

MAM015



- Adecuada para limpiar azulejos de pared.
- También puede limpiar madera y fibra de vidrio.



Ø (mm)	Material / Indicado para	Unds.	Código	EAN	P.V.P. (€)
116	TC/HM Grano 20, limpieza de azulejos	1	B-66553	-	21,00



Cuchilla de limpieza 116 **STARLOCK MAX**

MAM017



- Adecuada para limpiar madera.
- También puede limpiar derivados de madera.



Ø (mm)	Material / Indicado para	Unds.	Código	EAN	P.V.P. (€)
116	TC / HM Grano 60, limpieza de madera	1	B-66575	0088381539470	21,00

Sierras

- Circulares
- Ingletadoras
- Incisión













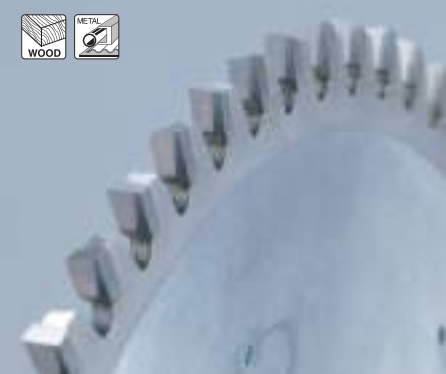
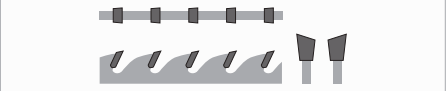

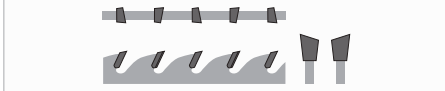
MFORCE™

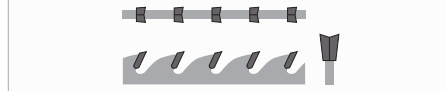
SPECIALIZED

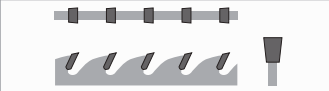
EFFICUT

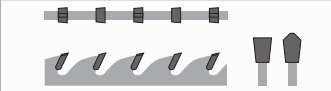

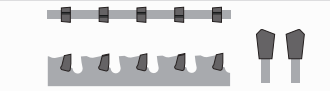

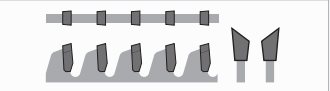













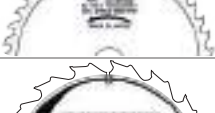



Tipos de dentado













<p>ATB</p>   	<p>ATAF</p>   	<p>M-FORCE</p>   	
<p>FTG</p>   	<p>TCG</p>   	<p>SMTCG</p>   	<p>HI - ATB</p>   

Tecnología

<p>Hendidura láser</p> <p>Láser slit</p>  <p>Reduce el ruido y las vibraciones.</p>	<p>Recubierto</p>  <p>Recubierto de PTFE (politetrafluoroetileno) que reduce la acumulación de suciedad y baja la resistencia sobre el material.</p>	<p>Reforzado</p>  <p>El diseño de diente embutido incrementa la superficie de agarre para soportar trabajos más duros.</p>
--	---	--





Tipos de discos para sierras circulares, ingletadoras y sierras de incisión

			85mm	136mm	165mm	185mm	190mm	210mm	235mm	270mm	355mm
MAKFORCE			-	-	160mm	170mm	180mm	230mm	✓	✓	✓
SPECIALIZED REFORZADO			-	-	✓	✓	✓	✓	✓	✓	✓
MFORCE			-	-	✓	✓	-	-	✓	-	-
SPECIALIZED STANDARD			-	-	✓	✓	-	✓	✓	-	-
SPECIALIZED STANDARD economy			-	-	✓	✓	✓	-	✓	-	-
SPECIALIZED ALUMINIO			-	-	160mm	-	✓	✓	✓	-	360mm
SPECIALIZED CONSTRUCCION			-	-	-	-	✓	✓	✓	-	-
SPECIALIZED PANEL SANDWICH			-	-	✓	-	-	-	✓	✓	✓
SPECIALIZED MAQUINAS DE BATERIA			✓	✓	✓	-	✓	-	✓	-	-
SPECIALIZED INCISION			-	-	160mm	-	-	-	-	-	-

			136mm	165mm	190mm	216mm	250mm	260mm	300mm	305mm	315mm
MAKBLADE PLUS			-	-	✓	-	✓	-	-	-	-
MAKBLADE			-	-	✓	✓	✓	255mm	260mm	✓	-
SPECIALIZED ALUMINIO			-	-	✓	✓	-	✓	-	✓	350mm
SPECIALIZED S. MESA			-	-	-	210 mm	-	✓	-	-	✓
SPECIALIZED S. MESA			-	-	-	-	-	✓	✓	-	350mm
SPECIALIZED LAMINADOS			✓	✓	✓	✓	-	✓	-	✓	-

EFFICUT

Características del tipo de diente EFFICUT

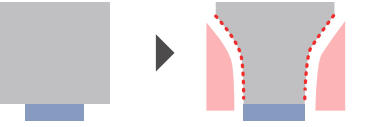
	<p>Ángulo superior agudo</p> 	<p>Permite realizar cortes finos sin esfuerzo.</p>
	<p>Cuerpo curvo</p> 	<p>Permite evacuar la viruta de forma muy eficiente.</p>
	<p>Base rectificada</p> 	<p>Alarga la vida de la batería al tener que realizar menos esfuerzo en cada corte.</p>

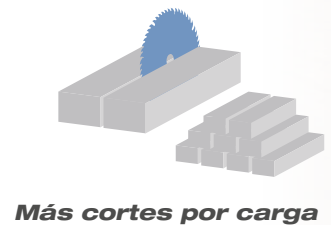

Hoja: 1,6 mm **Cantidad de cortes con una carga**

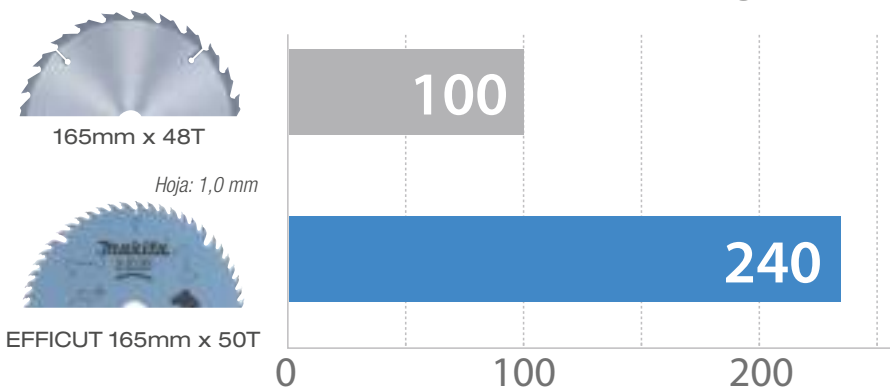

**x2,4
VECES MÁS**

1. Los resultados de la prueba dependen en gran medida de la dureza de la madera, etc.
 2. Los gráficos de barras de la cantidad de cortes son valores relativos cuando la capacidad de la hoja actual (grosor: 1,6 mm) es 100.

**CORDLESS
SAWS**



Discos de sierra para sierras circulares

Discos Makforce



Una extensa selección de discos para todas las marcas y modelos de sierras circulares portátiles.

Amplia gama de medidas, desde 160mm hasta 355mm y de número de dientes desde 12 hasta 60. La gama abarca un gran número de aplicaciones desde corte grueso y corte transversal a corte fino y longitudinal.

- La estructura del disco es de acero tensionado de precisión, absorbe los impactos sin deformarse.
- Carburo de tungsteno de alta calidad y bajo desgaste para una larga vida de la sierra.
- Afilado perfecto para cortes más precisos.
- Corte fino, con menos viruta y menos esfuerzo en el motor.

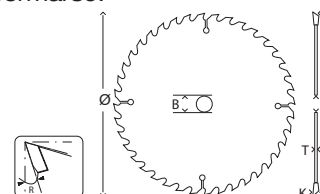

Ø 165mm DHS660 - DHS661 - DHS680 - DSS610 - HS6100 - HS6601

Ø ext. (mm)	Ø int. (mm)	K (mm)	T (mm)	Nº dientes	R	Tipo de diente	Reducción	Código	EAN	P.V.P (€)
160	20	2,4	1,5	16	20°	ATB	15,88	B-32091	0088381420907	18,45
160	20	2,4	1,5	24	20°	ATB	15,88	B-32203	0088381421010	22,00
160	20	2,4	1,5	40	20°	ATB	15,88	B-32297	0088381421102	27,00
165	20	2,4	1,5	10	20°	FTG	-	B-32100	0088381420914	22,00
170	30	2,4	1,5	16	20°	ATB	15,88	B-32122	0088381420938	21,00
170	30	2,4	1,5	24	20°	ATB	15,88	B-32225	0088381421034	23,00
170	30	2,4	1,5	40	20°	ATB	15,88	B-32312	0088381421126	25,00

Ø 190mm DHS710 - DHS782 - DHS783 - HS7601 - HS7100 - HS7101 - M5802B - HS004G

180	20	2,4	1,5	16	20°	ATB	-	B-08187	0088381336178	18,55
180	20	2,4	1,5	24	20°	ATB	-	B-08327	0088381336314	23,00
190	30	2	1,4	12	20°	FTG	20/15,88	B-32144	0088381420952	23,00
190	30	2,2	1,4	24	20°	ATB	20/15,88	B-32247	0088381421058	24,00
190	30	2,2	1,4	40	20°	ATB	20/15,88	B-32340	0088381421157	32,00
190	30	2,2	1,4	60	15°	ATAF	20/15,88	B-32390	0088381421201	35,00

Ø 210mm 5008MG

210	30	2,4	1,6	16	20°	ATB	-	B-32150	0088381420969	23,00
210	30	2,4	1,6	24	20°	ATB	-	B-32253	0088381421065	29,00
210	30	2,4	1,6	40	20°	ATB	-	B-32356	0088381421164	34,00

Ø 235mm 5903R - 5903RK - DHS900 - HS009G

235	30	2,3	1,6	20	20°	ATB	-	B-32269	0088381421072	24,00
235	30	2,6	1,6	40	20°	ATB	-	B-32362	0088381421171	30,00
235	30	2,8	1,8	60	15°	ATAF	-	B-32415	0088381421225	32,00

Ø 270mm 5103R - HS0600

270	30	2,6	1,8	24	20°	ATB	-	B-32172	0088381420983	37,00
270	30	2,6	1,6	40	20°	ATB	-	B-32378	0088381421188	43,00
270	30	2,8	1,8	60	15°	ATAF	-	B-32409	0088381421218	47,00

Ø 355mm 5143R

355	30	3,0	2,2	24	20°	ATB	-	B-32188	0088381420990	52,00
355	30	3,0	2,2	40	20°	ATB	-	B-32281	0088381421096	59,00
355	30	3,0	2,2	60	20°	ATB	-	B-32384	0088381421195	63,00



WOOD

Discos de sierra para sierras circulares

Discos Specialized Reforzado



Diseñados para sierras circulares de Makita y otros fabricantes de sierras, los dientes reforzados o “dientes embutidos” son especialmente resistentes y con bajo desgaste. Para cortes fáciles en maderas con nudos. Diseñado para evitar que salten los dientes cuando se corten clavos en madera accidentalmente.

Especialmente apropiado para la recuperación de madera y de trabajos de demolición.

- Corte en madera con clavos accidentales y nudos.
- Extremadamente resistente y de bajo desgaste.
- Aumentan la vida de la sierra y la productividad.
- Corte fino, con menos viruta y menos esfuerzo en el motor.

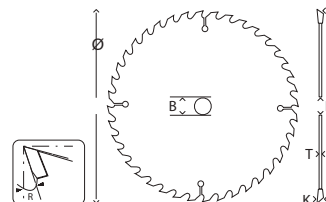

Ø 165mm DHS660 - DHS661 - DHS680 - DSS610 - HS6100 - HS6601

Ø ext. (mm)	Ø int. (mm)	K (mm)	T (mm)	Nº dientes	R	Tipo de diente	Reducción	Código	EAN	P.V.P (€)
165	20	2	1,25	16	23°	ATB Reforzado	-	B-33037	0088381421904	26,00
165	20	2	1,25	24	23°	ATB Reforzado	-	B-33093	0088381421966	30,00
165	20	2	1,25	40	18°	ATB Reforzado	-	B-33168	0088381422031	34,00

Ø 190mm DHS710 - DHS782 - DHS783 - HS7601 - HS7100 - HS7101 - M5802B - HS004G

185	30	2	1,25	16	25°	ATB Reforzado	-	B-33043	0088381421911	21,00
185	30	2	1,25	40	25°	ATB Reforzado	-	B-33174	0088381422048	27,00
190	30	2	1,25	16	23°	ATB Reforzado	-	B-33059	0088381421928	21,00
190	30	2	1,25	24	23°	ATB Reforzado	-	B-33118	0088381421980	29,00
190	30	2	1,25	40	23°	ATB Reforzado	-	B-33180	0088381422055	38,00

Ø 210mm 500BMG

210	30	1,9	1,4	18	23°	ATB Reforzado	-	B-09363	0088381337403	25,00
-----	----	-----	-----	----	-----	---------------	---	---------	---------------	-------

Ø 235mm 5903R - 5903RK - DHS900 - HS009G

235	30	2,3	1,6	24	23°	ATB Reforzado	-	B-33130	0088381422000	31,00
235	30	2,3	1,6	48	18°	ATB Reforzado	-	B-33196	0088381422062	48,00

Ø 270mm 5103R - HS0600

270	30	2,6	1,8	24	23°	ATB Reforzado	-	B-33146	0088381422017	60,00
270	30	2,6	1,8	40	18°	ATB Reforzado	-	B-33205	0088381422079	74,00
270	30	2,6	1,8	60	18°	ATB Reforzado	-	B-33211	0088381422086	75,00

Ø 355mm 5143R

355	30	3	2,2	24	23°	ATB Reforzado	-	B-33087	0088381421959	81,00
355	30	3	2,2	60	18°	ATB Reforzado	-	B-33227	0088381422093	107,00



Discos de sierra para sierras circulares

Discos MForce



Diseño avanzado y revolucionario para sierras circulares.

El diente con doble cara biselada tiene un corte fino y el diseño en "M" hace el efecto del doble diente.

Mayor superficie de corte del diente se traduce en una duración mayor que los discos tradicionales. Un corte y un diente estrecho reduce la fricción consiguiendo así un menor aumento de la corriente, protegiendo el motor de su sierra. Corte en madera con clavos accidentales y nudos.

- Acabado perfecto, ya que el número de dientes en M se multiplica por 2.
- Corte agresivo.
- Área de trabajo más grande.
- Más duradero.

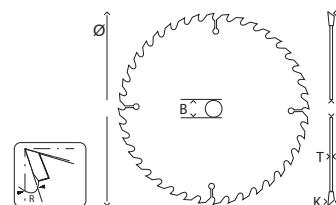

Ø 165mm DHS660 - DHS661 - DHS680 - DSS610 - HS6100 - HS6601

Ø ext. (mm)	Ø int. (mm)	K (mm)	T (mm)	Nº dientes	R	Tipo de diente	Reducción	Código	EAN	P.V.P (€)
165	20	2	1,2	16	15°	M-Force	-	B-31930	0088381420747	14,70
165	20	2	1,2	24	15°	M-Force	-	B-32007	0088381420815	17,90

Ø 190mm DHS710 - DHS782 - DHS783 - HS7601 - HS7100 - HS7101 - M5802B - HS004G

185	30	2	1,2	24	15°	M-Force	20/15,88	B-32035	0088381420846	21,00
-----	----	---	-----	----	-----	---------	----------	---------	---------------	-------

Ø 235mm 5903R - 5903RK - DHS900 - HS009G

235	30	2,3	1,6	40	15°	M-Force	25/15,88	B-32085	0088381420891	32,00
-----	----	-----	-----	----	-----	---------	----------	---------	---------------	-------



Discos Specialized Standard



Diseñados para sierras circulares Makita y otros fabricantes de sierras.

Ø 165mm DHS660 - DHS661 - DHS680 - DSS610 - HS6100 - HS6601

Ø ext. (mm)	Ø int. (mm)	K (mm)	T (mm)	Nº dientes	R	Tipo de diente	Reducción	Código	EAN	P.V.P (€)
165	20	2,4	1,5	10	20°	ATB	-	D-03327	0088381173667	11,45
165	20	2,0	1,5	16	20°	ATB	-	D-09628	0088381184816	12,60
165	20	2,4	1,5	24	20°	ATB	-	D-03333	0088381173674	13,75
165	20	2,4	1,5	40	18°	ATB	-	D-03349	0088381173681	16,60

Ø 190mm DHS710 - DHS782 - DHS783 - HS7601 - HS7100 - HS7101 - M5802B - HS004G

185	30	1,8	1,2	16	20°	ATB	20	D-03903	0088381174336	12,60
185	30	2,0	1,2	20	20°	ATB	30/20	D-09634	0088381184823	13,70
185	30	1,8	1,2	40	18°	ATB	20	D-03919	0088381174343	15,45

Ø 210mm 5008MG

210	30	2,0		24	20°	ATB	-	D-29050	0088381343466	23,00
-----	----	-----	--	----	-----	-----	---	---------	---------------	-------

Ø 235mm 5903R - 5903RK - DHS900 - HS009G

235	30	2,3	1,6	20	20°	ATB	25	D-03925	0088381174350	19,20
235	30	2,3	1,6	48	18°	ATB	25	D-03931	0088381174367	23,00
235	30	2,3	1,6	60	15°	ATB	25	D-09640	0088381184830	29,00



Discos de sierra para sierras circulares

Discos Specialized Standard Economy



- Diseñados para sierras circulares Makita y otros fabricantes de sierras.
- Cortes en maderas blandas.
- Excelente calidad / precio.

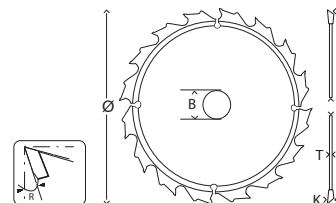

Ø 165mm DHS660 - DHS661 - DHS680 - DSS610 - HS6100 - HS6601

Ø ext. (mm)	Ø int. (mm)	K (mm)	T (mm)	Nº dientes	R	Tipo de diente	Reducción	Código	EAN	P.V.P (€)
165	20	2,0	1,2	16	12°	ATB	-	D-52554	0088381444422	7,20
165	20	2,0	1,2	24	12°	ATB	-	D-52560	0088381444439	8,45
165	20	2,0	1,2	40	12°	ATB	-	D-52576	0088381444446	10,25

Ø 190mm DHS710 - DHS782 - DHS783 - HS7601 - HS7100 - HS7101 - M5802B - HS004G

185	30	2,2	1,4	16	18°	ATB	-	D-52582	0088381444453	9,05
185	30	2,2	1,4	24	15°	ATB	-	D-52598	0088381444460	10,25
185	30	2,2	1,4	40	14°	ATB	-	D-52607	0088381444477	11,45

Ø 190mm DHS710 - DHS782 - DHS783 - HS7601 - HS7100 - HS7101 - M5802B - HS004G

190	30	2,2	1,4	24	15°	ATB	-	D-64951	0088381533096	10,55
190	30	2,2	1,4	40	15°	ATB	-	D-64967	0088381533102	12,05
190	30	2,0	1,4	40	18°	ATB	-	D-64973	0088381533119	14,35

Ø 210mm - 5008MG

210	30	-	-	24	-	-	-	D-72291	0088381569026	13,05
210	30	-	-	40	-	-	-	D-72300	0088381569033	14,25

Ø 235mm 5903R - 5903RK - DHS900 - HS009G

235	30	2,5	1,6	20	14°	ATB	-	D-52613	0088381444484	15,65
235	30	2,5	1,6	40	12°	ATB	-	D-52629	0088381444491	18,10
235	30	2,5	1,6	60	12°	ATB	-	D-52635	0088381444507	20,50



Discos de sierra para sierras circulares

Discos Specialized Aluminio



Amplia gama de discos para sierras circulares con un excelente rendimiento de corte en aluminio, latón, bronce y otros metales no ferrosos. Los discos también son válidos para trabajar en plásticos y maderas laminadas. Aplicar cera de discos en la zona del diente frecuentemente para prevenir la acumulación de viruta en los dientes cuando cortemos metales no ferrosos.

- La estructura del disco es de acero tensionado de precisión para mayor rigidez y cortes más rectos.
- Excelente calidad de corte en materiales no ferrosos.
- Perfecta realización del corte en suelos laminados.

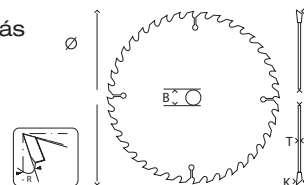

Ø 165mm DHS680 - DHS660 - DHS661 - DSS610 - HS6601 - HS6100										
Ø ext. (mm)	Ø int. (mm)	K (mm)	T (mm)	Nº dientes	R	Tipo de diente	Reducción	Código	EAN	P.V.P (€)
160	20	2,4	1,8	60	0°	TCG	-	B-33233	0088381422109	39,00
Ø 190mm DHS710 - DHS782 - DHS783 - HS7601 - HS7100 - HS7101 - M5802B - HS004G										
190	30	2,4	1,8	60	0°	TCG	20/15,88	B-33261	0088381422130	55,00
Ø 210mm 5008MG										
210	30	2,8	2	54	-5°	TCG	25	B-33548	0088381422437	55,00
Ø 235mm 5903R - 5903RK - DHS900 - HS009G										
235	30	2,4	1,8	80	0°	TCG	-	B-33277	0088381422147	63,00

Discos Specialized Construcción



Estos discos están indicados para maderas de construcción, maderas de encofrados, maderas con clavos, maderas prensadas, maderas con residuos de hormigón.

- El diente está embutido dentro del cuerpo del disco, para conseguir una gran resistencia.
- Los dientes pueden ser reafilados para un mayor aprovechamiento del disco.
- Gracias a su estructura reforzada conseguimos cortes rectos sin desviaciones sin necesidad de ninguna guía.

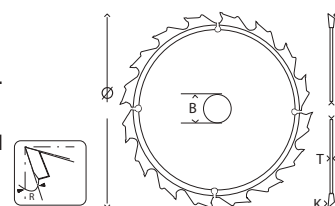

Ø 190mm DHS710 - DHS782 - DHS783 - HS7601 - HS7100 - HS7101 - M5802B - HS004G										
Ø ext. (mm)	Ø int. (mm)	K (mm)	T (mm)	Nº dientes	R	Tipo de diente	Reducción	Código	EAN	P.V.P (€)
190	30	2,6	1,6	12	20°	FTG Reforzado	-	B-33554	0088381422444	26,00
Ø 210mm 5008MG										
210	30	2,8	1,8	14	20°	FTG Reforzado	-	B-27246	0088381411172	28,00
Ø 235mm 5903R - 5903RK - DHS900 - HS009G										
235	30	2,8	1,8	16	20°	FTG Reforzado	-	B-13699	0088381359801	32,00

Discos de sierra para sierras circulares

Discos Specialized Panel Sandwich



Discos con diente de HM para el corte específico de panel sandwich.

Diente con forma triangular contrapuesto:

- Reduce la rebaba en la pieza.
- Evita la rotura del disco.
- Ranuras para evitar vibración y ruido.

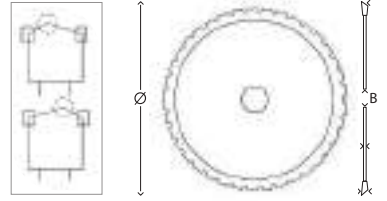

- Ideal para su utilización en nuestros modelos 5903R, 5104S, 5103R y 5143R.
- Larga duración. Muy buen acabado gracias al tipo de diente.



Ø 165mm DHS660 - DHS661 - DSS610 - DHS680 - HS6601 - HS6100

Ø ext. (mm)	Ø int. (mm)	K (mm)	T (mm)	Nº dientes	R	Tipo de diente	Reducción	Código	EAN	P.V.P (€)
165	20	1,75	1,4	42	0°	SMTCG LaserSlit	-	B-63149	-	59,00

Ø 235mm 5903R - 5903RK - DHS900 - HS009G

235	30	2,2	1,8	50	-	SMTCG LaserSlit	-	B-33582	0088381422475	87,00
-----	----	-----	-----	----	---	-----------------	---	---------	---------------	-------

Ø 270mm 5103R - HS0600

270	30	2,4	2	60	-	SMTCG LaserSlit	-	B-33598	0088381422482	125,00
-----	----	-----	---	----	---	-----------------	---	---------	---------------	--------

Ø 355mm 5143R

355	30	2,6	2,2	80	-	SMTCG LaserSlit	-	B-33607	0088381422499	151,00
-----	----	-----	-----	----	---	-----------------	---	---------	---------------	--------

Discos Specialized Batería



Los discos de calidad superior están hechos especialmente para las sierras a batería.

Discos para cortar madera, ahora disponibles para las sierras circulares a batería más populares.

“Todas con la calidad Makita”.

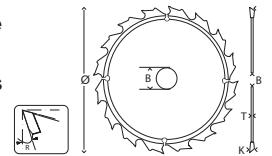

Ø 85mm HS301D

Ø ext. (mm)	Ø int. (mm)	K (mm)	T (mm)	Nº dientes	R	Tipo de diente	Reducción	Código	EAN	P.V.P (€)
85	15	1,0	0,7	20	10°	ATB	Madera	B-14607	0088381362689	9,55
85	15	0,5	0,5	50	-	-	Contrachapado	792299-8	0088381101004	13,40
85	15	0,5	0,5	50	-	-	Plástico	792259-0	0088381100816	10,30

Ø 136mm DSS501

136	20	1,5	1,0	16	20°	ATAF	Madera	B-10643	0088381347815	24,00
-----	----	-----	-----	----	-----	------	--------	---------	---------------	-------

Ø 165mm DHS660 - DHS661 - DSS610 - DHS680

165	20	1,6	1	40	18°	ATAF	Madera	B-32954	0088381421829	25,00
165	20	1,5	1	24	20°	ATAF	Madera	B-32910	0088381421782	23,00
165	20	1,4	1	25	23	Efficut	Madera	B-62979	0088381531474	29,00
165	20	1,45	1	56	23°	Efficut	Madera	B-57336	0088381518420	47,00

Ø 190mm DHS710 - DHS782 - DHS783 - HS004G

190	30	2	1,4	24	20°	ATAF	Madera	B-32926	0088381421799	21,00
190	30	2	1,4	40	10°	ATAF	Madera	B-32976	0088381421843	24,00

Ø 216mm DHS900

216	30	-	-	45	-	-	-	E-06971	0088381570725	45,00
-----	----	---	---	----	---	---	---	---------	---------------	-------

Ø 235mm DHS900 - HS009G

235	30	2,2	1,5	24	20	Efficut	Madera	E-01909	0088381337236	41,00
-----	----	-----	-----	----	----	---------	--------	---------	---------------	-------



Discos de sierra para sierras circulares

Discos Specialized Incisión



Estos discos son específicos para las sierras de incisión.

Están específicamente diseñados para conseguir un corte totalmente limpio.

Los discos para sierras de incisión tienen una tecnología patentada contra las vibraciones.

Los discos de baja vibración ejecutan el corte con menos vibraciones por lo que el disco entra más fácil en el material y con menos esfuerzo.

- La estructura del disco es de acero tensionado de precisión para mayor rigidez y cortes más rectos.
- Válido para cortar madera.

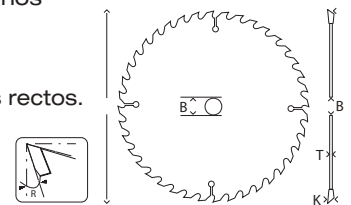

Ø 165mm DSP600 - DSP601 - SP001G - SP6000

Ø ext. (mm)	Ø int. (mm)	K (mm)	T (mm)	Nº dientes	R	Tipo de diente	Reducción	Código	EAN	P.V.P (€)
160	20	2,2	1,6	28	23°	ATB Laser slit	-	B-32982	0088381421850	29,00
165	20	2	1,4	28	15°	ATB Laser slit	-	B-56699	0088381534765	44,00
160	20	2,2	1,6	48	8°	ATB Laser slit	-	B-32998	0088381421867	35,00
165	20	2,2	1,6	48	8°	ATB Laser slit	-	B-33015	-	53,00

Especial Madera

165	20	1,85	1,25	48	8°	Corte limpio	-	B-56708	0088381534772	69,00
-----	----	------	------	----	----	--------------	---	---------	---------------	-------

Especial MDF

165	20	2,0	1,4	60	5°	Extra limpio	-	B-56720	0088381534789	57,00
-----	----	-----	-----	----	----	--------------	---	---------	---------------	-------

Especial para Corian

165	20	2,4	1,7	48	5°	TCG	-	B-10344	0088381342100	60,00
165	20	2,0	1,4	48	5°	TCG	-	B-56742	0088381534819	66,00

Especial para Aluminio

165	20	2,4	1,7	56	-3°	TCG LaserSlit	-	B-33021	-	57,00
165	20	2,0	1,4	56	-3°	TCG LaserSlit	-	B-56714	0088381534802	68,00



Discos de sierra para ingletadoras

Discos MakBlade corte silencioso



Los discos de sierra MAKBLADE PLUS para ingletadoras tienen una tecnología única y patentada. Estos discos están desarrollados para atenuar las vibraciones y el ruido. Estos discos característicos mejoran el ambiente de trabajo y mejoran la durabilidad de la hoja y la fiabilidad del conjunto con la máquina. La vida de los

dientes se alarga significativamente cuidando su carburo de tungsteno mejor que los discos convencionales.

- Menor vibración y menor ruido.

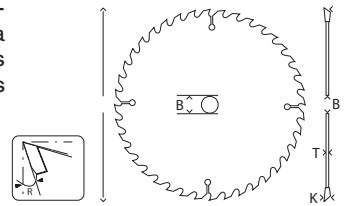

Ø 190mm DLS600 - DLS714 - LS0714F

Ø ext. (mm)	Ø int. (mm)	K (mm)	T (mm)	Nº dientes	R	Tipo de diente	Reducción	Código	EAN	P.V.P (€)
190	20	2.0	1,4	60	5°	ATAF	-	B-08757	0088381336741	45,00

Ø 250mm / 260mm DLS111 - LF1000 - LH1040F - LS004G - LS1018L - LS1019L - LS1040F

250	30	2,6	1,8	80	5°	TCG	-	B-42640	0088381440882	92,00
250	30	2,6	1,8	80	5°	HI - ATB	-	B-42662	0088381440905	92,00
250	30	3,2	2,2	80	5°	TCG	-	B-42830	0088381433969	92,00
250	30	3,2	2,2	80	5°	HI - ATB	-	B-42852	0088381433983	92,00

Ø 305mm DLS211 - LH1201FL - LS003G - LS1219L

300	30	2,6	1,8	96	-5°	HI - ATB	-	B-42678	0088381440912	103,00
300	30	3,2	2,2	96	-5°	HI - ATB	-	B-42868	0088381433990	103,00
305	30	2,5	1,9	70	0°	ATAF	-	B-32568	0088381421379	73,00



Makita

Discos MakBlade



Una extensa selección de discos para todas las marcas y modelos de ingletadoras.

Amplia gama de medidas desde 190mm hasta 305mm y de número de dientes desde 24 a 100. La gama abarca un gran número de aplicaciones desde corte grueso a corte con un acabado extra fino.

- Las sierras de acero tensionado absorben los impactos sin deformarse.
- Carburo de tungsteno de alta calidad y bajo desgaste para una larga vida de la sierra.
- Corte fino con menos viruta y menos esfuerzo en el motor.

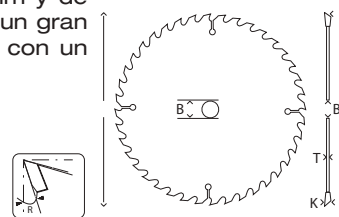

Ø 190mm DLS600 - LS0714F - DLS714

Ø ext. (mm)	Ø int. (mm)	K (mm)	T (mm)	Nº dientes	R	Tipo de diente	Reducción	Código	EAN	P.V.P (€)
190	20	2,2	1,6	24	5°	ATB	-	B-32708	0088381421515	23,00
190	20	2,2	1,6	48	5°	ATB	-	B-08953	0088381336994	33,00
190	20	2,0	1,4	60	5°	ATB	-	B-09042	0088381337083	33,00

Ø 216mm LS002G - LS0815FL

216	30	2,1	1,6	40	10°	ATB	-	A-86169	0088381150026	45,00
216	30	2,4	1,6	48	5°	ATB	-	B-32764	0088381421577	41,00
216	30	2,2	1,6	80	5°	ATB	-	A-86468	0088381150804	69,00

Ø 260mm DLS111 - LF1000 - LH1040F - LS004G - LS1018L - LS1019L - LS1040F

250	30	2,4	1,8	72	5°	ATB	-	B-33308	0088381422185	42,00
250	30	2,3	1,8	100	5°	ATB	-	B-32873	0088381421683	50,00
255	30	2,3	1,8	32	5°	ATB	-	B-32720	0088381421539	52,00
255	30	2,3	1,8	60	5°	ATB	-	B-32792	0088381421607	38,00
260	30	2,3	1,8	40	5°	ATB	-	B-32770	0088381421584	37,00
260	30	2,3	1,8	60	5°	ATB	-	B-32801	0088381421614	45,00
260	30	2,3	1,8	80	5°	ATB	-	B-32845	0088381421652	48,00
260	30	2,3	1,8	100	5°	ATB	-	B-32873	0088381421683	50,00
260	30	2,5	1,65	80	10°	Efficut	-	B-67240	0088381541015	65,00

Ø 305mm LH1201FL - LS1219L - DLS211

305	30	2,3	1,8	40	5°	ATB	-	B-32786	0088381421591	48,00
305	30	2,3	1,8	60	5°	ATB	-	B-32817	0088381421621	63,00
305	30	2,3	1,8	80	5°	ATB	-	B-32851	0088381421669	75,00
305	30	2,3	1,8	100	5°	ATB	-	B-32889	0088381421690	82,00
305	30	2,5	1,65	80	10°	Efficut	-	B-67256	0088381541022	65,00



Makita

Discos de sierra para ingletadoras

Discos Specialized Aluminio



- Chapa de precisión tensionada para mayor rigidez y cortes más rectos.
- Excelente calidad de corte en materiales no ferrosos.
- Perfecta realización del corte en suelos laminados.

Aplicar cera de discos en la zona del diente frecuentemente para prevenir la acumulación de viruta en los dientes cuando cortemos metales no ferrosos.

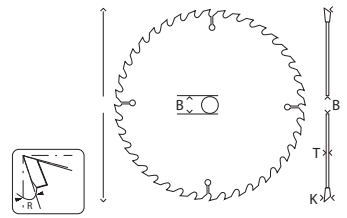

Ø 190mm DLS600 - DLS714Z - LS0714F

Ø ext. (mm)	Ø int. (mm)	K (mm)	T (mm)	Nº dientes	R	Tipo de diente	Reducción	Código	EAN	P.V.P (€)
190	20	2	1,4	60	-5°	TCG	-	B-33283	0088381422154	41,00

Ø 216mm LS0815FL - LS002G

216	30	2,2	1,6	64	-5°	TCG	-	B-33299	0088381422178	48,00
-----	----	-----	-----	----	-----	-----	---	---------	---------------	-------

Ø 260mm DLS111 - LF1000 - LH1040F - LS004G - LS1018L - LS1019L - LS1040F

250	30	2,4	1,8	100	-5°	TCG	-	B-33314	-	68,00
260	30	2,4	1,8	80	-5°	TCG	-	B-33320	0088381422208	63,00
260	30	2,4	1,8	100	-5°	TCG	-	B-33336	0088381422215	70,00
260	30			81		Efficut		E-06317	-	81,00

Ø 305mm DLS211 - LH1201FL - LS003G - LS1219L

305	30	2,4	1,8	80	-5°	TCG	-	B-33342	0088381422222	66,00
305	30	2,4	1,8	100	-5°	TCG	-	B-33358	-	92,00



Discos Specialized Standard Economy

Ø 305mm DLS211 - LH1201FL - LS003G - LS1219L

Ø ext. (mm)	Ø int. (mm)	K (mm)	T (mm)	Nº dientes	R	Tipo de diente	Reducción	Código	EAN	P.V.P (€)
305	30	-	-	60	5°	ATB	-	D-72316	0088381569040	33,00
305	30	-	-	80	5°	ATB	-	D-72322	0088381569057	37,00
305	30	-	-	100	5°	ATB	-	D-72338	0088381569064	42,00

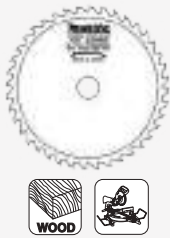

Discos Specialized Sierras de mesa - Madera



Diseñados para sierras de mesa Makita y otros fabricantes de sierras.

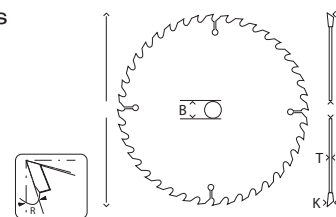

Ø 260mm 2704 y MLT100

Ø ext. (mm)	Ø int. (mm)	K (mm)	T (mm)	Nº dientes	R	Tipo de diente	Reducción	Código	EAN	P.V.P (€)
260	30	2,3	1,5	40	20°	TCG	-	B-05072	0088381200677	43,00

Ø 315mm 2712

315	30	2,8	2,0	40	16°	Corte rápido	-	JM27170001	0088381531641	31,00
-----	----	-----	-----	----	-----	--------------	---	------------	---------------	-------

Discos Specialized Sierras de mesa - Aluminio



Ø 260mm 2704 - MLT100

Ø ext. (mm)	Ø int. (mm)	K (mm)	T (mm)	Nº dientes	R	Tipo de diente	Reducción	Código	EAN	P.V.P (€)
260	30	2,8	2,2	80	0°	TCG	-	B-33386	-	71,00

Ø 300mm

300	30	2,8	2,2	80	0°	TCG	-	B-33392	0088381422277	77,00
-----	----	-----	-----	----	----	-----	---	---------	---------------	-------

Ø 350mm

350	30	3,2	2,6	100	0°	TCG	25	B-09737	0088381337779	101,00
-----	----	-----	-----	-----	----	-----	----	---------	---------------	--------

Discos Specialized laminados



- Excelente calidad de corte en suelos laminados.
- Gran precisión de corte en molduras y rodapiés.

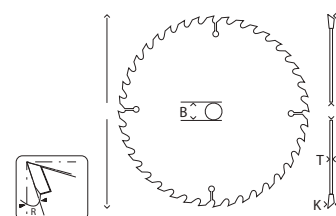

Ø 216mm LS0815FL - LS002G

Ø ext. (mm)	Ø int. (mm)	K (mm)	T (mm)	Nº dientes	R	Tipo de diente	Reducción	Código	EAN	P.V.P (€)
216	30	2,5	1,8	72	5	TCG	-	B-33853	0088381422703	103,00

Ø 260mm DLS111 - LF1000 - LH1040F - LS004G - LS1018L - LS1019L - LS1040F

260	30	2,5	1,8	84	5	TCG	-	B-29496	0088381416641	95,00
-----	----	-----	-----	----	---	-----	---	---------	---------------	-------

Ø 305mm DLS211 - LH1201FL - LS003G - LS1219L

305	30	2,5	1,8	96	5	TCG	-	B-33881	0088381422734	157,00
-----	----	-----	-----	----	---	-----	---	---------	---------------	--------

Discos Specialized Fresado CA5000

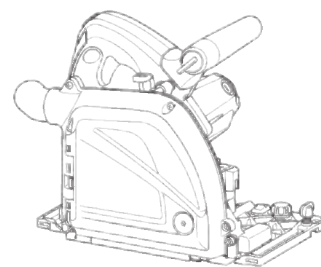

Ø 118mm - CA5000

Ø ext. (mm)	Ø int. (mm)	K (mm)	T (mm)	Nº dientes	R	Material	Reducción	Código	EAN	P.V.P (€)
118	20	14	6	6	90°	Aluminio composite	-	B-48832	0088381458733	166,00
118	20	18	6	6	135°	Aluminio composite	-	B-48860	0088381458740	183,00

Cuchillas de corte DSC102 / SC103D



Tipo	Código	EAN	P.V.P (€)
M6	199087-8	0088381524766	68,00
M8	199085-2	0088381524759	68,00
M10	199083-6	0088381524742	68,00

Disco de corte CP100D



Código	EAN	P.V.P (€)
198603-3	0088381487344	9,40

Disco de corte DSC250



Ø 110mm - DSC250 - DSC251

Ø ext. (mm)	Ø int. (mm)	K (mm)	T (mm)	Nº dientes	R	Tipo de diente	Reducción	Código	EAN	P.V.P (€)
110	15	-	-	24	0°	SMTCG	-	E-11097	0088381581752	67,00



Discos de sierra para cortadoras de metal

Discos Specialized - Corte de metal

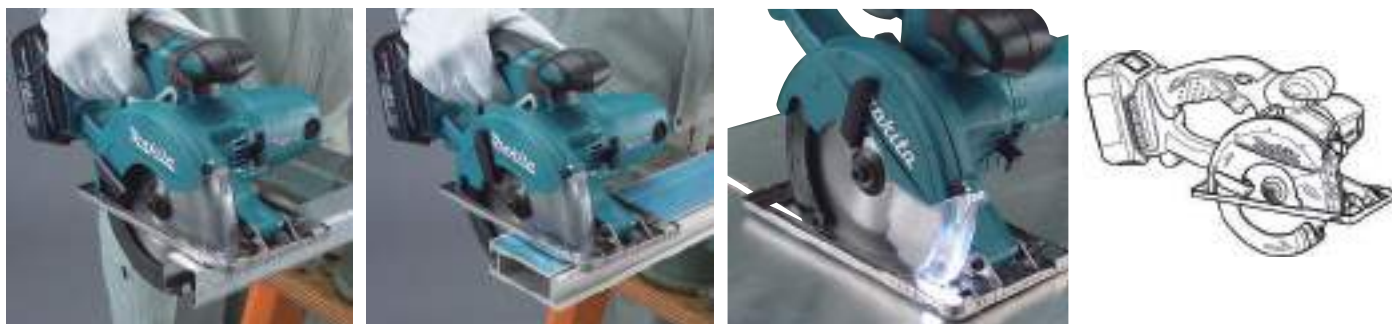

Ø 136mm DCS550

Ø ext. (mm)	Ø int. (mm)	K (mm)	T (mm)	Nº dientes	Tipo	Tipo de diente	Reducción	Código	EAN	P.V.P (€)
136	20	1,5	1,2	30	-	SMTCG	Metal	B-10615	0088381346689	44,00
136	20	1,4	1,0	50	-	SMTCG	Chapa fina	B-07325	0088381312813	44,00
136	20	1,1	0,95	56	-	SMTCG	Inox	B-23086	0088381406239	73,00



Ø 150mm DCS551 - DCS553

150	20	1,5	1,2	32	-	SMTCG	Metal	B-47036	-	41,00
150	20	1,4	1,1	52	-	SMTCG	Chapa fina	B-47042	-	57,00
150	20	1,1	0,95	60	-	SMTCG	Inox	B-47058	-	62,00
150	20	1,6	1	52	-	SMTCG	Aluminio	B-47064	-	57,00

Ø 185mm 4131

Ø ext. (mm)	Ø int. (mm)	K (mm)	T (mm)	Nº dientes	Tipo	Tipo de diente	Reducción	Código	EAN	P.V.P (€)
185	30	1,7	1,3	70	-	HM	Acero	B-33445	-	53,00
185	30	2	1,6	48	-	HM	Acero	B-33451	-	52,00
185	30	2	1,6	38	-	HM	Acero	B-33423	-	47,00
185	30	1,9	1,5	36	-	Cermet	Acero	B-33417	-	65,00



Ø 305mm LC1230

305	25,4	2,1	1,7	60	-	HM	Acero	B-33439	-	115,00
305	25,4	2,3	2	78	-	HM	Acero Suave	B-33467	-	139,00
305	25,4	1,95	1,95	76	-	HM	Inox	A-87579	0088381160445	237,00
305	25,4	2,4	1,5	100	Silencioso	HM	Inox	B-33750	-	283,00



Discos de HM para LC1230











Ø (mm)	Nº de dientes	Código
305	HM60	B-33439
	HM78	B-33467
	HM76	A-87579
	HM100	B-33750

Discos de HM para 4131



Ø (mm)	Nº de dientes	Código
185	HM70	B-33445
	HM48	B-33451
	HM38	B-33423
	Cermet 36	B-33417

Código	B-33439	B-33467	A-87579	B-33750
Ø (mm.)	305 x 25,4			
Nº dientes	HM60	HM78	HM76	HM100
Material	Acero	Acero suave fino	Inox	Inox
 3 mm.	△	⊙	○	○
 4 - 6 mm.	⊙	○	○	○
 7 mm. -	○	×	○	○
 1,2 - 3 mm.	△	⊙	○	○
 3 - 5 mm.	⊙	○	○	○
 2 - 4 mm.	△	⊙	○	○
 4 mm. -	⊙	○	○	○
 Inox 1,2 - 3 mm.	×	×	⊙	⊙

Código	B-09771	B-33451	B-33423	B-33417
Ø (mm.)	185x30x2	185x30x2	185x30x2	185x30x1,9
Nº dientes	HM70 (-10°)	HM48 (0°)	HM38 (0°)	*Cermet36 (0°)
Cuadrado de hierro	50 x 50 x 4 mm.	×	△	○
	50 x 50 x 4 mm.	×	○	△
	50 x 50 x 6 mm.	×	○	⊙
	50 x 100 x 3,2 mm.	×	○	⊙
Acero en planchas	0,9 x 500 mm.	⊙	○	△
	3,0 x 500 mm.	△	○	⊙
Perfiles en U	50 x 100 x 1,6 mm.	×	○	△
	45 x 90 x 3,2 mm.	×	○	⊙
Angulo	50 x 50 x 4 mm.	×	△	○
	50 x 50 x 6 mm.	×	○	⊙
Tubos de acero templado	Ø 25 x 1,2 mm.	×	⊙	⊙
Tubos metálicos	Ø 60 x 4 mm.	×	△	○
Varilla	Ø 20 mm.	×	△	○
Perfiles de tabiquería seca	1 mm.	⊙	×	×
	1 - 2 mm.	×	⊙	△
Chapa ondulada (pegaso)	0,9 mm.	⊙	×	×
	1 - 2 mm.	△	△	×



- ⊙ Disco ideal.
- Disco válido.
- △ Disco no recomendado.
- × Disco muy desaconsejado.

Guías de carril y accesorios



Pieza para unir dos carriles



Guía carril



Funda para carril guía

Descripción	Longitud (m)	Unds.	Código	EAN	P.V.P (€)
Pieza para unir dos carriles	-	1	198885-7	0088381497046	25,00
Guía carril	1	1	199140-0	0088381528672	45,00
	1,4	1	194368-5	0088381313353	71,00
	1,9	1	194925-9	0088381354790	109,00
	3	1	194367-7	0088381335201	185,00
Funda para carril guía	1	1	E-05670	0088381567183	46,00
	1,4	1	E-05664	0088381567176	53,00
	1,9	1	E-10920	0088381581523	83,00
	3	1	E-10936	0088381581530	103,00

Soportes de guía de carril

A



192505-5

B



192506-3 y 192507-1

C

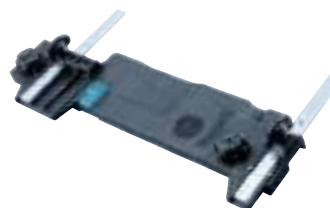

197252-3

D



199232-5



Guía de ángulos



Unds.	Código	EAN	P.V.P (€)
1	196664-7	0088381438414	39,00

Modelos	Imagen	Unds.	Código	EAN	P.V.P (€)
5603R 5705R	A	1	192505-5	0088381131919	29,00
5903R	B	1	192506-3	0088381132190	114,00
5103R	B	1	192507-1	0088381132206	85,00
HS6100 HS7100 HS7101 DHS710	C	1	197252-3	0088381453790	66,00
HS0600	C	1	198570-2	0088381495912	215,00
HS6601	C	1	197462-2	0088381523837	27,00
HS7601 HS7611	C	1	197005-0	0088381484602	65,00
DHS680	C	1	196953-0	0088381463751	52,00
DHS660	D	1	199232-5	0088381529334	52,00

Repuestos para guías de carril

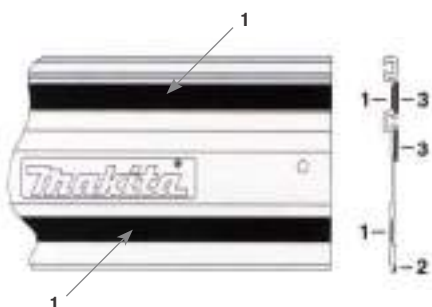

Descripción	Longitud	Número	Unds.	Código	EAN	P.V.P (€)
Goma deslizante	1,4	1	1	413101-9	3240890284549	4,10
	1,9		1	451330-6	-	6,20
	3,0		1	413102-7	3240890284488	15,45
Goma antiaspillas	1,4	2	1	423359-2	3240890283870	5,65
	1,9		1	423386-9	-	8,25
	3,0		1	423360-7	3240890284136	11,00
Goma antideslizante	1,4	3	1	423361-5	3240890282088	6,70
	1,9		1	423390-8	-	9,25
	3,0		1	423362-3	3240890281838	15,45

Mordaza para carril guía



Modelos	Unds.	Código	EAN	P.V.P (€)
Guías de carril	2	194385-5	0088381314084	28,00

Guía paralela

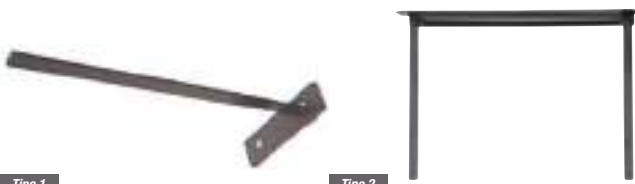

Tipo 1

Tipo 2

Modelos	Tipo	Unds.	Código	EAN	P.V.P (€)
HS301	1	1	195333-7	-	3,05
5604R 5704R HS5100 HS7100 HS7101 HS7601		1	164095-8	0088381101080	1,80
5017RKB 5603R 5703R 5705R		1	165108-8	0088381141376	6,45
5903R 5103R		1	165084-6	0088381152464	4,20
5143R		1	152498-8	0088381156295	47,00
DSP600 DSP601 SP6000	2	1	165447-6	0088381347587	15,85

Placa guía para CA5000

- Marca la línea de fresado.



Modelos	Unds.	Código	EAN	P.V.P (€)
CA5000	1	143396-7	-	4,10

Ganchos



Modelos	Unds.	Código	EAN	P.V.P (€)
DHS780	1	199386-8	0088381534963	15,65
DHS660	1	199231-7	0088381532839	8,85

Mesa para ingletadoras



194043-3



DEAWST05



DEAWST06
DEAWST07

	Largo (mm)	Alto (mm)	Ancho (mm)	Modelos	Unds.	Código	EAN	P.V.P (€)
	762	841	743	LS0714F LH1040F LS1019L LS1018L LS1040F LS1219L LH1201FL	1	198688-9	0088381488938	187,00
	2.700	500	800	Todos los modelos	1	DEAWST05	0088381424318	326,00
	2.550	750	850		1	DEBWST06		297,00
	3.830	860	750	Válida para todos los modelos a excepción de DLS600, LH1040/F y LH1201FL.	1	DEAWST07		407,00

Mesas para sierras de mesa



194093-8

JM27000300

Modelos	Unds.	Código	EAN	P.V.P (€)
2704	1	194093-8	0088381205702	350,00
MLT100	1	JM27000300	0088381351003	257,00



Extensión de soporte



Modelos	Tipo	Unds.	Código	EAN	P.V.P (€)
LH1040 LS1040 LS0714F MLS100	Pie	1	122446-1	0088381156158	27,00
-	Barras	1	256812-1	0088381146517	24,00

Topes para cortes de molduras



Modelos	Unds.	Código	EAN	P.V.P (€)
LS003G LS004G LS1019L LS1219L	2	192628-9	0088381141710	40,00
LS1016/L	2	192669-5	0088381146470	71,00

Rodillo auxiliar



Largo (mm)	Altura regulable (mm)	Unds.	Código	EAN	P.V.P (€)
250	47 - 140	1	A-47450	0088381289535	102,00

Soportes laterales



Tope de apoyo



Modelos	Unds.	Código	EAN	P.V.P (€)
LS1013F/FLB LS1214F/L	1	194002-7	0088381193795	56,00

Modelos	Unds.	Código	EAN	P.V.P (€)
LS0810	1	164806-1	0088381162517	7,70
LS1013F/FLB LS1214F/L	1	322932-4	0088381141673	6,50
LH1040F LS1040F	1	123101-8	0088381538244	14,95
LS1440	2 + Tope ajustable	191239-7	008838112093	28,00
MLS100	1	JM23000127	0088381347907	9,25
LS1016/L LS1216/FLB	2	195240-4	0088381366250	9,00
LH1200FL	1	JM23100500	0088381373623	10,70
LS1019L LS1219L	1	327095-1	-	5,50

Mordazas para ingletadoras

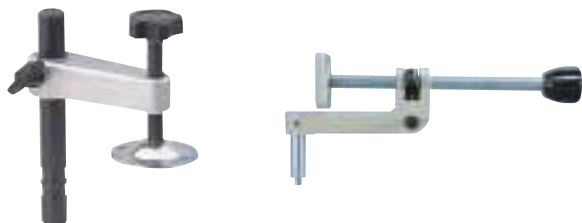

Vertical

Horizontal

Modelos	Tipo	Unds.	Código	EAN	P.V.P (€)
LS0714F BLS713RFE	Vertical	1	122571-8	0088381151863	21,90
LS0815		1	JM23510009	0088381447331	10,30
LS1013 LS1214		1	122538-6	0088381141697	18,55
LH1040F LS1040F		1	192625-5	0088381150729	19,00
LS1016/L LS1216/FL		1	122854-6	0088381356619	25,00
LF1000		1	122728-1	0088381288484	16,50
LS1018 LH1200FL		1	JM23100502	0088381373661	6,10
LS1019L LS1219L		1	126617-2	-	28,00
MLS100		1	JM23000131	0088381347938	7,70
LS0714F LS1040 LH1040		Horizontal	1	122567-9	0088381151573
LS1013 LS1214 LS1016/L LS1019L LS1219L	1		122470-4	0088381142625	85,00
LS1216/FLB LH1200FL LS1018L	1		122930-6	0088381366274	74,00

Guías paralelas



Modelos	Unds.	Código	EAN	P.V.P (€)
2704	1	122739-6	0088381277020	116,00
LH1040F	1	122707-9	0088381195386	16,10
LF1000	1	122729-9	0088381288460	27,00
LH1201FL	1	JM23300008	3240890401823	52,00
2712	1	JM27110005	-	37,00

Botón de seguridad



Modelos	Unds.	Código	EAN	P.V.P (€)
Todos los modelos	1	417113-4	-	0,60

Arnés para DLS600



Modelos	Unds.	Código	EAN	P.V.P (€)
DLS600	1	166058-0	0088381494953	10,80

Guías de ingletes



Modelos	Unds.	Código	EAN	P.V.P (€)
2704N	1	127069-0	-	46,00
LF1000	1	122730-4	0088381288477	15,45

Extensiones para 2704

Extensión trasera

Extensión izquierda



Descripción	Unds.	Código	EAN	P.V.P (€)
Extensión trasera	1	194087-3	0088381200301	41,00
Extensión izquierda	1	194086-5	0088381200295	34,00

Topes ajustables



Modelos	Unds.	Código	EAN	P.V.P (€)
LH1040 LS0714 LS1040	1	122472-0	0088381155892	5,15
MLS100	1	JM23000128	0088381347914	0,75

Lámpara



Modelos	Unds.	Código	EAN	P.V.P (€)
LS0714F LS1013F LS1214F LS1040F	1	193730-1	0088381160353	3,80

Arandela de reducción



Ø Interior (mm)	Ø Exterior (mm)	Unds.	Código	EAN	P.V.P (€)
15,88	25	1	257022-3	0088381189293	0,80
15,88	25,4	1	257060-5	0088381189309	1,30
15,88	30	1	257262-3	-	0,80

Bolsa y cajón recoge polvo



122852-0



194175-6

Palo de empuje



Unds.	Código	EAN	P.V.P (€)
1	416772-1	0088381149426	4,05



Descripción	Modelo	Unds.	Código	EAN	P.V.P (€)
Bolsa	LS1018 LH1201FL	1	JM23100501	0088381373654	3,45
Bolsa	LS0810	1	122351-2	0088381115537	7,95
Bolsa	LS0815		JM23510010	0088381447348	6,70
Bolsa	LS1440	1	122330-0	0088381115544	14,95
Bolsa	LH1040 LS1214 LS1040 LS1016/L LS11019L LS1219L LS1216/FLB	1	122852-0	0088381356602	3,55
Cajón	Modelos FLB	1	194175-6	0088381349994	37,00

Sierras de sable



Gama de sierras de sable Makita con motor BL sin escobillas y tecnología XPT.



Símbolos

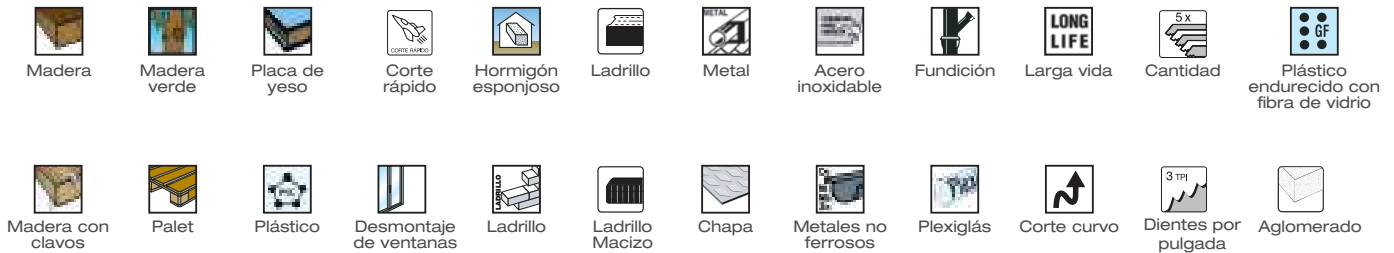

Tipo de dentado

Tipo A

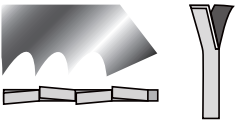

- Dentado: afilado triscado, cortes rápidos en maderas duras y blandas, aluminio, plásticos y metales no ferrosos.

Tipo B

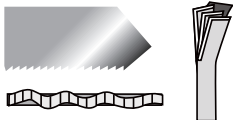

- Dentado: afilado ondulado, corte fino y limpio en madera, acero blando, aluminio y metales no ferrosos.

Tipo C

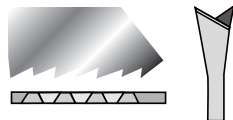

- Dentado: afilado trapezoidal, cortes finos y limpios en madera y plásticos.

Tipo C

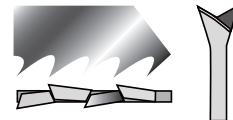

- Dentado: afilado triscado trapezoidal, cortes gruesos y rápidos en madera.

Sierras de sable

Metal



Características	Tipo	Tipo de dientes	Dientes / pulgada	Largo (mm)	Ancho (mm)	Unds.	Código	EAN	P.V.P. (€)
Para corte de acero, inoxidable y metales no ferrosos entre 3,5mm y 5mm. (El color de la hoja puede variar - azul o blanca).	BiM	B	10 / 14	305	0,9	5	B-16857	0088381367554	20,10
				225			P-47008	0088381977432	19,25
				152			P-46997	0088381977425	15,00



Características	Tipo	Tipo de dientes	Dientes / pulgada	Largo (mm)	Ancho (mm)	Unds.	Código	EAN	P.V.P. (€)
Para corte de metal de 4mm a 12mm. Corte rápido.	BiM	B	8 / 10	305	0,9	5	B-43212	0088381443081	24,00
				225			B-43181	0088381443050	21,00
				152			B-43147	0088381443012	17,25



Características	Tipo	Tipo de dientes	Dientes / pulgada	Largo (mm)	Ancho (mm)	Unds.	Código	EAN	P.V.P. (€)
Diente en M para el corte rápido de acero, inoxidable y metales no ferrosos. Corta en las dos direcciones para aumentar la velocidad de corte.	BiM	M	M	260	0,9	5	P-45727	0088381976169	25,00
				200			P-45711	0088381976152	20,85
				150			P-45705	0088381976145	17,10



Características	Tipo	Tipo de dientes	Dientes / pulgada	Largo (mm)	Ancho (mm)	Unds.	Código	EAN	P.V.P. (€)
Chapa gruesa. 4-12mm, tubo <100mm.	TC	-	8	152	1,25	1	B-55572	0088381483575	17,50
Chapa gruesa. 4-12 mm, tubo <175 mm.	TC	-	8	228	1,25	1	B-55588	0088381483582	21,00
Chapa gruesa. 4-12 mm, tubo <250 mm.	TC	-	8	305	1,25	1	B-55594	0088381483599	27,00

Metal



Características	Tipo	Tipo de dientes	Dientes / pulgada	Largo (mm)	Ancho (mm)	Unds.	Código	EAN	P.V.P. (€)
Para corte de chapa menor a 1,2mm.	BiM	B	32	150	0,9	5	P-04955	0088381914109	15,50



Características	Tipo	Tipo de dientes	Dientes / pulgada	Largo (mm)	Ancho (mm)	Unds.	Código	EAN	P.V.P. (€)
Para corte de chapa mayor a 1,2mm. (El color de la hoja puede variar - azul o blanca).	BiM	B	24	225	0,9	5	B-43169	0088381443036	17,50
				152			B-16835	0088381367530	11,85
				100			P-04896	0088381914048	13,90



Características	Tipo	Tipo de dientes	Dientes / pulgada	Largo (mm)	Ancho (mm)	Unds.	Código	EAN	P.V.P. (€)
Para corte de acero e inoxidable entre 1,5mm y 2,5mm. (El color de la hoja puede variar - azul o blanca).	BiM	B	12	225	0,9	5	B-16776	0088381367479	16,50
				152			B-05169	0088381204224	12,90
				100			P-04874	0088381914024	13,90



Características	Tipo	Tipo de dientes	Dientes / pulgada	Largo (mm)	Ancho (mm)	Unds.	Código	EAN	P.V.P. (€)
Para corte de metal de 3mm a 8mm.	BiM	B	14 / 18	305	1,1	5	B-43206	0088381443074	24,00
				225			B-43175	0088381443043	21,00
				152			B-43131	0088381443005	16,50



Características	Tipo	Tipo de dientes	Dientes / pulgada	Largo (mm)	Ancho (mm)	Unds.	Código	EAN	P.V.P. (€)
Para corte de acero e inoxidable entre 1,5mm y 2,5mm.	BiM	B	18	225	0,9	5	B-16782	0088381367486	16,50
				152			B-16841	0088381367547	11,85



Características	Tipo	Tipo de dientes	Dientes / pulgada	Largo (mm)	Ancho (mm)	Unds.	Código	EAN	P.V.P. (€)
Para corte de metal de 2mm a 10mm. Corte fino.	BiM	B	10 / 14	305	1,25	5	B-43228	0088381443098	24,00
				225			B-43197	0088381443067	21,00
				152			B-43153	0088381443029	16,50

Madera



Características	Tipo	Tipo de dientes	Dientes / pulgada	Largo (mm)	Ancho (mm)	Unds.	Código	EAN	P.V.P. (€)
Para toda clase de maderas con un acabado fino.	HCS	A	10	152	1,05	5	B-16807	0088381367509	9,00



Características	Tipo	Tipo de dientes	Dientes / pulgada	Largo (mm)	Ancho (mm)	Unds.	Código	EAN	P.V.P. (€)
Hoja gruesa para cortes rápidos en madera, plásticos y placas de yeso.	HCS	A	6	305	1,25	5	B-16829	0088381367523	14,95



Características	Tipo	Tipo de dientes	Dientes / pulgada	Largo (mm)	Ancho (mm)	Unds.	Código	EAN	P.V.P. (€)
Hoja gruesa para cortes rápidos en madera, plásticos y placas de yeso.	HCS	A	6	225	1,27	5	P-47092	0088381977524	13,90



Características	Tipo	Tipo de dientes	Dientes / pulgada	Largo (mm)	Ancho (mm)	Unds.	Código	EAN	P.V.P. (€)
Hoja gruesa para cortes rápidos en madera, plásticos y placas de yeso.	HCS	C	6	150	1,27	5	P-47086	0088381977517	12,85



Características	Tipo	Tipo de dientes	Dientes / pulgada	Largo (mm)	Ancho (mm)	Unds.	Código	EAN	P.V.P. (€)
Hoja gruesa para cortes rápidos en madera, plásticos y placas de yeso.	BIM	A	6	150	1,27	5	P-05088	0088381914314	20,35



Características	Tipo	Tipo de dientes	Dientes / pulgada	Largo (mm)	Ancho (mm)	Unds.	Código	EAN	P.V.P. (€)
Hoja especial para madera verde	HCS/CV	C	5	305	1,5	5	B-16863	0088381367561	19,05



Características	Tipo	Tipo de dientes	Dientes / pulgada	Largo (mm)	Ancho (mm)	Unds.	Código	EAN	P.V.P. (€)
Hoja especial para madera verde	HCS/CV	C	4 - 5	240	1,27	5	P-47117	0088381977548	15,50



Características	Tipo	Tipo de dientes	Dientes / pulgada	Largo (mm)	Ancho (mm)	Unds.	Código	EAN	P.V.P. (€)
Para corte curvo en madera y plástico.	HCS/CV	C	6	152	1,27	5	B-16798	0088381367493	9,00

Madera

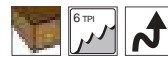

Características	Tipo	Tipo de dientes	Dientes / pulgada	Largo (mm)	Ancho (mm)	Unds.	Código	EAN	P.V.P. (€)
Para corte curvo y limpio en madera, plástico y plexiglás.	HCS	D	6	150	1,8	5	P-47101	0088381977531	19,25

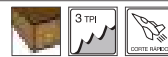

Características	Tipo	Tipo de dientes	Dientes / pulgada	Largo (mm)	Ancho (mm)	Unds.	Código	EAN	P.V.P. (€)
Hoja gruesa para cortes rápidos en madera, plásticos y placas de yeso.	HCS	A	3	152	1,25	5	B-16813	0088381367516	9,00



Características	Tipo	Tipo de dientes	Dientes / pulgada	Largo (mm)	Ancho (mm)	Unds.	Código	EAN	P.V.P. (€)
Dentado muy grueso para cortes rápidos y agresivos en maderas húmedas.	HCS	C	3	240	1,27	5	P-47123	0088381977555	16,60

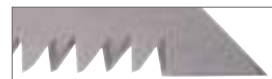

Características	Tipo	Tipo de dientes	Dientes / pulgada	Largo (mm)	Ancho (mm)	Unds.	Código	EAN	P.V.P. (€)
Dentado muy grueso para cortes rápidos y agresivos en maderas húmedas.	HCS	D	8,5	250	1,0	1	B-62016	0088381528719	15,45

S-EXPRESS



Características	Tipo	Tipo de dientes	Dientes / pulgada	Largo (mm)	Ancho (mm)	Unds.	Código	EAN	P.V.P. (€)
Hoja superexpress con un gran rendimiento en las sierras de sable a batería: Metal.	BiM	-	7 - 18	152	-	5	B-05038	0088381200592	16,50

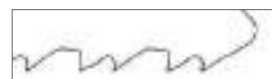

Características	Tipo	Tipo de dientes	Dientes / pulgada	Largo (mm)	Ancho (mm)	Unds.	Código	EAN	P.V.P. (€)
Hoja superexpress con un gran rendimiento en las sierras de sable a batería: Universal.	BiM	-	6 - 11	152	-	5	B-05044	0088381200608	14,40



Características	Tipo	Tipo de dientes	Dientes / pulgada	Largo (mm)	Ancho (mm)	Unds.	Código	EAN	P.V.P. (€)
Hoja superexpress con un gran rendimiento en las sierras de sable a batería: Madera.	BiM	-	6 - 10	203	-	5	B-05153	0088381200943	14,95

Madera + Metal



Características	Tipo	Tipo de dientes	Dientes / pulgada	Largo (mm)	Ancho (mm)	Unds.	Código	EAN	P.V.P. (€)
Especial Palet	BIM	B	10	180	0,9	200	B-54265	0088381477307	385,00



Características	Tipo	Tipo de dientes	Dientes / pulgada	Largo (mm)	Ancho (mm)	Unds.	Código	EAN	P.V.P. (€)
Especial para la reparación de palets. Para corte de madera con residuos metálicos. Hoja gruesa.	BIM	A	8/10	150	1,27	5	P-47064	0088381977494	18,55

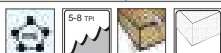

Características	Tipo	Tipo de dientes	Dientes / pulgada	Largo (mm)	Ancho (mm)	Unds.	Código	EAN	P.V.P. (€)
Madera con clavo, pvc, demolición.	BiM	-	5/8	305	1,6	5	B-43278	0088381443142	30,00
	BiM	-	5/8	225	1,6	5	B-43256	0088381443128	26,00
	BiM	-	5/8	152	1,6	5	B-43234	0088381443104	21,00



Características	Tipo	Tipo de dientes	Dientes / pulgada	Largo (mm)	Ancho (mm)	Unds.	Código	EAN	P.V.P. (€)
Diente en M para el corte rápido de madera y madera con clavo. Corta en las dos direcciones para aumentar la velocidad de corte.	BiM	A	6	152	1,25	5	B-05175	0088381204231	14,95



Características	Tipo	Tipo de dientes	Dientes / pulgada	Largo (mm)	Ancho (mm)	Unds.	Código	EAN	P.V.P. (€)
Diente en M para el corte rápido de madera y madera con clavo. Corta en las dos direcciones para aumentar la velocidad de corte.	BiM	M	-	200	0,9	5	P-45696	0088381976138	20,85
	BiM	M	-	150	0,9	5	P-45680	0088381976121	17,10



Madera + Metal



Características	Tipo	Tipo de dientes	Dientes / pulgada	Largo (mm)	Ancho (mm)	Unds.	Código	EAN	P.V.P. (€)
Especial para la reparación de palets. Para corte de madera con residuos metálicos. Hoja gruesa.	BiM	A	10 / 14	225	1,27	5	P-47195	0088381977623	19,80
	BiM	A	10 / 14	150	1,27	5	P-47189	0088381977616	15,00



Características	Tipo	Tipo de dientes	Dientes / pulgada	Largo (mm)	Ancho (mm)	Unds.	Código	EAN	P.V.P. (€)
Especial para la reparación de palets. Para corte de madera con residuos metálicos. Hoja fina.	BiM	A	10 / 14	280	0,9	5	P-67767	0088381998291	24,00
	BiM	A	10 / 14	152	0,9	5	P-47014	0088381977449	14,40



Características	Tipo	Tipo de dientes	Dientes / pulgada	Largo (mm)	Ancho (mm)	Unds.	Código	EAN	P.V.P. (€)
Especial palet. Madera con clavo, PVC y aluminio.	BiM	B	10 / 14	225	0,9	5	B-43262	0088381443135	17,50
	BiM	B	10 / 14	152	0,9	5	B-43240	0088381443111	12,90

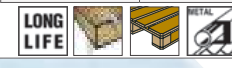

Características	Tipo	Tipo de dientes	Dientes / pulgada	Largo (mm)	Ancho (mm)	Unds.	Código	EAN	P.V.P. (€)
Especial palet, madera con clavo, aluminio.	BiM	B	10	225	0,9	5	B-31859	0088381420129	17,50
	BiM	B	10	152	0,9	5	B-31843	0088381420112	12,90



ESPECIALES

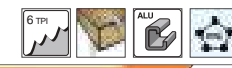

Características	Tipo	Tipo de dientes	Dientes / pulgada	Largo (mm)	Ancho (mm)	Unds.	Código	EAN	P.V.P. (€)
Sierra de sable de rescate 152x125 mm 6-8 TPI. Recomendada para situaciones de rescate.	TC / HM	-	6-8	152	1,25	25	B-67206	0088381540759	271,00

ESPECIALES



Características	Tipo	Tipo de dientes	Dientes / pulgada	Largo (mm)	Ancho (mm)	Unds.	Código	EAN	P.V.P. (€)
Ideal para maderas duras, hormigón esponjoso, eternita y plásticos reforzados con fibra de vidrio y epoxy. Dientes de carburo de tungsteno	HM	A	3	400	1,3	1	P-05066	0088381914215	46,00
	HM	A	6	300	1,3	-	P-05050	0088381914208	51,00
				150			P-05044	0088381914192	24,00
				100			P-05038	0088381914185	20,85



Características	Tipo	Tipo de dientes	Dientes / pulgada	Largo (mm)	Ancho (mm)	Unds.	Código	EAN	P.V.P. (€)
Especial para ladrillo.	HM	-	2	400	-	1	B-10403	0088381342667	47,00
				265			B-10394	0088381342650	34,00



Características	Tipo	Tipo de dientes	Dientes / pulgada	Largo (mm)	Ancho (mm)	Unds.	Código	EAN	P.V.P. (€)
Especial para ladrillo hueco.	HM - TC	-	2	240	-	1	B-12809	0088381355544	26,00



Características	Tipo	Tipo de dientes	Dientes / pulgada	Largo (mm)	Ancho (mm)	Unds.	Código	EAN	P.V.P. (€)
Para cortes en cerámica, hierro de fundición, ladrillo muy duro y plásticos reforzados con fibra de vidrio y epoxy.	CV-HM	-	-	180	1,05	2	P-47173	0088381977609	16,05



Características	Tipo	Tipo de dientes	Dientes / pulgada	Largo (mm)	Ancho (mm)	Unds.	Código	EAN	P.V.P. (€)
Especial para productos congelados. Hoja de acero inoxidable sin pinturas.	INOX	-	6	152	-	1	B-52043	0088381467544	22,00
		A		250			B-10609	0088381346641	9,55
		-		228			B-30564	0088381418607	22,00

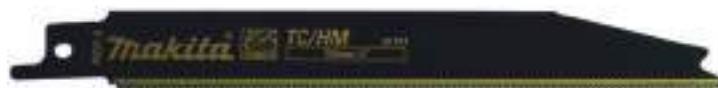

Características	Tipo	Tipo de dientes	Dientes / pulgada	Largo (mm)	Ancho (mm)	Unds.	Código	EAN	P.V.P. (€)
Especial para corte en inoxidable.	HN	-	18	152	-	2	B-07250	0088381310734	30,00



Características	Tipo	Tipo de dientes	Dientes / pulgada	Largo (mm)	Ancho (mm)	Unds.	Código	EAN	P.V.P. (€)
Fibrocemento / Ladrillo 10-250mm epoxy 6-150mm	TC / HM	-	3	305	1,5	2	B-63585	0088381532846	40,00



Características	Tipo	Tipo de dientes	Dientes / pulgada	Largo (mm)	Ancho (mm)	Unds.	Código	EAN	P.V.P. (€)
Fibrocemento / Ladrillo 20-350mm epoxy 6-150mm	TC / HM	-	2	400	1,5	2	B-63591	0088381532853	48,00

Para sierra de sable JR100D - DJR183



Características	Tipo	Tipo de dientes	Dientes / pulgada	Largo (mm)	Ancho (mm)	Unds.	Código	EAN	P.V.P. (€)
Metal	BiM	-	24	100	0,7 - 3,0	5	B-20395	0088381375986	11,35



Características	Tipo	Tipo de dientes	Dientes / pulgada	Largo (mm)	Ancho (mm)	Unds.	Código	EAN	P.V.P. (€)
Metal	BiM	-	18	100	1,5 - 4,0	5	B-20404	0088381375993	11,35



Características	Tipo	Tipo de dientes	Dientes / pulgada	Largo (mm)	Ancho (mm)	Unds.	Código	EAN	P.V.P. (€)
Metal	BiM	-	14	100	3,0 - 8,0	5	B-20410	0088381376006	11,35



Características	Tipo	Tipo de dientes	Dientes por pulgada	Largo total (mm)	Ancho (mm)	Unds.	Código	EAN	P.V.P. (€)
Madera - metal	BiM	-	10	100	Metal 3,0 - 12 / Madera 10 - 50	5	B-20426	0088381376013	11,35



Características	Tipo	Tipo de dientes	Dientes / pulgada	Largo (mm)	Ancho (mm)	Unds.	Código	EAN	P.V.P. (€)
Madera con clavo	BiM	-	6	100	10 - 50	5	B-20432	0088381376020	11,35



Características	Tipo	Tipo de dientes	Dientes / pulgada	Largo (mm)	Ancho (mm)	Unds.	Código	EAN	P.V.P. (€)
Tableros de fibra	BiM	-	6	100	5,0 - 50	5	B-20448	0088381376037	11,35



Características	Tipo	Tipo de dientes	Dientes / pulgada	Largo (mm)	Ancho (mm)	Unds.	Código	EAN	P.V.P. (€)
Madera - metal	BiM	-	14 / 18	100	Metal 3,0 - 8,0 / Madera 10 - 50	5	B-20454	0088381376044	11,35



Hojas para 2107FK / 2107FXK (13 mm. x 0,5 mm. x 1.140 mm.)

Corte METAL



P. no F. / Metal	A.B. / Arrabio	Velocidad		Espesor (mm)	Material	Dientes por pulgada	Unds.	Código	EAN	P.V.P. (€)
		Alta	Baja							
1	2	1	2	0,5	Acero al carbono	14	3	792560-3	008838117517	37,00
1	2	1	2	0,5		18	3	792559-8	008838117524	37,00
1	2	1	2	0,5		24	3	792558-0	008838117531	37,00
1	2	1	2	0,5	Bi-Metal	14HSS	1	194691-8	0088381350808	21,00
1	2	1	2	0,5		18HSS	1	792556-4	008838117555	23,00
1	2	1	2	0,5		24HSS	1	194692-6	0088381350815	21,00

Corte MADERA

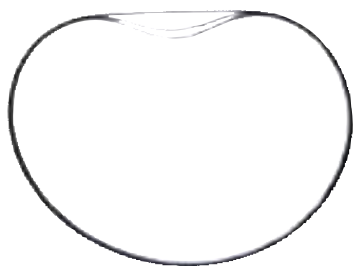

Madera		Velocidad		Espesor (mm)	Material	Dientes por pulgada	Unds.	Código	EAN	P.V.P. (€)
Con clavo	Sin clavo	Alta	Baja							
1	1	1	-	0,5	Acero al carbono	6	3	792567-9	008838117579	37,00

Sierras de cinta para LB1200F (2.240mm)



Aplicación	Material	Espesor (mm)	Dientes por pulgada	Ancho de la hoja (mm)	Unds.	Código	EAN	P.V.P. (€)
Madera corte transversal	Acero al carbono	0,5	4	16	3	B-16667	0088381366731	56,00
Madera corte universal		0,5	4	13	3	B-16673	0088381366748	47,00
Madera corte curvo		0,5	6	6	3	B-16689	0088381366755	46,00
Metales no ferrosos		0,5	14	16	3	B-16695	0088381366762	62,00

Sierras de cinta para DPB181 - DPB182 - DPB183 (835mm)

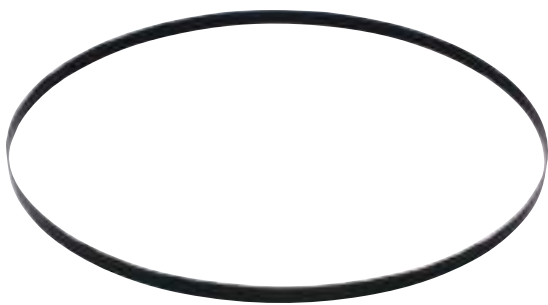

Aplicación	Material	Espesor	Dientes por pulgada	Ancho de la hoja (mm)	Unds.	Código	EAN	P.V.P. (€)
Plásticos, metales no ferrosos, hierro, inoxidable	Bi-Metal	0,5	14	13	5	B-40543	0088381438377	48,00
		0,5	18	13	5	B-40559	0088381438384	48,00
		0,5	24	13	5	B-40565	0088381438391	47,00

Sierras para DSD180 - SD100D



Aplicación	Unds.	Código	EAN	P.V.P. (€)
Tabiquería seca*	2	B-49703	0088381460934	21,00
Madera	2	B-49719	0088381460941	27,00

* Perfecta para realizar cajeados en tabiquería seca.





Soporte de lijas LB1200F

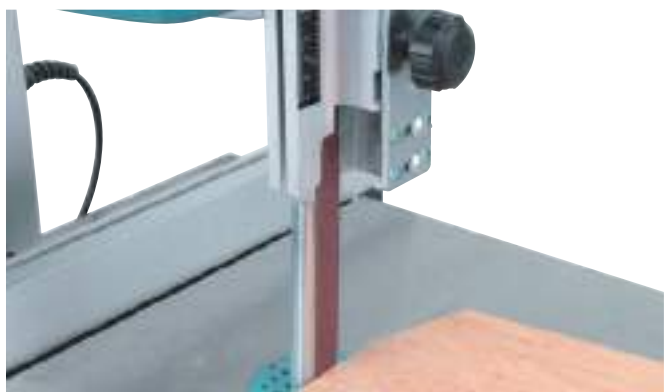

Unds.	Código	EAN	P.V.P. (€)
1	JM21000330	0088381374170	14,95

Guía paralela para LB1200F



Unds.	Código	EAN	P.V.P. (€)
1	JM21080230	3240890352613	19,55

Guía angular



Unds.	Código	EAN	P.V.P. (€)
1	JM21080260	3240890352620	10,80

Extensión de mesa para LB1200F



Unds.	Código	EAN	P.V.P. (€)
1	JM21000300	0088381374156	83,00

Set para corte circular para LB1200F



Unds.	Código	EAN	P.V.P. (€)
1	JM21000320	0088381374163	23,00

Toma de aspiración



Unds.	Código	EAN	P.V.P. (€)
1	JM27000090	3240890357519	0,75

Soporte y protector para 2107FK



Protector



Soporte



Descripción	Unds.	Código	EAN	P.V.P. (€)
Protector	1	196325-9	0088381431576	108,00
Soporte	1	194026-3	0088381194662	640,00



Tope de profundidad

Pasta lubricante



Fijo

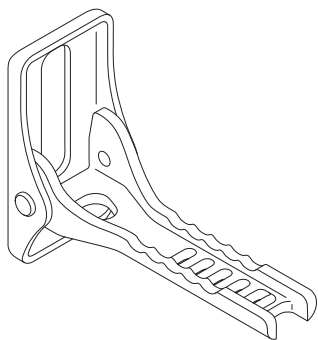

Móvil

Modelo	Tipo	Unds.	Código	EAN	P.V.P. (€)
JR3050T JR3060T	Fijo (equipo básico)	1	165396-7	-	5,50
JR3070CT	Fijo (equipo básico)	1	165406-0	-	4,80
JR3070CT	Móvil (opcional)	1	163453-5	-	7,10



Unds.	Código	EAN	P.V.P. (€)
1	191897-9	0088381117319	11,35

Sierras de calar



Sierras de calar 18V con motor BL sin escobillas.



DJV182 y DJV181

**BL
MOTOR**



**Velocidad variable.
Colector de polvo con posi-
bilidad de conectar a nues-
tra gama de aspiradores.**



Sistema pendular en 4 posiciones, para cortes rápidos.















Explicación de símbolos y materiales

Materiales

	Madera		Corte imperfecto
	Madera con clavos		Corte perfecto
	Aglomerado		Aluminio
	Parquet laminado		Acero Inoxidable
	Plástico reforzado con fibra de vidrio		Placas Sandwich
	PVC (plástico)		Cristal, cerámica
	Metal		Goma, cuero, material aislante

Tipo de hoja

		Calidad del material de la sierra		Larga vida
				Cuchilla extremadamente afilada
	Corte recto		CORTE RÁPIDO	Corte rápido
	Corte curvo		DOBLE	Cuchilla doble
	Dentado con los dientes inclinados		COMBINO	Combinado



Corte Super Express



Tipo	Descripción	Dientes por pulgada	Longitud útil (mm)	Calidades material	Madera	Plástico	Aluminio	Metal inox	Metal no ferroso	Metal	Tipo Clase B	Unds. paquete	Código	EAN	P.V.P (€)
B-50	Hoja superexpress con un gran rendimiento en las caladoras a batería: madera y plásticos.	8 - 11	73	HCS	5,5	5,5	-	-	-	-	T234X	5	B-06460	0088381276702	8,00



B-51	Hoja superexpress con un gran rendimiento en las caladoras a batería: Metal	10 - 18	73	HHS	-	-	-	1,3	-	1,8	T123X	5	B-06476	0088381276719	8,00
------	---	---------	----	-----	---	---	---	-----	---	-----	-------	---	---------	---------------	------



B-52	Hoja superexpress con un gran rendimiento en las caladoras a batería: Universal	6 - 10	73	HHS	5,5	5,5	-	-	-	-	T345XF	5	B-06482	0088381276726	9,55
------	---	--------	----	-----	-----	-----	---	---	---	---	--------	---	---------	---------------	------



-	Conjunto Super Express	-	77	HHS	-	-	-	-	-	-	-	3	B-06292	0088381249713	6,35
---	------------------------	---	----	-----	---	---	---	---	---	---	---	---	---------	---------------	------

Corte básico - Madera



Tipo	Descripción	Dientes por pulgada	Longitud útil (mm)	Calidades material	Madera	Plástico	Aluminio	Metal inox	Metal no ferroso	Metal	Tipo Clase B	Unds. paquete	Código	EAN	P.V.P (€)
B13	Para cortes en madera y plásticos	8	75	HCS	4-65	4-65	-	-	-	-	T111C	5	A-85656	0088381149563	4,20



B15	Para madera prensada y tableros de fibra de hasta 3mm, plásticos hasta 35mm.	12	50	HCS	3-35	3-35	-	-	-	-	T119B	5	A-85678	0088381149655	3,90
-----	--	----	----	-----	------	------	---	---	---	---	-------	---	---------	---------------	------





B14	Para madera prensada y tableros de fibra de hasta 8mm, plásticos hasta 35mm (corte rápido).	18	51	HCS	2-35	2-35	-	-	-	-	-	5	A-85662	0088381149648	3,90
-----	---	----	----	-----	------	------	---	---	---	---	---	---	---------	---------------	------



B18	Ideal para cortes en curva en madera y plástico	14	44	HCS	2-35	2-35	-	-	-	-	T119BO	5	A-85709	0088381149662	4,45
-----	---	----	----	-----	------	------	---	---	---	---	--------	---	---------	---------------	------





Corte rápido - Madera



Tipo	Descripción	Dientes por pulgada	Longitud útil (mm)	Calidades material	Madera	Plástico	Aluminio	Metal inox	Metal no ferroso	Metal	Tipo Clase B	Unds. paquete	Código	EAN	P.V.P (€)
B-16	 Makita JAPAN	6	75	HCS	5-65	5-65	-	-	-	-	T144D	5	A-85684	0088381149686	5,65
L02	 Makita Germany	6	100	HCS	5-90	5-90	-	-	-	-	-	5	A-86309	0088381150279	8,05
L10	 Makita Germany	6	151	HCS	5-135	5-135	-	-	-	-	T344D	5	A-86315	0088381150286	11,00
B17	 Makita JAPAN	6	70	HCS	5-60	-	-	-	-	-	T244D	5	A-85690	0088381149693	5,80
-	 Makita Holz-Blatt 75 mm	6	75	HCS/CV	8-65	-	-	-	-	-	-	5	P-31572	0088381959735	7,75
-	 Makita Holz-Blatt Bi-metal 75 mm	6	75	BIM	8-65	-	-	-	-	-	T144DF	5	P-31588	0088381959742	10,15

Corte maderas laminadas



Tipo	Descripción	Dientes por pulgada	Longitud útil (mm)	Calidades material	Madera	Plástico	Aluminio	Metal inox	Metal no ferroso	Metal	Tipo Clase B	Unds. paquete	Código	EAN	P.V.P (€)
B19	 Makita JAPAN	12	63	HCS	3-50	3-50	-	-	-	-	T101BR	5	A-85715	0088381149709	5,50
B28	 Makita JAPAN	16	63	HSS	2-50	2-50	-	-	-	-	T101BIF	5	A-80391	0088381136938	10,50
B-53	 Makita Laminat	15	82	-	-	-	-	-	-	-	T101BIF	5	B-10970	0088381351461	12,70
B-54	 Makita Laminat	15	82	-	-	-	-	-	-	-	T101AOF	5	B-10986	0088381351478	14,85
B16	 Makita Laminat-Blatt Bi-metal 60 mm	12	60	BIM	5-20	-	-	-	-	-	T101AIF	5	P-31566	0088381959728	10,45

Corte limpio madera

Tipo	Descripción	Dientes por pulgada	Longitud útil (mm)	Calidades material	Madera	Plástico	Aluminio	Metal inox	Metal no ferroso	Metal	Tipo Clase B	Unds. paquete	Código	EAN	P.V.P (€)
N59	Corte rápido y limpio en toda clase de madera y plástico..	8	75	HCS	4-65	4-65	-	-	-	-	T101B	5	A-86583	0088381150934	7,30
B10	Corte rápido y limpio en madera y plásticos, especialmente indicado para madera contrachapada.	9	75	HCS	3-65	3-65	-	-	-	-	-	5	A-85628	0088381149716	6,20
B11	Para terminación de trabajos rápido. Corte limpio.	9	75	HCS	3-60	3-60	-	-	-	-	T101B	5	A-85634	0088381149549	6,50
B12	Para terminación de trabajos rápido. Corte limpio.	6	75	HCS	5-65	5-65	-	-	-	-	T101D	5	A-85640	0088381149556	5,20
L01	Hoja gruesa y larga para cortes limpios y rectos.	6	100	HCS	5-90	5-90	-	-	-	-	T301CD	5	A-86290	0088381150262	11,55
B29	Ideal para corte curvo para madera y plásticos. (acabado).	16	42	HCS	2-35	2-35	-	-	-	-	T101AO	5	A-80400	0088381136945	9,95
BR13	Corte sin astillas en madera, no requieren lijado. La hoja corta hacia arriba y abajo para un buen acabado de la superficie.	9	64	HCS	5-65	-	-	-	-	-	-	5	A-85793	0088381149679	4,45
-	Corte limpio en toda clase de madera y plástico con una prolongada vida útil.	10	75	BIM	5-65	5-65	-	-	-	-	T101BF	5	P-31594	00883811959759	10,70

Corte - Maderas duras

Tipo	Descripción	Dientes por pulgada	Longitud útil (mm)	Calidades material	Madera	Plástico	Aluminio	Metal inox	Metal no ferroso	Metal	Tipo Clase B	Unds. paquete	Código	EAN	P.V.P (€)
B25	Para madera dura, para chapa.	9	75	HSS	3-60	3-60	3-6	-	-	3-6	T127D	5	A-85765	0088381149600	5,25
B26	Para cortes curvos en madera dura, metal, metal no ferroso y plásticos duros.	9	70	HSS	3-60	3-60	3-10	-	3-10	3-10	T227D	5	A-85771	0088381149617	5,85

Corte - Madera con clavo



Tipo	Descripción	Dientes por pulgada	Longitud útil (mm)	Calidades material	Madera	Plástico	Aluminio	Metal inox	Metal no ferroso	Metal	Tipo Clase B	Unds. paquete	Código	EAN	P.V.P (€)
M-Force	Diente en M para el corte rápido de madera, metales y madera con clavo. Corta en las dos direcciones para aumentar la velocidad de corte.	5	130	BIM	105	-	-	-	-	-	-	2	P-45749	0088381976183	8,05



-	Ideal para madera con clavo.	9-10	105	BIM	5-95	-	-	-	-	2,5-10	-	5	P-49638	0088381980081	11,75
---	------------------------------	------	-----	-----	------	---	---	---	---	--------	---	---	---------	---------------	-------



-	Ideal para madera con clavo.	9-10	75	BIM	5-65	-	-	-	-	2,5-10	T111HF	5	P-49622	0088381980074	10,45
---	------------------------------	------	----	-----	------	---	---	---	---	--------	--------	---	---------	---------------	-------

Corte básico - Metal



Tipo	Descripción	Dientes por pulgada	Longitud útil (mm)	Calidades material	Madera	Plástico	Aluminio	Metal inox	Metal no ferroso	Metal	Tipo Clase B	Unds. paquete	Código	EAN	P.V.P (€)
N51	Para chapa fina de acero y acero inoxidable.	24	75	HSS	-	1,5-6	1,5-6	1-3	-	1-3	-	5	A-86561	0088381150910	6,90



B22	Para acero medio, inoxidable y plásticos duros, especialmente indicado para chapa fina.	24	50	HSS	-	1-6	1-3	1-3	-	1-3	T118A	5	A-85737	0088381149570	5,25
-----	---	----	----	-----	---	-----	-----	-----	---	-----	-------	---	---------	---------------	------



B24	Para acero medio fino, inoxidable y chapas de acero muy finas.	32	50	HSS	-	1-3	1-2	0,5-2	-	0,5-2	T118G	5	A-85759	0088381149594	5,00
-----	--	----	----	-----	---	-----	-----	-------	---	-------	-------	---	---------	---------------	------



B23	Acero medio, chapa de espesor medio, madera, chapa de madera decorativa y acero no ferroso.	14	50	HSS	3-35	3-35	2-6	-	2-6	2-6	T118B	5	A-85743	0088381149587	5,00
-----	---	----	----	-----	------	------	-----	---	-----	-----	-------	---	---------	---------------	------



B27	Para cortes curvos en acero medio y no ferroso.	24	50	HSS	-	1-6	1-3	1-3	1-3	1-3	T218A	5	A-85787	0088381149631	6,35
-----	---	----	----	-----	---	-----	-----	-----	-----	-----	-------	---	---------	---------------	------

Corte - Metal



Tipo	Descripción	Dientes por pulgada	Longitud útil (mm)	Calidades material	Madera	Plástico	Aluminio	Metal inox	Metal no ferroso	Metal	Tipo Clase B	Unds. paquete	Código	EAN	P.V.P (€)
-	Para revestimiento de 80mm y materiales de sandwich. (hoja flexible)	25	105	BIM	-	-	-	-	-	1-3	T318AF	5	P-47204	0088381977630	9,90



-	Para tubería fina de materiales no ferrosos y revestimientos.	13	105	BIM	-	-	-	-	2,5-6	2,5-6	T318BF	5	P-47210	0088381977647	9,35
---	---	----	-----	-----	---	---	---	---	-------	-------	--------	---	---------	---------------	------



-	Hoja flexible para chapa fina de acero medio e inoxidable con una prolongada vida útil.	21	55	BIM	-	-	-	1,2-2	-	1,2-2	T118AF	5	P-47226	0088381977654	7,75
---	---	----	----	-----	---	---	---	-------	---	-------	--------	---	---------	---------------	------

Corte - Especial Inox



Tipo	Descripción	Dientes por pulgada	Longitud útil (mm)	Calidades material	Madera	Plástico	Aluminio	Metal inox	Metal no ferroso	Metal	Tipo Clase B	Unds. paquete	Código	EAN	P.V.P (€)
-	Para acero medio e inoxidable	24	50	CV-HM	-	-	1,5-3	1,5-3	-	1,5-3	T118A-HM	1	P-05929	0088381944441	13,40



-	Hoja flexible para aceros medio e inoxidable, metal no ferroso con una prolongada vida útil	14	55	BIM	-	-	2-3	2-3	-	2-3	T118BF	5	P-47232	0088381977661	7,75
---	---	----	----	-----	---	---	-----	-----	---	-----	--------	---	---------	---------------	------

Corte - Especial plásticos

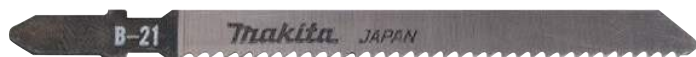

Tipo	Descripción	Dientes por pulgada	Longitud útil (mm)	Calidades material	Madera	Plástico	Aluminio	Metal inox	Metal no ferroso	Metal	Tipo Clase B	Unds. paquete	Código	EAN	P.V.P (€)
B21	Para trabajos de acabado en plásticos y aluminio.	12	75	HSS	-	3-60	1-10	-	-	-	T101A	5	A-85721	0088381149624	8,45

Corte - Especial materiales blandos



Tipo	Descripción	Dientes por pulgada	Longitud útil (mm)	Calidades material	Madera	Plástico	Aluminio	Metal inox	Metal no ferroso	Metal	Tipo Clase B	Unds. paquete	Código	EAN	P.V.P (€)
-	Ideal para cartar papel, corcho, goma y cuero.	-	75	HCS	-	-	-	-	-	-	T113A	5	A-80416	0088381136952	16,50

Corte - Especial cerámica y fibra de vidrio



Tipo	Descripción	Dientes por pulgada	Longitud útil (mm)	Calidades material	Madera	Plástico	Aluminio	Metal inox	Metal no ferroso	Metal	Tipo Clase B	Unds. paquete	Código	EAN	P.V.P (€)
-	Para cerámica de 5 - 15mm corte basto.	-	54	CV-HM	-	-	-	-	-	-	T130RI-FF	3	P-38788	0088381966696	14,45

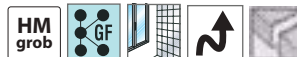

-	Para cerámica de grueso 5 - 20mm corte fino.	-	54	CV-HM	-	-	-	-	-	-	T150RI-FF	3	P-38794	0088381966702	14,45
---	--	---	----	-------	---	---	---	---	---	---	-----------	---	---------	---------------	-------



-	Para fibra de vidrio y plásticos reforzados. Dientes de carburo de tungsteno.	6	75	CV-HM	10-60	-	-	-	-	-	T141HM	3	B-06890	0088381289177	24,00
---	---	---	----	-------	-------	---	---	---	---	---	--------	---	---------	---------------	-------



-	Para fibra de vidrio y plásticos reforzados. Dientes de carburo de tungsteno.	6	105	CV-HM	10-95	-	-	-	-	-	T341HM	3	B-06909	0088381289184	33,00
---	---	---	-----	-------	-------	---	---	---	---	---	--------	---	---------	---------------	-------

Corte - Especial panel sandwich



Tipo	Descripción	Dientes por pulgada	Longitud útil (mm)	Calidades material	Madera	Plástico	Aluminio	Metal inox	Metal no ferroso	Metal	Tipo Clase B	Unds. paquete	Código	EAN	P.V.P (€)
-	Ideal para cartar papel, corcho, goma y cuero.	24	155	BIM	5-145	5-145	-	-	-	-	T718BF	5	P-49644	0088381980098	13,40

Conjuntos de hojas a granel

Para corte rápido y limpio en madera y plásticos. Especial madera contrachapada



Tipo	Descripción	Dientes por pulgada	Longitud útil (mm)	Calidades material	Madera	Plástico	Aluminio	Metal inox	Metal no ferroso	Metal	Tipo Clase B	Unds. paquete	Código	EAN	P.V.P (€)
B10	Conjunto de hojas a granel	9	75	HCS	3-65	3-65	-	-	-	-	T301CD	100	B-07674	0088381335294	99,00

Para terminación de trabajos rápido. Corte limpio



Tipo	Descripción	Dientes por pulgada	Longitud útil (mm)	Calidades material	Madera	Plástico	Aluminio	Metal inox	Metal no ferroso	Metal	Tipo Clase B	Unds. paquete	Código	EAN	P.V.P (€)
B11	Conjunto de hojas a granel	9	75	HCS	3-60	3-60	-	-	-	-	T101B	100	B-07680	0088381335300	104,00

Para corte rápido en madera y plásticos. Corte rápido y basto



Tipo	Descripción	Dientes por pulgada	Longitud útil (mm)	Calidades material	Madera	Plástico	Aluminio	Metal inox	Metal no ferroso	Metal	Tipo Clase B	Unds. paquete	Código	EAN	P.V.P (€)
B16	Conjunto de hojas a granel	6	75	HCS	5-65	5-65	-	-	-	-	T144D	100	B-07711	0088381335331	88,00

Para acero medio, inoxidable y plásticos duros. Indicado para chapa fina



Tipo	Descripción	Dientes por pulgada	Longitud útil (mm)	Calidades material	Madera	Plástico	Aluminio	Metal inox	Metal no ferroso	Metal	Tipo Clase B	Unds. paquete	Código	EAN	P.V.P (€)
B22	Conjunto de hojas a granel	24	50	HSS	-	1-6	1-3	1-3	-	1-3	T118A	100	B-07733	0088381335355	84,00

Para cortes en madera y plásticos



Tipo	Descripción	Dientes por pulgada	Longitud útil (mm)	Calidades material	Madera	Plástico	Aluminio	Metal inox	Metal no ferroso	Metal	Tipo Clase B	Unds. paquete	Código	EAN	P.V.P (€)
B13	Conjunto de hojas a granel	8	80	HCS	4-65	4-65	-	-	-	-	T111C	100	B-07705	0088381335324	68,00



Tipos de hojas - Inserción Makita

Corte - Madera



Tipo	Descripción	Dientes por pulgada	Longitud útil (mm)	Calidades material	Madera	Plástico	Aluminio	Metal inox	Metal no ferroso	Metal	Tipo Clase B	Unds. paquete	Código	EAN	P.V.P (€)
3	Para toda clase de maderas y plásticos.	9	60	HCS	3-50	3-50	-	-	-	-	-	5	A-85868	0088381149457	4,45



16	Corte curvo en maderas blandas y material aislante.	9	60	HCS	3-50	3-50	-	-	-	-	-	5	792207-9	0088381100342	4,90
----	---	---	----	-----	------	------	---	---	---	---	---	---	----------	---------------	------

Corte rápido - Madera



Tipo	Descripción	Dientes por pulgada	Longitud útil (mm)	Calidades material	Madera	Plástico	Aluminio	Metal inox	Metal no ferroso	Metal	Tipo Clase B	Unds. paquete	Código	EAN	P.V.P (€)
8	Corte rápido en toda la clase de maderas y plásticos.	8	60	HCS	4-50	4-50	-	-	-	-	-	5	A-85911	0088381149723	5,55

Corte acabado - Madera

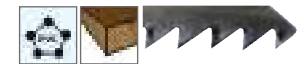

Tipo	Descripción	Dientes por pulgada	Longitud útil (mm)	Calidades material	Madera	Plástico	Aluminio	Metal inox	Metal no ferroso	Metal	Tipo Clase B	Unds. paquete	Código	EAN	P.V.P (€)
9	Corte limpio y rápido en toda la clase de madera y plásticos.	8	60	HCS	4-50	4-50	-	-	-	-	-	5	A-85927	0088381149730	7,05



10	Corte limpio y rápido en toda la clase de madera y plásticos. Especial para Plywood.	9	60	HCS	4-50	4-50	-	-	-	-	-	5	A-85818	0088381149488	7,30
----	--	---	----	-----	------	------	---	---	---	---	---	---	---------	---------------	------



BR3	Hoja especial para cortes de la superficie sin astillas.	9	60	HCS	4-50	-	-	-	-	-	-	5	A-85933	0088381149747	4,45
-----	--	---	----	-----	------	---	---	---	---	---	---	---	---------	---------------	------

Corte - Maderas duras y contrachapados decorativos



Tipo	Descripción	Dientes por pulgada	Longitud útil (mm)	Calidades material	Madera	Plástico	Aluminio	Metal inox	Metal no ferroso	Metal	Tipo Clase B	Unds. paquete	Código	EAN	P.V.P (€)
2	Para chapas finas de acero e inoxidable.	14	60	HSS	3-50	3-50	2-6	-	2-6	-	-	5	A-85852	0088381149440	5,55



4	Para madera dura, metal no ferroso y plásticos duros.	9	60	HSS	3-50	3-50	3-6	-	3-6	-	-	5	A-85874	0088381149464	5,55
---	---	---	----	-----	------	------	-----	---	-----	---	---	---	---------	---------------	------

Corte - Madera



Tipo	Descripción	Dientes por pulgada	Longitud útil (mm)	Calidades material	Madera	Plástico	Aluminio	Metal inox	Metal no ferroso	Metal	Tipo Clase B	Unds. paquete	Código	EAN	P.V.P (€)
41	Para corte de madera y plástico sin astillas. Dientes invertidos.	12	60	HSS	3-50	3-50	-	-	-	-	-	5	A-85880	0088381149525	5,80



42	Hoja especial sin inclinación para un buen acabado de ambos lados, laminados y tableros múltiples.	16	60	HSS	2-50	-	-	-	-	-	-	5	A-85896	0088381149532	9,00
----	--	----	----	-----	------	---	---	---	---	---	---	---	---------	---------------	------

Corte - Metal



Tipo	Descripción	Dientes por pulgada	Longitud útil (mm)	Calidades material	Madera	Plástico	Aluminio	Metal inox	Metal no ferroso	Metal	Tipo Clase B	Unds. paquete	Código	EAN	P.V.P (€)
1	Para chapas finas de acero e inoxidable.	24	60	HSS	-	-	1-3	0,5-3	1-3	-	-	5	A-85802	0088381149433	5,55



5	Para chapas finas de acero e inoxidable.	24	42	HSS	-	-	1-3	1-3	1-3	-	-	5	A-85905	0088381149471	6,05
---	--	----	----	-----	---	---	-----	-----	-----	---	---	---	---------	---------------	------

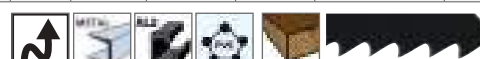

17	Corte curvo en madera dura, metal no ferroso y plásticos duros.	14	63	HSS	2-50	2-50	2-6	-	2-6	-	-	5	792216-8	0088381100359	8,25
----	---	----	----	-----	------	------	-----	---	-----	---	---	---	----------	---------------	------



Guías de carril y accesorios



Pieza para unir dos carriles



Guía carril



Funda para carril guía

Descripción	Longitud (m)	Unds.	Código	EAN	P.V.P (€)
Pieza para unir dos carriles	-	1	198885-7	0088381497046	25,00
Guía carril	1	1	199140-0	0088381528672	45,00
	1,4	1	194368-5	0088381313353	71,00
	1,9	1	194925-9	0088381354790	109,00
	3	1	194367-7	0088381335201	185,00
Funda para carril guía	1	1	E-05670	0088381567183	46,00
	1,4	1	E-05664	0088381567176	53,00
	1,9	1	E-10920	0088381581523	83,00
	3	1	E-10936	0088381581530	103,00

Adaptador para guía de carril



Modelos	Unds.	Código	EAN	P.V.P (€)
4350T / CT / FCT 4351CT / FCT 4329 DJV180 / 181 / 182 JV0600	1	193517-1	0088381170659	30,00

Llaves allen



Modelos	Unds.	Código	EAN	P.V.P (€)
4326 4327 4328 4329	1	783201-2	0088381101288	1,05
4350T/CT/FCT 4351T/CT/FCT DJV180 / 181 / 182	1	783202-0	0088381102667	1,05

Mordaza para carril guía



Modelos	Unds.	Código	EAN	P.V.P (€)
Guías de carril	2	194385-5	0088381314084	28,00

Guía lateral + circular (A + B)



Tipo	Modelo	Unds.	Código	EAN	P.V.P (€)
A + B	DJV180 DJV181 DJV182	1	193516-3	0088381170666	9,55
A + B	4326 4327 4328 4329 JV0600 JV100D JV103	1	192732-4	0088381148054	8,20

Accesorios

Placa antiastillamiento



415524-7

Protector de base



417852-6

Adaptador de aspiración



417853-4

Adaptador de aspiración



192349-3

Tipo	Modelo	Unds.	Código	EAN	P.V.P (€)
Placa antiastillamiento	DJV182 4350T/CT/FCT 4351CT/FCT	1	415524-7	0088381131681	0,75
	4322 4323 4324	1	416477-3	0088381148207	0,50
	4329 4350T/CT/FCT 4351T/CT/FCT, DJV180 / 181 / 182 JV0600	1	417852-6	0088381177498	2,60
Adaptador de aspiración	4326 4327 4328 4329 JV0600	1	192349-3	0088381126229	7,70
	4350T/CT/FCT 4351CT/FCT DJV180	1	417853-4	0088381170833	1,05

Fresado



Fresas - Índice

Fresas rectas págs. 253 - 254

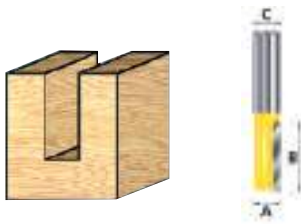

Fresas en V pág. 256

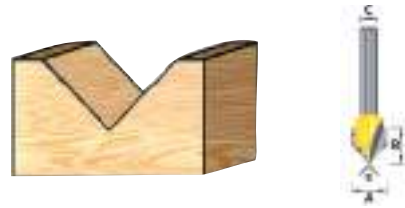

Fresas para paneles pág. 254



Fresas de media caña pág. 256



Fresas en U pág. 255

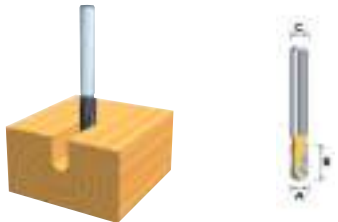

Fresas Machi-hembrado pág. 256



Fresas de recorte pág. 255



Fresas para aluminio pág. 257

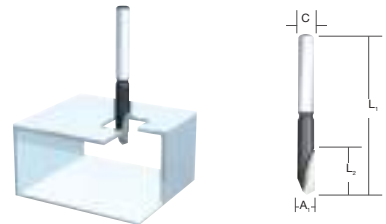

Fresas molduradoras pág. 255

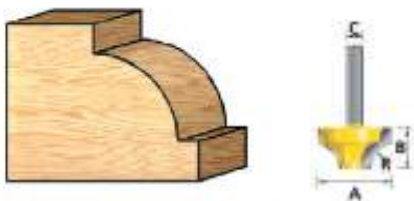

Fresas para 3706, DCO180 y DCO181 pág. 257



Fresas redondeadoras pág. 255



Discos y galletas para PJ7000 pág. 258



Fresas biseladoras pág. 256

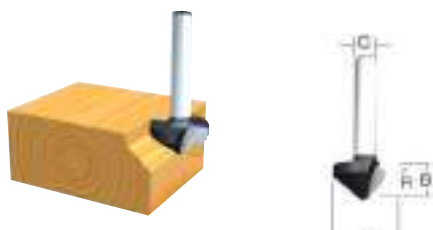

Accesorios para 7104L pág. 258



Fresas para madera

Estuches de fresas

- Estuches con diferentes tipos de fresas para diversas aplicaciones.

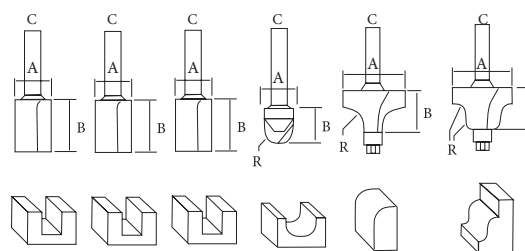
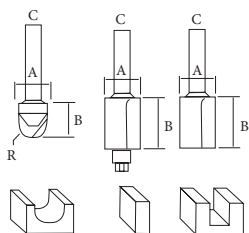

A (mm)	B (mm)	C (mm)	Tipo	Unds.	Código	EAN	P.V.P (€)
-	-	6	HM	3	D-30209	0088381352772	21,35
-	-	6	HM				
-	-	6	HM				

A (mm)	B (mm)	C (mm)	R (mm)	Unds.	Código	EAN	P.V.P (€)
6	16	8	-	6	D-53540	0088381449915	65,00
10	19	8	-				
12	19	8	-				
12,7	10	8	6,35				
31,8	16,7	8	9,5				
28,6	13	8	4				

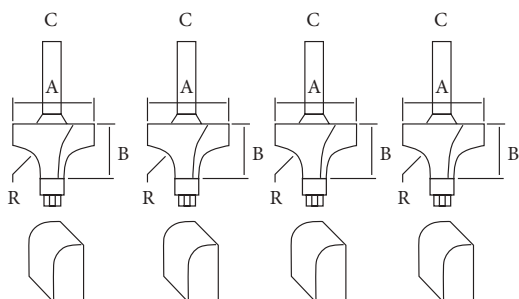

A (mm)	B (mm)	C (mm)	R (mm)	Unds.	Código	EAN	P.V.P (€)
19	9,5	8	3,2	4	D-53534	0088381449908	63,00
25,4	13,5	8	6,35				
31,8	16,7	8	9,5				
38,1	19	8	38,1				

Fresas rectas un filo

- Fresas indicadas para pequeñas ranuras.
- Herramienta de corte de HM.
- Ideal para madera y contrachapado.

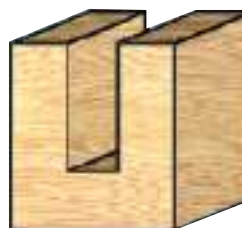

A (mm)	B (mm)	C (mm)	Tipo	Unds.	Código	EAN	P.V.P (€)
6	18	6	HM	1	D-09167	0088381184373	9,55
3	8	8	HM	1	D-10001	0088381165044	7,70
4	10	8	HM	1	D-10017	0088381165051	8,50
5	12,7	8	HM	1	D-10023	0088381165068	8,50
6	8	8	HM	1	D-10039	0088381165075	8,75

Fresas para madera

Fresas rectas dos filos

- Herramienta de corte de HM.
- Máxima precisión de corte.
- Ideal para madera, contrachapados, plásticos y materiales abrasivos.

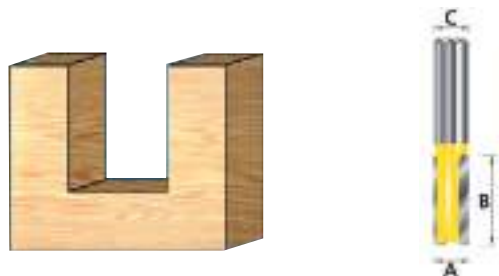

A (mm)	B (mm)	C (mm)	Tipo	Unds.	Código	EAN	P.V.P (€)
3	95	6	HM	1	D-09210	0088381181969	17,40
4	10	6	HM	1	D-09226	0088381181976	18,30
5	12	6	HM	1	D-09232	0088381181983	8,75
6	16	6	HM	1	D-09248	0088381182003	8,75
7	25	6	HM	1	D-09254	0088381182010	8,75
8	20	6	HM	1	D-09260	0088381182027	8,75
9	25	6	HM	1	D-09276	0088381182034	9,00
10	25	6	HM	1	D-09282	0088381182041	9,00
12	32	6	HM	1	D-09298	0088381182058	9,55
15	20	6	HM	1	D-09307	0088381182065	10,80
20	20	6	HM	1	D-09313	0088381182072	12,60
6	19	8	HM	1	D-10051	0088381165099	10,30
8	20	8	HM	1	D-10067	0088381165105	11,35
10	20	8	HM	1	D-10285	0088381165327	16,50
12	20	8	HM	1	D-10291	0088381165334	18,55
14	20	8	HM	1	D-10300	0088381165341	21,00
15	20	8	HM	1	D-10316	0088381165358	21,00
16	20	8	HM	1	D-10322	0088381165365	22,00
18	20	8	HM	1	D-10338	0088381165372	25,00
20	20	8	HM	1	D-10344	0088381165389	24,00
22	20	8	HM	1	D-10350	0088381165396	26,00
24	20	8	HM	1	D-10366	0088381165402	28,00
25	20	8	HM	1	D-10372	0088381165419	28,00
8	30	12	HM	1	D-10176	0088381165211	11,85
10	30	12	HM	1	D-10182	0088381165228	12,90
10	35	12	HM	1	D-10388	0088381165426	21,00
12	32	12	HM	1	D-10198	0088381165235	12,90
15	35	12	HM	1	D-10419	0088381165457	25,00
16	35	12	HM	1	D-10425	0088381165464	30,00
18	35	12	HM	1	D-10431	0088381165471	28,00
20	35	12	HM	1	D-10447	0088381165488	31,00
22	35	12	HM	1	D-10453	0088381165495	32,00
24	35	12	HM	1	D-10469	0088381165501	32,00
25	35	12	HM	1	D-10475	0088381165518	32,00

Fresas para paneles

- Herramienta de corte HM.
- Para el fresado de paneles. Con punta de broca para penetrar rápidamente en el material.



A (mm)	B (mm)	C (mm)	Tipo	Unds.	Código	EAN	P.V.P (€)
6	19	6	HM	1	D-09335	0088381182096	12,90
12	25,4	12	HM	1	D-10584	0088381165624	14,95

Fresas dobles para paneles

- Herramienta de corte HM.
- Para el fresado de paneles del contrachapado superior e inferior a la vez.
- Punta de broca para penetrar rápidamente.

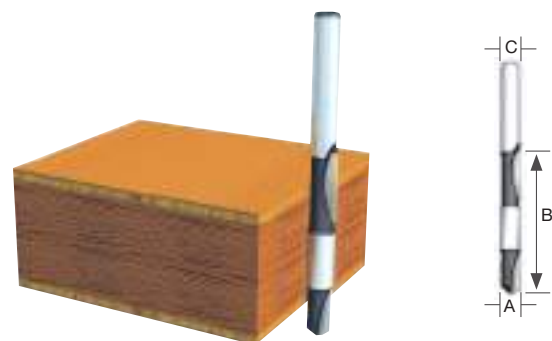

A (mm)	B (mm)	C (mm)	Tipo	Unds.	Código	EAN	P.V.P (€)
6	40	6	HM	1	D-09341	0088381182102	24,00
8	55	8	HM	1	793061-4	0088381108225	32,00

Fresas para madera

Fresas en "U"

- Herramienta de corte HM.
- Para realizar cualquier motivo decorativo.
- Indicado en madera maciza y materiales abrasivos.



A (mm)	B (mm)	C (mm)	Tipo	Unds.	Código	EAN	P.V.P (€)
6	13	6	HM	1	D-09329	0088381182089	12,90

Fresas de recorte con rodamiento

- Herramienta de corte HM.
- Con rodamiento que se utiliza como guía.
- Perfecta para copiar piezas con gran desbaste.
- Para madera maciza y materiales abrasivos.



A (mm)	B (mm)	C (mm)	Tipo	Unds.	Código	EAN	P.V.P (€)
9,5	25,4	6	HM	1	D-09472	0088381182232	15,20
12,7	38,1	12	HM	1	D-10497	0088381165532	21,00

Redondeadora con rodamiento

- Herramienta de corte de HM.
- Fresa con rodamiento inferior, ideal para cantos.
- Para madera maciza y materiales abrasivos.



A (mm)	B (mm)	R (mm)	C (mm)	Tipo	Unds.	Código	EAN	P.V.P (€)
15	7	3	6	HM	1	D-09422	0088381182188	17,50
21	10	6	6	HM	1	D-09444	0088381182201	22,00

Molduradora sin rodamiento

- Herramienta de corte de HM.
- Fresas para cantos y ranuras.
- Ideal para maderas macizas y materiales abrasivos.

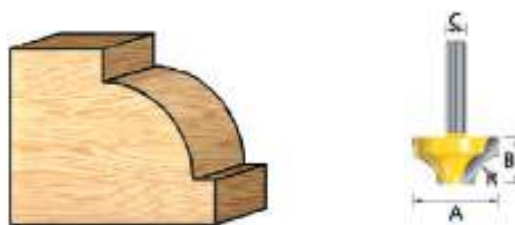

A (mm)	B (mm)	R (mm)	C (mm)	Tipo	Unds.	Código	EAN	P.V.P (€)
16	9	4	6	HM	1	D-09357	0088381182119	19,55
25	13	8	6	HM	1	D-09363	0088381182126	24,00

Molduradora

- Herramienta de corte HM.
- Fresas para perfilar y moldurar con ángulo convexo.
- Para madera maciza.



A (mm)	B (mm)	R (mm)	C (mm)	Tipo	Unds.	Código	EAN	P.V.P (€)
20	10	2,5	6	HM	1	D-09575	0088381182331	25,00
22	10	3	6	HM	1	D-09553	0088381182317	26,00
26	12	3	6	HM	1	D-09581	0088381182348	24,00
31,75	38,1	9,53	6	HM	1	D-11829	0088381166867	65,00

Molduradora con rodamiento

- Herramienta de corte HM.
- Similar a la fresa redondeadora pero con un rodamiento más pequeño, dando una forma más decorativa.
- Para madera maciza y materiales abrasivos.

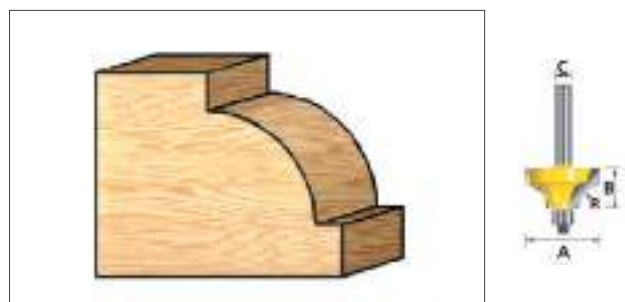

A (mm)	B (mm)	R (mm)	C (mm)	Tipo	Unds.	Código	EAN	P.V.P (€)
20	10	4	6	HM	1	D-09525	0088381182287	18,55
26	12	7	6	HM	1	D-09547	0088381182300	22,00

Fresas para madera

Biseladora con rodamiento

- Herramienta de corte HM.
- Fresas perfectas para biselar, fácil y rápidamente gracias al rodamiento.
- Para madera maciza.

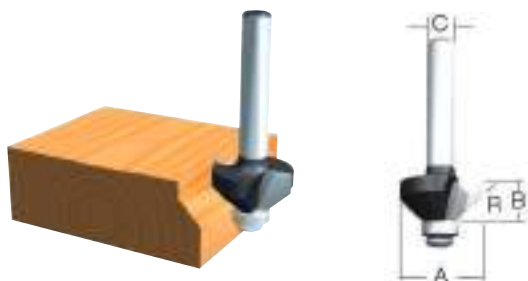

A (mm)	B (mm)	C (mm)	Tipo	Unds.	Código	EAN	P.V.P (€)
20	11	6	HM	1	D-09494	0088381182256	21,00
26	12	6	HM	1	D-09488	0088381182249	21,00

Machi-hembrado (macho)

- Herramienta de corte HM.
- Para realizar el ensamblaje de molduras (macho).
- Para madera maciza.

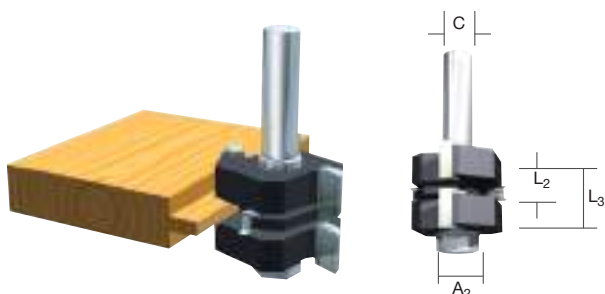

A (mm)	A1 (mm)	L2 / L3 (mm)	C (mm)	Tipo	Unds.	Código	EAN	P.V.P (€)
38	27	4 / 20	12	HM	1	D-12027	0088381167062	41,00



Media caña

- Herramienta de corte HM.
- Para fresados con cantos de muebles, cajones... con perfil convexo.
- Para madera maciza.

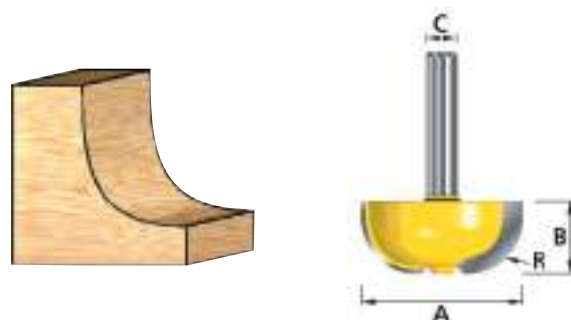

A (mm)	B (mm)	R (mm)	C (mm)	Tipo	Unds.	Código	EAN	P.V.P (€)
20	8	4	6	HM	1	D-09400	-	25,00
25	13	8	6	HM	1	D-09416	0088381182171	24,00

Fresas en "V"

- Herramienta de corte HM.
- Perfecta para ranuras, biselados o fresados de precisión.
- Válida para madera maciza, alucobond y materiales abrasivos.



A (mm)	B (mm)	R (°)	C (mm)	Tipo	Unds.	Código	EAN	P.V.P (€)
19	20	60°	6	HM	1	D-09391	0088381182157	23,00
20	15	30°	6	HM	1	D-09379	0088381182133	23,00
20	15	45°	6	HM	1	D-09385	0088381182140	22,00
12,7	12,7	90°	8	HM	1	D-10687	0088381165723	15,95
15,9	12,7	90°	8	HM	1	D-10693	0088381165730	18,55
12,7	12,7	90°	12	HM	1	D-10702	0088381165747	15,95
15,9	12,7	90°	12	HM	1	D-10718	0088381165754	19,05
32	22	90°	12	HM	1	D-10746	0088381165785	31,00

Fresas para taladrar aluminio

- Herramienta de corte HM.
- Para perforar aluminio.
- También válida para cajeados en aluminio.

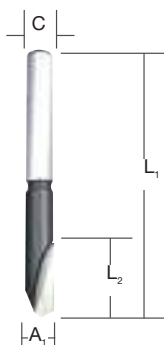

A1/ A2 (mm)	L1 (mm)	L2 (mm)	C (mm)	Tipo	Unds.	Código	EAN	P.V.P (€)
6	65	30	6	HM	1	D-16988	0088381194761	10,80

Fresas para 3706, DCO180 y DCO181

Fresas para tabiquería seca



Inserción (mm)	Modelo	Unds.	Código	EAN	P.V.P (€)
3,18 (1/8")	3706 DCO180 DCO181	1	733240-2	-	3,60
6,35 (1/4")		1	733232-1	0088381160544	10,80
3,18 (1/8") (multiuso)		1	193483-2	0088381163927	5,15



Accesorios para PJ7000 y 3901

Discos HM



Ø (mm)	Modelo	Unds.	Código	EAN	P.V.P (€)
100	PJ7000 3901	1	B-20644	0088381377133	24,00

Galletas

- Mas fácil y sencillo para la unión de tableros, más fácil de usar, permiten un juego (tolerancia) entre los tableros a ensamblar, más seguras y resistentes gracias a las galletas de alta resistencia.

Paquetes de 1.000 piezas. Alta calidad. Gran dureza.



Modelo	Medida (mm)	Grano	Unds.	Código	EAN	P.V.P (€)
50x20x4	3901 n°10	1000 piezas	1	P-08844	0088381921206	46,00
55x25x4	3901 n°20	1000 piezas	1	P-08850	0088381921213	46,00

Accesorios para 7104

Cadenas



Tipo	Medida (mm)	Modelo	Unds.	Código	EAN	P.V.P (€)
-	15	7104L	1	A-16564	0088381131612	366,00
-	16,5		1	A-16570	0088381131629	364,00
-	18,0		1	A-16586	0088381131636	384,00
-	21		1	A-16592	0088381131643	430,00
-	24,0		1	A-16601	0088381131650	493,00
Usar con piñón cod. 221502-5 y barra cod.122235-4.	30		1	A-16617	0088381131667	757,00

Aceite de cadena



Unds.	Código	EAN	P.V.P (€)
1	181434-7	0088381194747	1,25

Barra guía



Cadena	Descripción Tipo / Uso	Unds.	Código	EAN	P.V.P (€)
30mm	Usar cuando se coloque cadena de 30mm.	1	122235-4	0088381122764	319,00

Piñón



Cadena	Descripción Tipo / Uso	Unds.	Código	EAN	P.V.P (€)
30 mm	Usar cuando se coloque cadena de 30mm.	1	221502-5	-	17,00



Guía de ángulo



Modelo	Unds.	Código	EAN	P.V.P (€)
3901	1	122473-8	0088381127530	38,00
PJ7000 DPJ180 BPJ180	1	123149-0	0088381443173	19,90

Llave de pivotes 20



Modelos	Unds.	Código	EAN	P.V.P (€)
3901 PJ7000 DPJ180 BPJ180	1	782401-1	0088381101240	0,90

Casquillos cónicos



Modelo	Ø (mm)	Descripción	Unds.	Código	EAN	P.V.P (€)
3707FC	6	-	1	763607-0	0088381114806	2,60
	6,35 20,00	-	1	763608-8	0088381102292	3,10
3709 3710 4403	6	-	1	763662-2	0088381431606	3,80
	6,35 (1/4")	-	1	763663-0	0088381207294	4,10
RP1800 RP2300FC	1/2"	-	1	763622-4	0088381102315	15,45
	12	-	1	763628-2	0088381114813	15,45
	13	-	1	763632-1	0088381118538	24,00
3601B	12	-	1	763601-2	0088381123945	38,00
DRT50 RP0900 RT0700C RT0702C	6	-	1	763636-3	0088381142830	10,80
	6,35 (1/4")	-	1	763637-1	0088381102353	9,00
	8	-	1	763618-5	0088381114820	2,60
RP0910 RP110C	6	Con tuerca	1	193180-0	0088381156714	24,00
	8	Con tuerca	1	193178-7	0088381156721	21,00

Placa de ajuste



Modelos	Unds.	Código	EAN	P.V.P (€)
3901 PJ7000 DPJ180	1	415579-2	0088381155038	7,50

Bolsa guarda polvo



Modelos	Unds.	Código	EAN	P.V.P (€)
3901	1	122474-6	0088381127547	7,10
PJ7000 DPJ180 BPJ180	1	123150-5	0088381403092	6,55

Llaves



Reducción (mm)	Modelo	Unds.	Código	EAN	P.V.P (€)
8	RP0910 RP110C RP0900	1	781213-9	0088381102520	2,05
	DRT50 RT0700C RT0702C RP0900	1	781006-4	0088381102407	1,80
17	3709 3710 3706 3707FC RP0910 RP110C 4403	1	781008-0	0088381102414	1,80
	DRT50 RP0900 RT0700C RT0702C	1	781011-1	0088381102438	2,05
23	3601B	1	781012-9	0088381102445	2,15
24	RP1800 RP2300FC	1	781030-7	0088381151559	2,60

Casquillo reductor



Reducción (mm)	Modelo	Unds.	Código	EAN	P.V.P (€)
12 - 6 "	3601B RP1800 RP2300FC	1	763801-4	008838114646	3,10
12 - 8 "		1	763804-8	008838114653	3,10
12 - 10 "		1	763807-2	0088381124003	3,60
12 - 1/4 "		1	763803-0	0088381102360	3,10

Tuerca



Modelos	Unds.	Código	EAN	P.V.P (€)
3707FC 3709 3710 4403	1	763606-2	0088381123952	3,85
RP0900 RT0700C RT0702C	1	763615-1	0088381123969	3,10
RP0910 RP110C	1	763652-5	0088381170352	4,10
3612 3612C	1	763629-0	0088381123983	6,20
RP1800 RP2300FC	1	763674-5	-	6,70

Accesorios para 3706, DCO180 y DCO181



Guía circular



Modelos	Unds.	Código	EAN	P.V.P (€)
3706 DCO180 DCO181	1	193448-4	0088381163958	24,00

Colector de polvo



Modelos	Unds.	Código	EAN	P.V.P (€)
3706 DCO180 DCO181	1	193449-2	0088381160490	6,70

Casquillos cónicos



Medida (mm)	Modelo	Unds.	Código	EAN	P.V.P (€)
3,18	3706	1	324149-5	0088381161060	11,00
6,35 (1/4")		1	763608-8	0088381102292	3,10
3,18	DCO180 DCO181	1	763677-9	0088381468824	12,35
6,35 (1/4")		1	763676-1	0088381469012	14,95

Tuerca



Modelos	Unds.	Código	EAN	P.V.P (€)
3706	1	763606-2	0088381123952	3,85
DCO180 DCO181	1	763258-9	-	5,40

Guías de plantilla

1. Para modelos 3709, 3710, 3707FC, DRT50, RT0700C, RT0702C.

1



A (mm)	B (mm)	C (mm)	Modelos	Unds.	Código	EAN	P.V.P (€)
8,0	10,0	9,5	3709 3710 3707FC DRT50 RT0700C RT0702C	1	343577-5	008838115681	0,75

2. Para modelos DRT50, RP0900, RP1800X, RP2300FCX, RT0700* Y RT0702C.

2



A (mm)	B (mm)	C (mm)	Modelos	Unds.	Código	EAN	P.V.P (€)
7,7	9,5	11,5	DRT50 RP0900 RP1800X RP2300FCX RT0700* RT0702C*	1	164379-4	008838111676	13,90
9,0	11,0	13,0		1	164775-6	008838111720	12,90
10,0	12,0	9,0		1	164388-3	0088381156356	11,85
11,0	12,7	13,0		1	164776-4	008838112062	13,40
14,5	16,0	13,0		1	344364-5	0088381141222	2,60
18,0	20,0	13,0		1	164393-0	008838111683	16,00
24,0	27,0	13,0		1	164470-8	008838111690	13,00
25,0	29,0	150,0		1	163080-8	008838111645	10,80
27,0	30,0	13,0		1	164471-6	008838111706	11,05
37,0	40,0	11,5		1	165046-4	0088381161237	16,00

* Con base de superficie

3. Para modelos RP0910, RP110C

3



A (mm)	B (mm)	C (mm)	Modelos	Unds.	Código	EAN	P.V.P (€)
9,0	11,0	11,5	RP0910 RP110C	1	193331-5	0088381159906	13,40
10,5	12,0	14,0		1	193332-3	0088381156615	9,55
14,5	16,0	11,5		1	193334-9	0088381159920	10,80
18,0	20,0	13,0		1	193335-7	0088381159937	16,20
22,0	14,0	13,0		1	193340-4	0088381159982	13,40
24,0	27,0	13,0		1	193336-5	0088381159944	12,35
27,0	30,0	13,0		1	193338-1	0088381159968	12,90
37,0	40,0	13,0		1	193339-9	0088381159975	14,40

Guía de plantilla completa

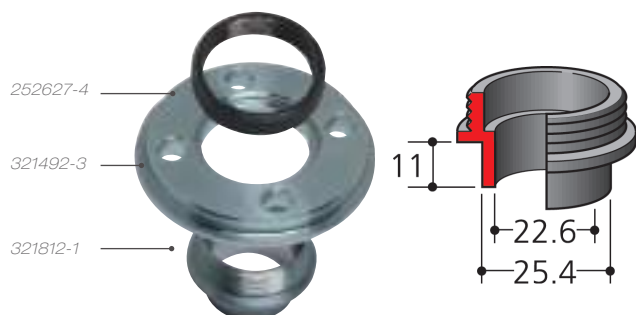

Modelo	Ø (mm)	Modelos	Unds.	Código	EAN	P.V.P (€)
Tuerca	M30	DRT50 RP0900 RP1800X RP2300FCX RT0700* RT0702C*	1	252627-4	008838111782	10,30
Adaptador	-		1	321492-3	008838111799	15,45
Casquillo	25,4mm		1	321812-1	008838111805	10,05

* Con base de superficie



Guías de carril y accesorios



Pieza para unir dos carriles



Guía carril



Funda para carril guía

Descripción	Longitud (m)	Unds.	Código	EAN	P.V.P (€)
Pieza para unir dos carriles	-	1	198885-7	0088381497046	25,00
Guía carril	1	1	199140-0	0088381528672	45,00
	1,4	1	194368-5	0088381313353	71,00
	1,9	1	194925-9	0088381354790	109,00
	3	1	194367-7	0088381335201	185,00
Funda para carril guía	1	1	E-05670	0088381567183	46,00
	1,4	1	E-05664	0088381567176	53,00
	1,9	1	E-10920	0088381581523	83,00
	3	1	E-10936	0088381581530	103,00

Mordazas para carril guía



Descripción	Unds.	Código	EAN	P.V.P (€)
Set de sujeción para carril guía.	2	194385-5	0088381314084	28,00

Adaptador para guía de carril



Modelos	Unds.	Código	EAN	P.V.P (€)
RP0910 RP110C RP1800 RP2300FC RP0900 RT0700* RT0702C*	1	194579-2	0088381352611	36,00

* Con base de superficie



Accesorios para fresadora RT0700C multifunción y DRT50

Base recta

Placa para base



* Includida placa base

Descripción	Modelo	Unds.	Código	EAN	P.V.P (€)
Base	DRT50 RT0700C RT0702C	1	196613-4	0088381446136	26,00
Placa para base		1	454842-8	-	2,40



Base para superficie

Placa para base



* Includida placa base

Descripción	Modelo	Unds.	Código	EAN	P.V.P (€)
Base	DRT50 RT0700C RT0702C	1	195563-0	0088381376099	70,00
Placa para base		1	450819-1	-	3,00



Base inclinable 30° a 45°

Placa para base



* Includida placa base

Descripción	Modelo	Unds.	Código	EAN	P.V.P (€)
Base	DRT50 RT0700C RT0702C	1	198987-9	0088381525848	31,00
Placa para base		1	413150-6	-	2,50



Base eje desplazado

Placa para base



* Includida placa base

Descripción	Modelo	Unds.	Código	EAN	P.V.P (€)
Base	DRT50 RT0700C RT0702C	1	195562-2	0088381376082	82,00
Placa para base		1	413148-3	-	4,50



Guías de recorte

1



2



3



Tipo	Modelo	Unds.	Código	EAN	P.V.P (€)
1	3709 3710 DRT50 RT0700C RT0702C	1	122703-7	0088381207300	3,50
2	RP1800X RP2300FCX	1	123022-4*	0088381115643	13,00
3	RP0900 RT0700C** RT0702C DRT50	1	STEX122385	0088381111164	36,00
	3601B	1	122343-1	0088381111621	25,00

* Necesario utilizar tope ajustable

** Con base de superficie

Tornillo de fijación



Descripción	Unds.	Código	EAN	P.V.P (€)
Fija la profundidad cuando utilizamos la fresadora invertida en una mesa.	1	266491-7	-	2,05

Bases



Base recta

Base inclinada

Tipo	Modelo	Unds.	Código	EAN	P.V.P (€)
Base recta	3707/F/FC	1	123544-4	-	28,00
Base inclinada		1	193904-4	0088381164726	46,00
Base recta con goma	3709 3710	1	194268-9	0088381248846	13,10
Base recta		1	194267-1	0088381248839	15,50
Base inclinada		1	194270-2	0088381248860	41,00

Tope ajustable



* Para colocar guía de recorte.

Modelos	Unds.	Código	EAN	P.V.P (€)
RP1800 RP2300FC	1	122700-3	0088381347327	17,50
DRT50 RT0700C RT0702C	1	195564-8	0088381411530	6,10

Adaptadores de aspiración



Modelos	Unds.	Código	EAN	P.V.P (€)
3612 3612C	1	415412-8	0088381155014	5,00
RP1800X RP2300FCX	1	194934-8	0088381356756	10,80
DRT50* RP0900 RT0700C* RT0702C*	1	194733-8	0088381358972	2,25
DRT50 RT0700C RT0702C	1	195559-1	0088381411295	3,35

* Con base de superficie

Guías paralelas



Guía paralela con regulación milimétrica

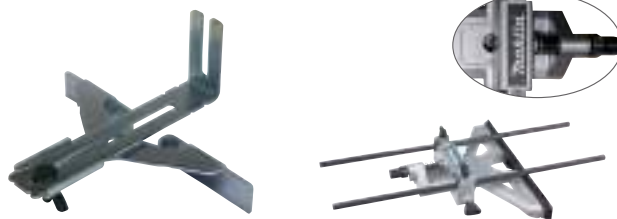

195136-9

Modelos	Unds.	Código	EAN	P.V.P (€)
3707FC 3709 3710 DRT50 RT0700C RT0702C	1	122391-0	0088381115674	6,30
RP0900 RP0910 RP1100C	1	164834-6	0088381111737	4,25
3612C 3612	1	342428-9	0088381115667	6,85
DRT50* RP0900 RT0700* RT0702C* RP1100C RP1800 RP2300FCX	1	195136-9	0088381360623	53,00

* Con base de superficie

Decapar





• **HG5030K**



• **HG6031VK**



• **HG6531CK**







Accesorios para decapadores HG5030, HG6031V y HG6531V

Descripción		HG5030K	HG6031VK	HG6531VK	Unds.	Código	EAN	P.V.P (€)
		✓	✓	✓	1	PR00000029	0088381527934	7,65
		✓	✓	✓	1	PR00000028	0088381527927	7,65
		✓	✓	✓	1	PR00000030	0088381527941	9,85
		-	✓	✓	1	PR00000031	0088381527958	8,20
		-	-	✓	1	PR00000039	0088381528030	9,00
		-	-	✓	1	PR00000032	0088381527965	16,30
		-	-	✓	1	PR00000033	0088381527972	17,90
		-	-	✓	1	PR00000034	0088381527989	7,65
		✓	✓	✓	1	PR00000035	0088381527996	10,35
		✓	✓	✓	1	PR00000041	0088381528054	20,75

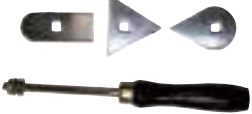

Accesorios para decapadores HG5012, HG551 y HG651CK

Descripción	HG5012K	HG551VK	HG651CK	Unds.	Código	EAN	P.V.P (€)
 Boquilla de reducción ø 20mm	-	✓	✓	1	P-71439	0088381702027	7,45
 Boquilla reflectora	✓	✓	✓	1	P-71445	0088381702034	7,45
 Boquilla para soldar a solapa	-	-	✓	1	P-71489	0088381702072	11,35
 Set de paletas	✓	✓	✓	1	P-71554	0088381702140	19,55
 Reflector para soldadura	-	-	✓	1	P-71495	0088381702089	13,90

Plástico de soldadura



Características	Longitud (mm)	Unds.	Código	EAN	P.V.P (€)
Plástico polipropileno	230	20	P-71510	0088381702102	24,00
Plástico polietileno			P-71526	0088381702119	24,00
Plástico acrilonitrilo			P-71532	0088381702126	24,00



Tornillos y clavos



Amplia gama de atornilladores autoalimentados, clavadoras y grapadoras Makita



Ristra de tornillos para autoalimentados



Tornillo para tabiquería seca sobre guía metálica

Ø (mm)	Longitud (mm)	Tipo de rosca	Tratamiento	BFR440	BFR550	6842	6844	uds.	Código	EAN	P.V.P. (€)
3,5	25	Fina	Fosfatado	✓	✓	X	X	1.000	F-31227	0088381291781	15,20
3,5	35			✓	✓	X	X		F-31230	0088381291712	16,75
3,9	25			✓	✓	✓	X		F-30913	0088381291477	15,70
3,9	41			✓	✓	✓	X		F-31166	0088381291729	20,10

Tornillo para tabiquería seca sobre guía de madera

Ø (mm)	Longitud (mm)	Tipo de rosca	Tratamiento	BFR440	BFR550	6842	6844	uds.	Código	EAN	P.V.P. (€)
3,9	41	Gruesa	Fosfatado	✓	✓	✓	X	1.000	F-31182	0088381291743	26,00
3,9	55			X	X	✓	✓		F-31140	0088381291705	21,00

Tornillo anticorrosión

Ø (mm)	Longitud (mm)	Tipo de rosca	Tratamiento	BFR440	BFR550	6842	6844	uds.	Código	EAN	P.V.P. (€)
3,9	32	D/G	Anticorrosión	✓	✓	X	X	1.000	P-38283	0088381973991	29,00



Tornillos para atornillador autoalimentado - AR410HR

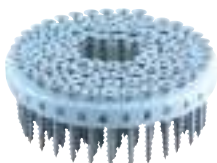

Ø caña (mm)	Ø cabeza (mm)	Longitud (mm)	Tipo	Rosca	Modelo	uds. / caja	Código	EAN	P.V.P. (€)
3,5	8,2	28	PH2	Fina	AR410HR	2.000	F-32843	0088381293402	35,00
3,5		41		Fina			F-32856	0088381293419	39,00
3,8		25		Grueso			F-32869	0088381293426	32,00
3,8		28		Grueso			F-32872	0088381293433	33,00
3,8		32		Grueso			F-32885	0088381293440	35,00
3,8		41		Grueso			F-32898	0088381293457	41,00

Clavos 0,6mm (23Ga) Inox - DPT351 y DPT353



Ø (mm)	Longitud (mm)	Tipo	Galga	Material	Modelos	uds. / caja	Código	EAN	P.V.P. (€)
0,6	18	Pin	23Ga	Inox	DPT351 DPT353	10.000	F-32142	0088381292702	25,00
	25						F-32155	0088381292719	29,00
	30						F-32168	0088381292726	33,00
	35						F-32171	0088381292733	37,00

Clavos 0,6mm (23Ga) Acero - DPT351 y DPT353



Ø (mm)	Longitud (mm)	Tipo	Galga	Material	Modelos	uds. / caja	Código	EAN	P.V.P. (€)
0,6	18	Pin	23Ga	Acero	DPT351 DPT353	10.000	F-31825	0088381292382	13,40
	25						F-31838	0088381292399	14,40
	30						F-31841	0088381292405	16,20
	35						F-31854	0088381292412	18,00

Clavos 1,2mm (18Ga) - AF505N, DBN500 y DFN350



Ø (mm)	Longitud (mm)	Tipo	Galga	Modelos	uds. / caja	Código	EAN	P.V.P. (€)
1,2	20	Brad	18Ga	AF505N DBN500 DFN350*	5.000	P-45923	0088381976367	11,55
	25					P-45939	0088381976374	13,20
	30					P-45945	0088381976381	15,40
	40					P-45951	0088381976398	16,50
	50					P-45967	0088381976404	19,25

*Solo hasta clavo de 30mm

Clavos multimaterial - AN250HC

- El clavo de hormigón tiene una guía (casquillo de plástico) que impide la inclinación del clavo y permite un disparo recto, clavos de 19 a 25 mm y sin inclinación.
- Recomendaciones: No clavar directamente sobre el hormigón, colocar el clavo a 10 cm del extremo del hormigón, colocar los clavos a 10 cm de distancia como mínimo.



Ø caña (mm)	Ø cabeza (mm)	Longitud (mm)	Tipo	Modelos	uds. / caja	Código	EAN	P.V.P. (€)
2,5	6,3	19	Liso	AN250HC	1.000	F-33562	0088381294126	44,00
2,5		22				F-33575	0088381294133	53,00
2,5		25				F-33588	0088381294140	55,00
3		19				F-33591	0088381294157	84,00

Clavos multimaterial. Cada caja contiene un bote de gas. - GN420C



Ø (mm)	Longitud (mm)	Calidad	Tipo	uds. GAS	Modelos	uds. / caja	Código	EAN	P.V.P. (€)
3,1	15	Premium	Para todo tipo de materiales	1	GN420C	1.000	196285-5	0088381422932	82,00
	17						196286-3	0088381422949	82,00
	22						196287-1	0088381422956	82,00
	27						196288-9	0088381422963	82,00
	32						196289-7	0088381422970	82,00

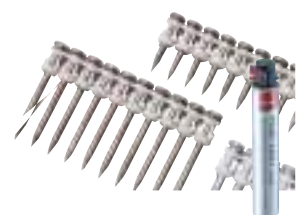

Ø (mm)	Longitud (mm)	Calidad	Tipo	uds. GAS	Modelos	uds. / caja	Código	EAN	P.V.P. (€)
2,6	20	Estándar	Para todo tipo de materiales excepto hormigón	1	GN420C	1.000	196290-2	0088381422987	76,00
	25						196291-0	0088381422994	76,00
	30						196292-8	0088381423007	76,00
	35						196293-6	0088381423014	76,00
	40						196294-4	0088381423021	76,00

Cargador de clavos - GN420C



Modelos	uds. / caja	uds. por carga	Código	EAN	P.V.P. (€)
GN420C	1	20	196246-5	0088381417891	201,00

Grapas

Grapas de 90 - AT638



Ancho grapa (mm)	Longitud (mm)	Tipo	Modelos	uds. / caja	Código	EAN	P.V.P. (€)
1/4"	15	18Ga	AT638	5.000	P-45864	0088381976305	14,85
	18				P-45870	0088381976312	15,95
	25				P-45886	0088381976329	19,80
	30				P-45892	0088381976336	23,00
	35				P-45901	0088381976343	25,00
	38				P-45917	0088381976350	28,00

Grapas para máquinas a batería



Ancho grapa (mm)	Longitud (mm)	Modelos	uds. caja	Código	EAN	P.V.P. (€)
------------------	---------------	---------	-----------	--------	-----	------------

DST221

10	10	DST221	5.000	F-32647	0088381293204	13,90
	13			F-32650	0088381293211	12,35
	16			F-32663	0088381293228	16,50
	19			F-32676	0088381293235	18,55
	22			F-32689	0088381293242	19,55

ST113D y DST112

10	7	ST113D DST112	25.000	F-81518	0088381342308	23,50
	10		15.000	F-81521	0088381342322	18,00

Bote de aceite



Contenido	Modelos	uds.	Código	EAN	P.V.P. (€)
30 ml	Todos	1	181434-7	0088381194747	1,25

Protector de punta BPT350



Descripción	uds.	Código	EAN	P.V.P. (€)
Evita marcar la madera durante el clavado.	1	419525-7	0088381341097	1,45



VARIOS

Bote de gas



Modelos	uds.	Código	EAN	P.V.P. (€)
GN900 GN420C	1	242094-1	0088381415712	16,50

Bote de gas



Modelo	uds.	Código	EAN	P.V.P. (€)
GF600	1	242088-6	0088381401968	14,40

Gafas de seguridad



Modelos	uds.	Código	EAN	P.V.P. (€)
Todos	1	195246-2	0088381365413	4,40

Accesorios para alta presión

Mangueras - AC310H



B-80014

Contenido	Modelo	uds.	Código	EAN	P.V.P. (€)
Manguera 30m	AC310H	1	B-80020	0088381350761	295,00
Manguera 15m		1	B-80014	0088381350754	201,00
Manguera 7,5m		1	B-80036	0088381350778	164,00

Aceite lubricante



Modelos	uds.	Código	EAN	P.V.P. (€)
GN900 GN420C	1	242077-1	0088381351973	10,80

Limpiador



Modelos	uds.	Código	EAN	P.V.P. (€)
GN900 GN420C	1	242075-5	0088381351966	19,55

Kit limpiador



Modelos	uds.	Código	EAN	P.V.P. (€)
GN900 GN420C GF600	1	194852-0	0088381351959	45,00

Carro de transporte - AC310H



Contenido	Modelo	uds.	Código	EAN	P.V.P. (€)
Carro de transporte	AC310H	1	HY00000212	0088381351188	193,00

Aspiración



HEPA
filtro



Amplia gama de aspiradores a batería. Potentes - Ligeros - Manejables.



LXT
Lithio-ion EXTREMA TECNOLOGIA

XGT

CXT



18V
LITHIO-ION

BL
MOTOR

CXT

HEPA
filtro

20V

AWS

Para más información consulta el catálogo de herramientas.



Mecanismo de limpieza de la bolsa de papel para polvo eficiencia laboral (solo DVC660 / DVC665)

Incluso al aspirar polvo de hormigón, este tiende a obstruir los filtros. La activación de este mecanismo permite recoger aproximadamente hasta 4,0L, el 70% de la capacidad de la bolsa de papel para polvo. (aproximadamente 3,0 L [50%] cuando no se activa

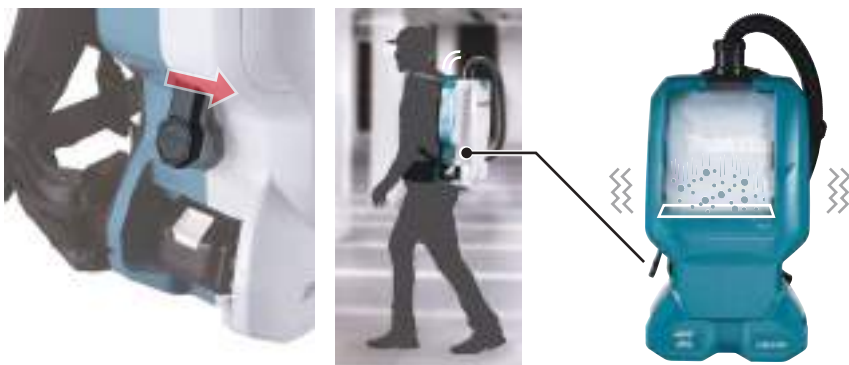

Este mecanismo se puede accionar:

- Automáticamente por la vibración provocada al caminar.
- Manualmente accionando una palanca que está situada en el lateral.

Mando controlador



DVC660 / DVC661

DVC660 / DVC661

Tecnología de conexión inalámbrica



• La función de activación inalámbrica automática permite un funcionamiento limpio y cómodo. Al conectar una herramienta compatible al aspirador, puede accionar el aspirador junto con el arranque de la herramienta.



• AWS se conecta a la herramienta eléctrica mediante Bluetooth.

• La marca denominativa y los logotipos de Bluetooth® son marcas comerciales registradas propiedad de Bluetooth SIG, Inc. y cualquier uso de dichas marcas por parte de Makita se realiza bajo licencia. Otras marcas comerciales y nombres comerciales pertenecen a sus respectivos propietarios.

El aire que sale es tan limpio como el del filtro de aire.

El filtro HEPA se utiliza como filtro principal para capturar partículas muy finas con eficacia.



El sistema eficiente de filtración HEPA de tres etapas captura el 99,97 % de partículas de 3 micras o más grandes.



DVC660 / DVC665

DVC261 / DVC265



Accesorios para aspiradores

DVC150L
DVC154L
DVC155LZX2
DVC157LZX3



DVC860L
DVC862L
DVC864L



DVC260
DVC261
DVC265



DVC660
DVC665

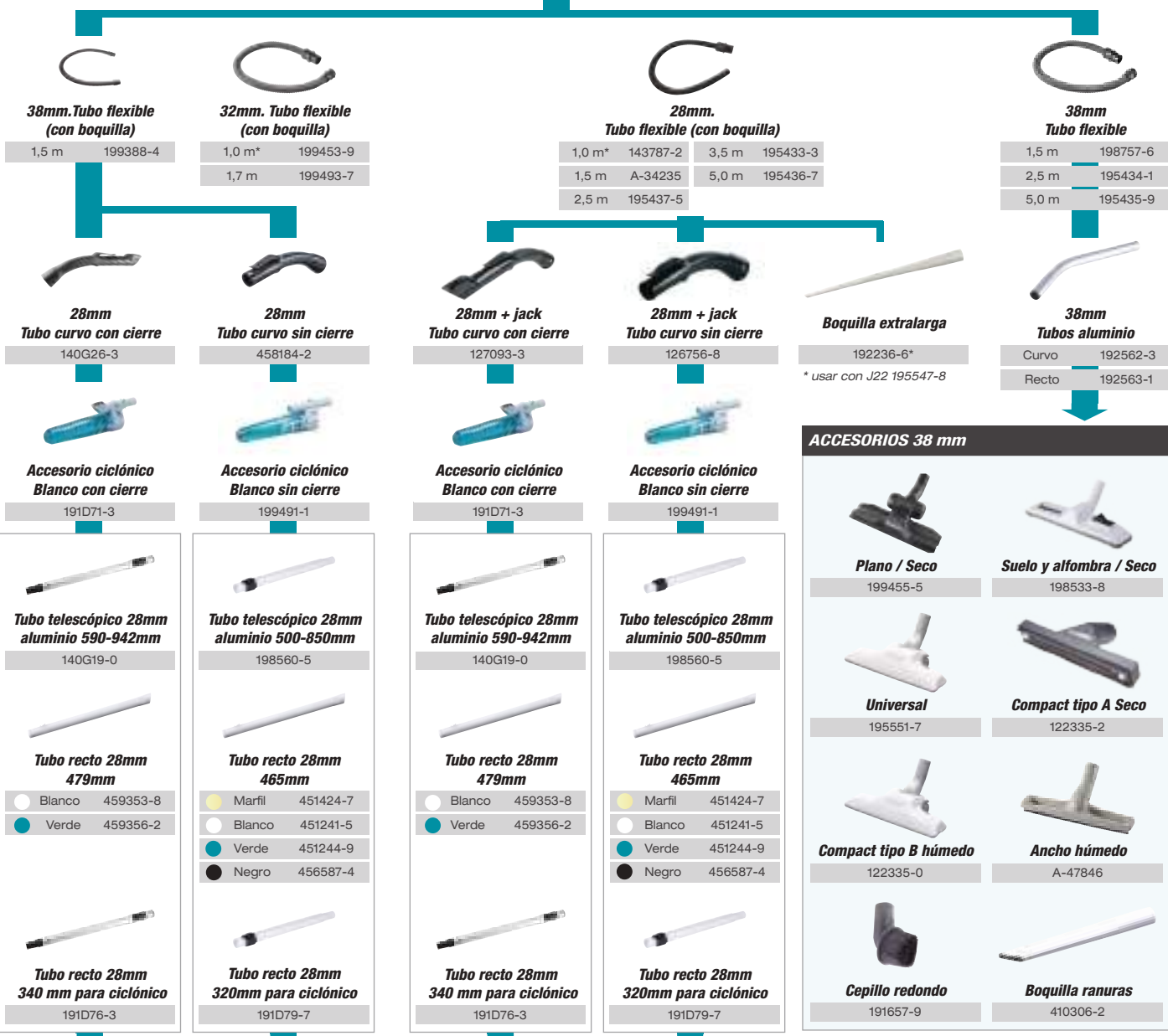

ACCESORIOS 28 mm (seco)

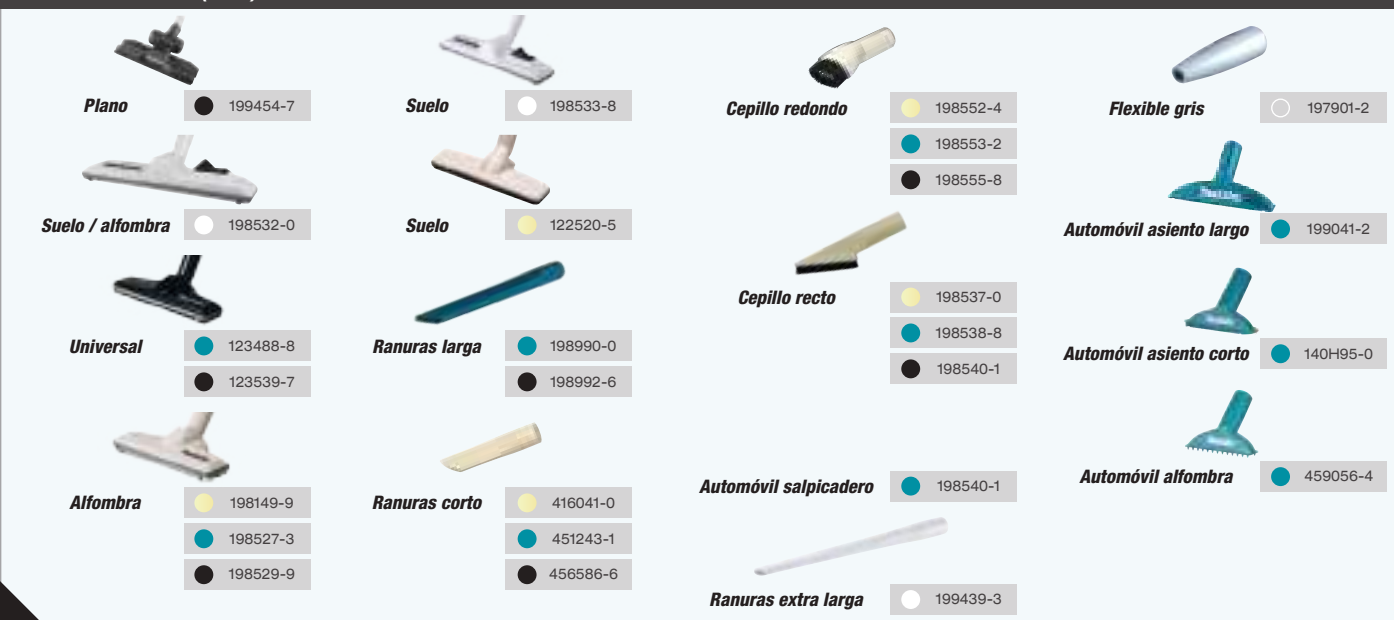

Accesorios para aspiradores

DVC750L



Adaptador
418500-0

DCL281F



Accesorio ciclónico Blanco con cierre
191D71-3

DCL180
DCL180ZB
CL180FD
CL106D



Accesorio ciclónico Blanco sin cierre
199491-1

DCL184
CL121D



Boca de soplado completa
140J64-3

Tubo telescópico 28mm aluminio 500-850mm
198560-5

Tubo telescópico 28mm aluminio 590-942mm
140G19-0

Tubo telescópico 28mm aluminio 500-850mm
198560-5

Tubo flexible 28mm 465mm

Tubo recto 28mm 465mm

- Marfil 451424-7
- Blanco 451241-5
- Verde 451244-9
- Negro 456587-4

Tubo recto 28mm 479mm

- Blanco 459353-8
- Verde 459356-2

Tubo flexible 28mm 465mm

- Marfil 198544-3
- Verde 198545-1
- Negro 198547-7

Tubo recto 28mm 465mm

- Marfil 451424-7
- Blanco 451241-5
- Verde 451424-7
- Negro 451241-5

Tubo recto 28mm 320mm para ciclónico
191D79-7

Tubo recto 28mm 340 mm para ciclónico
191D76-3

Tubo recto 28mm 320mm para ciclónico
191D79-7

ACCESORIOS 28 mm (seco)



Plano ● 199454-7



Suelo ● 198533-8

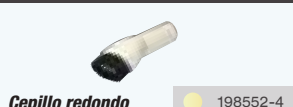

- 198552-4
- 198553-2
- 198555-8



Flexible gris ○ 197901-2



Suelo / alfombra ● 198532-0



Suelo ● 122520-5

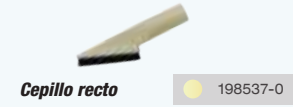

- 198537-0
- 198538-8
- 198540-1

Automóvil asiento largo ● 199041-2



- 123488-8
- 123539-7



- 198990-0
- 198992-6

Automóvil asiento corto ● 140H95-0

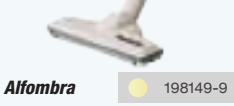

- 198149-9
- 198527-3
- 198529-9



- 416041-0
- 451243-1
- 456586-6

Automóvil salpicadero ● 198540-1

Automóvil alfombra ● 459056-4

Ranuras extra larga ● 199439-3

***SET COMPLETO**

195439-1

Tubo flexible 38mm x 2,5m
Tubo recto y curvo
Pie de aspiración
Boquilla de ranuras



SOPORTE

199971-7

Válido para
DCL281F
DCL180
DCL180ZB



Accesorios para aspiradores

VC3012L
VC4210L



VC2012L
VC2512L
VC3011L



32mm.
Tubo flexible

P-84084



Tubo curvo inox.

P-70346



Tubos rectos
35 x 500mm (2 unds)

P-70437



Tubos rectos
35 x 350mm (3 unds)

W107418350



32mm.
Tubo flexible

3,5 m P-81739



Tubo curvo

P-72908



Tubos rectos
35 x 520mm (2 unds)

P-72942

ACCESORIOS 32 mm



Boca para ranuras
5 x 300mm

W6084



Pie seco / húmedo
36 x 300mm

P-81789



Cepillo para alfombra

P-70471



Pie para alfombra
275mm Seco / húmedo

P-70465



Pie extra largo
405mm Seco / húmedo

P-72964



Pie largo
350mm Seco / húmedo

P-72958



Boquilla flexible

W5067

ACCESORIOS 32 mm



Boca para ranuras
35x200mm

W29541*



Pie seco / húmedo
36 x 260mm

W107402706



Cepillo para alfombra

P-70471



Pie para alfombra
275mm Seco / húmedo

P-70465



Pie extra largo
405mm Seco / húmedo

P-72964



Pie largo
350mm Seco / húmedo

P-72958



Boquilla flexible

W5067

Kit completo de aspiración



Descripción	Código	EAN	P.V.P. (€)
Makita SET - Tubo ø 36 x 4000 mm. - Tubo curvo cromo. - 2 x tubo recto 500 mm cromo. - Pie de 350 mm para la limpieza de suelos-	P-70328	0088381700887	108,00
Conexión doble	W15331	-	31,00
Boquilla rotativa para tubo de 36 mm	P-70390	0088381700955	14,95
Boquilla rotativa para tubo de 27 mm	P-70409	0088381700962	14,40



Listado de códigos y precios - Accesorios para aspiradores

Código	EAN	P.V.P. (€)
122335-0	0088381126878	14,40
122335-2	-	*
122520-5	0088381141260	8,25
123488-8	0088381589765	10,30
123539-7	-	10,30
126756-8	0088381548403	8,45
127093-3	0088381541619	10,80
140G19-0	0088381541626	20,70
140G26-3	0088381584180	9,20
140H95-0	0088381544887	5,15
140J64-3	0088381544924	7,60
143787-2	0088381485838	30,00
191657-9	0088381142892	14,40
191D71-3	0088381556637	39,00
191D76-3	0088381556668	5,95
191D79-7	0088381556699	4,35
192236-6	0088381117746	5,65
192562-3	0088381141116	9,10
192563-1	0088381141123	8,65
195433-3	0088381370264	59,00
195434-1	0088381370271	59,00
195435-9	0088381370288	109,00
195436-7	0088381370295	72,00
195437-5	0088381370301	47,00
195439-1	0088381370493	100,00
195551-7	0088381370394	27,00
197901-2	0088381468084	6,55
198149-9	0088381475020	14,40
198527-3	0088381484299	14,40
198529-9	0088381484312	14,40
198532-0	0088381484329	23,00
198533-8	0088381484336	24,00

Código	EAN	P.V.P. (€)
198537-0	0088381484374	7,20
198538-8	0088381484381	5,40
198540-1	0088381484404	5,40
198544-3	0088381484442	8,25
198545-1	0088381484459	8,25
198547-7	0088381484473	8,25
198552-4	0088381484527	5,40
198553-2	0088381484534	5,40
198555-8	0088381484558	5,40
198559-0	0088381484572	18,75
198560-5	0088381484589	23,00
198990-0	0088381519335	2,20
198992-6	0088381519359	2,20
199041-2	0088381524995	7,20
199388-4	0088381533874	59,00
199439-3	0088381537162	3,80
199453-9	0088381539043	16,45
199454-7	0088381539685	29,00
199455-5	0088381539692	29,00
199491-1	0088381536905	36,00
199493-7	0088381539142	18,65
199971-7	0088381546171	5,25
191M50-5	0088381571982	54,00
410306-2	0088381123709	3,40
416041-0	0088381141284	1,30
451241-5	0088381362733	2,15
451243-1	0088381453769	0,80
451244-9	-	4,05
451424-7	0088381366847	2,20
456586-6	-	1,10
456587-4	-	1,95
458184-2	0088381536028	*

Código	EAN	P.V.P. (€)
459056-4	0088381544894	2,50
459353-8	-	2,30
459356-2	0088381556897	2,30
A-34235	0088381163293	35,00
A-47846	0088381313360	32,00
P-70346	0088381700900	30,00
P-70437	0088381700993	35,00
P-70465	0088381701020	31,00
P-70471	0088381701037	10,05
P-72942	0088381703604	28,00
P-72964	0088381703628	60,00
P-81745	0088381457569	21,00
P-81789	0088381457385	26,00
P-84084	0088381483896	65,00
P-72908	0088381703567	24,00
P-72958	0088381703611	48,00
P-72964	0088381703628	60,00
P-81739	0088381457552	36,00
P-81745	0088381457569	21,00
P-81789	0088381457385	26,00
P-84084	0088381483896	65,00
W107402706	-	14,40
W107418350	0088381490122	33,00
W29541	-	4,40
W5067	3240890251527	13,15
W6084	0088381431095	5,15



* Consultar P.V.P.

Filtros para aspiradores

	Soporte de filtro	Filtro	Espuma filtro	Prefiltro
DVC860L DVC862L DVC150L DVC155L	-	-	-	
	-	-	-	140248-3
DVC864L DVC154L DVC157L	-			
	-	197166-6	423398-2	140253-0
DVC260 DVC261 DVC265	-		-	-
	-	127725-2	-	-
DVC660 DVC665	-		-	-
	-	191D12-9	-	-
DVC750L	-			
	-	162518-0	422449-8	162635-6
DCL281F			-	
	458467-0	198915-4	-	198751-8
DCL180Z DCL180ZB CL108FD CL106FD			-	
	458467-0	443060-3	-	451208-3
DCL184 CL121D	-	-		-
	-	-	422440-6	-
DRC200	-		-	-
	-	SH00000213	-	-
VC4210L	-		-	-
	-	W107413540	-	-
DVC560	-		-	-
	-	191E39-5	-	-
VC2012L VC2512L VC3011L VC3012L	-		-	-
	-	P-70219	-	-

Descripción	Unds.	Código	EAN	P.V.P. (€)
Filtro	1	127725-2	0088381575621	9,00
Prefiltro	1	140248-3	0088381469999	14,75
Prefiltro	1	140253-0	-	18,50
Filtro	1	162518-0	0088381547864	18,00
Prefiltro	1	162635-6	-	9,80
Filtro	1	191D12-9	0088381557719	11,00
Filtro	1	197166-6	0088381449953	59,00
Prefiltro	1	198751-8	0088381490450	4,10
Filtro	1	198915-4	0088381497497	7,00
Espuma filtro	1	422440-6	-	0,50
Espuma filtro	1	422449-8	-	2,75
Espuma filtro	1	423398-2	0088381536196	9,25
Filtro	1	443060-3	0088381123853	1,00
Prefiltro	1	451208-3	0088381359993	1,80
Soporte de filtro	1	458467-0	-	0,50
Filtro	1	P-70219	0088381700771	36,00
Filtro	1	SH00000213	0088381479189	80,00
Filtro	1	W107413540	-	71,00
Filtro HEPA	1	191E39-5	0088381565431	10,90

Prefiltro DCL281



Descripción	Unds.	Código	EAN	P.V.P. (€)
Prefiltro	1	199966-0	0088381546515	6,75



Bolsas para aspiradores

	Bolsa de papel	Bolsa plástico	Bolsa nylon	Bolsa reutilizable
DVC860L DVC862L DVC150L DVC155L	-	-		-
	-	195432-5	195557-5	-
DVC864L DVC154L DVC157L	-			-
	-	195432-5	195557-5	-
DVC260 DVC261 DVC265	-	-		
	-	-	197903-8	197899-3
DVC660 DVC665	-	-		
	-	-	191C26-2	191C30-1
CL106FD CL108FD DCL180Z DCL180ZB DCL184		-	-	-
	194566-1	-	-	-
VC4210L				-
	P-70203	W107418355	W107418353	-
VC3011L VC3012L				-
	P-70194	P-70306	P-72899	-
VC2012L VC2512L VC3011L	-			-
	-	P-70297	P-78293	-

Descripción	Unds.	Código	EAN	P.V.P. (€)
Bolsa nylon	10	191C26-2	-	21,05
Bolsa reutilizable	1	191C30-1	-	18,60
Bolsa de papel	5	194566-1	0088381351270	3,75
Bolsa plástico	10	195432-5	-	7,05
Bolsa nylon	5	195557-5	0088381370479	25,00
Bolsa reutilizable	1	197899-3	0088381468060	26,00
Bolsa nylon	10	197903-8	0088381468107	29,00
Bolsa de papel	5	P-70194	0088381700757	32,00
Bolsa de papel	5	P-70203	0088381700764	61,00
Bolsa plástico	5	P-70297	0088381700856	28,00
Bolsa plástico	5	P-70306	0088381700863	63,00
Bolsa tela	5	P-72899	0088381703550	26,00
Bolsa nylon	5	P-78293	0088381709040	35,00
Bolsa papel	5	W107418353	0088381490153	36,00
Bolsa plástico	5	W107418355	0088381490177	33,00
Bolsa nylon	10	191D63-2	0088381565424	18,55

Adaptador AWS























- El adaptador inalámbrico Bluetooth WUT02 permite el encendido y apagado inalámbrico de aspiradoras eléctricas Makita. Incluye dispositivo AWS.



Descripción	Unds.	Código	EAN	P.V.P. (€)
WUT02	1	199773-1	0088381542807	232,00





Conexiones para aspiradores

 DVC260 DVC261 DVC265	 DVC660 DVC665 DVC150L DVC154L	 DVC155LZX2 DVC157LZX3	 DVC860L DVC862L DVC864L	 DVC750L	 VC3012L VC4210LX	 VC2012L VC2512L VC3011L					
 28mm x 1M. 143787-2 28mm x 1,5M A-34235 28mm x 3,5M 195433-3 28mm x 5 M 195436-7	 38mm x 1,5M 198757-6 38mm x 2,5M 195434-1 38mm x 5 M 195435-9				 32mm x 4M P-84084	 32mm x 3,5M P-81739					
 Ø 22mm 195547-8	 Ø 38mm 195545-2	 Ø 24mm 195546-0	 Ø 24mm 195548-6	 Ø 22mm 195548-6	 Ø 24mm 195546-0	 Ø 38mm W107418688	 Ø 24mm P-70378	 Ø 22mm 192349-3	 Ø 38mm P-70421	 Ø 24mm P-81745	 Ø 22mm 192349-3

ACCESORIOS

 Colector de polvo 230mm 198440-5	 Colector de polvo 125mm 196845-3	 Colector de polvo para discos de diamante 195386-6	 Extractor de polvo para martillos ligeros *HR2230 / HR2460 / HR2470 193472-7	 Kit aspiración para multiherramienta *DTM51 196765-1	 Adaptadores de aspiración *RP1800X / RP2300FCX 194934-8
 Colector de polvo para martillos combinados 195866-2	 para demoledores 197168-2	 Adaptador para sierras de calar 417853-4	 Adaptador para sierras circulares 415816-4	 Colector de polvo *3706 / DCO180 193449-2	

Descripción	Unds.	Código	EAN	P.V.P. (€)	Descripción	Unds.	Código	EAN	P.V.P. (€)	Descripción	Unds.	Código	EAN	P.V.P. (€)
	1	195547-8	0088381370349	3,15		1	P-70378	0088381700931	23,00		1	P-72936	0088381703598	11,85
	1	195545-2	0088381370325	6,75		1	192349-3	0088381126229	7,70		1	192613-2	0088381140843	14,40
	1	195546-0	0088381370332	4,20		1	P-70421	0088381700986	19,05		1	P-19299	0088381945905	4,90
	1	195548-6	0088381370356	8,25		1	P-81745	0088381457569	21,00		1	191M78-3	0088381575782	9,30
	1	W107418688	0088381519946	28,00		1	P-70415	0088381700979	9,80		1	191M79-1	0088381575799	9,30

Conexiones para aspiradores

ASPIRADORES

Ø 38mm



Ø 24 mm



195546-0

Ø 22 mm



195548-6

Ø 28mm



Ø 38mm



195546-0

Ø 24mm



195546-0

Ø 22 mm



195547-8

Ø 32mm



Ø 24mm



P-81745

Ø 24mm



P-81745

J22



192349-3

Ø 32mm



Ø 24mm



P-70378

Ø 24mm



P-70378

J22



192349-3



Adaptador

Ø 24 mm

Modelos	Unds.	Código	EAN	P.V.P. (€)
HR4001C HR4011C HR4501C HR4511C	1	196074-8	0088381407632	105,00
HR4003C HR4013C	1	199142-6	0088381524339	100,00
HR5212C	1	196858-4	0088381441599	77,00
DHR400	1	199142-6	0088381524339	100,00

Sin adaptador

Manguera de 28mm

Modelos	Unds.	Código	EAN	P.V.P. (€)
HM1307C HM1317C HM1400 HM1812	1	197168-2	0088381449984	53,00

Adaptador

Ø 22 mm

Modelos	Unds.	Código	EAN	P.V.P. (€)
DHR242 DHR264 DHR280 DHR282 HR2630 HR2600 HR2300	1	195173-3	0088381361125	7,05
DHR243 DHR281 DHR283 HR2611FT HR2610T HR2631FT HR2630T	1	195179-1	0088381361194	8,40

Adaptador

Ø 22 mm

Modelos	Unds.	Código	EAN	P.V.P. (€)
HR2230 HR2460 HR2470	1	193472-7	0088381174022	46,00



Conexiones para aspiradores

AMOLADORAS

Modelo + accesorio

Aspirador + accesorio

Miniamoladoras
115 / 125mm



Colectores
de polvo



196845-3

Ø 38mm

Miniamoladoras
180 / 230mm



198440-5**

Ø 38mm



** Incluye boquilla 192613-2 en el equipo básico del accesorio.

Miniamoladoras
115 / 125mm



Colector de
polvo para
discos de
diamante



195239-9

Ø 38mm

Miniamoladoras
180 / 230mm



195385-8

Ø 38mm



Ø 38mm



DVC860L
DVC861L
DVC864L
DVC750L

DVC150L
DVC151L
DVC157L

No necesita adaptador

Ø 28mm



DVC261
DVC265
DVC660
DVC665

Ø 38mm



195545-2

Ø 32mm



VC2012L
VC2512L
VC3011L

Ø 38mm



P-70421

Ø 32mm



VC3012L
VC4210L





















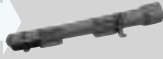

Ø 38mm



























W107418688

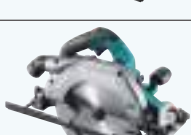





















Conexiones para aspiradores

























CEPILLOS y SIERRAS DE CALAR

Modelo + accesorio		Aspirador + accesorio
<p>DKP180 KP0800</p>   <p>451329-1</p>	<p>Ø 38mm</p>	<p>Ø 38mm</p>  <p>DVC860L DVC861L DVC864L DVC750L</p> <p>DVC150L DVC151L DVC157L</p>
<p>DKP181 KP0810/C</p> 	<p>Ø 38mm</p>	<p>Ø 22mm</p>  <p>195548-6</p>
		<p>Ø 28mm</p>  <p>DVC261 DVC265 DVC660 DVC665</p>
<p>4326 4327 4328 4329 JV100D JV0600</p> 	<p>Ø 22mm</p>	<p>Ø 38mm</p>  <p>195545-2</p> <p>Ø 22mm</p>  <p>195547-8</p>
<p>4350T 4350CT 4350FCT 4351T 4351CT 4351FCT</p>   <p>417853-4</p>	<p>Ø 22mm</p>	<p>Ø 32mm</p>  <p>VC2012L VC2512L VC3011L</p>
<p>DJV180 DJV181 DJV182</p>   <p>417853-4</p>	<p>Ø 22mm</p>	<p>Ø 38mm</p>  <p>P-70421</p> <p>Ø 24mm</p>  <p>P-81745</p> <p>J22</p>  <p>192349-3</p>
		<p>Ø 32mm</p>  <p>VC3012L VC4210LX</p> <p>Ø 38mm</p>  <p>W107418688</p> <p>Ø 24mm</p>  <p>P-70378</p> <p>J22</p>  <p>192349-3</p>

Modelo + accesorio	Aspirador + accesorio
<p>5903R 5903RK 5103R</p>   <p>192419-8*</p>	<p>Ø 38mm</p>  <p>DVC860L DVC861L DVC864L DVC750L</p> <p>DVC150L DVC151L DVC157L</p>
<p>5604R 5017RKB</p> 	<p>Ø 38mm</p>
<p>5008MG</p>   <p>450079-5*</p>	<p>Ø 38mm</p>  <p>195546-0</p>
<p>5603RK 5704R 5705RK</p>   <p>192420-3*</p>	<p>Ø 38mm</p>
<p>5143R</p>   <p>415816-4*</p>	<p>Ø 38mm</p>
<p>DHS660 DHS661</p> 	<p>Ø 24mm</p>
<p>DHS680</p> 	<p>Ø 24mm</p>  <p>DVC261 DVC265 DVC660 DVC665</p>
<p>DHS710 HS003G HS004G HS6601 HS7601</p>   <p>196520-1*</p>	<p>Ø 38mm Ø 24mm Ø 38mm</p>  <p>195545-2 195546-0 195545-2</p>
<p>DHS900</p> 	<p>Ø 24mm</p>
<p>DSP6000 DSP601 SP6000</p> 	<p>Ø 24mm</p>
<p>HS009G</p> 	<p>Ø 24mm</p>  <p>VC2012L VC2512L VC3011L</p>
	<p>Ø 38mm Ø 24mm</p>  <p>P-70421 P-81745</p>  <p>VC3012L VC4210LX</p> <p>Ø 38mm Ø 24mm</p>  <p>P-70378 W107418688</p>









* Incluido en equipo básico.

Modelo + accesorio		Aspirador + accesorio		
DLS111ZU DLS211ZU LS002G LS003G LS004G		Ø 24mm	 DVC860L DVC861L DVC864L DVC750L	
DLS600 DLS714		Ø 38mm		Ø 38mm DVC150L DVC151L DVC157L
LH1040F LH1201FL LS0815FLN LS1018LN		Ø 38mm		Ø 24mm  195546-0
LS1019L		Ø 38mm		Ø 22mm  195548-6
LS1040FN		Ø 38mm		Ø 28mm  DVC261 DVC265
LS1219L		Ø 38mm		Ø 22mm  195547-8
				Ø 24mm  195546-0
BTM50 DTM51 TM30D		Ø 22mm  199627-2	Ø 38mm  P-70421	
TM3000 TM3010		Ø 22mm  199624-8	Ø 24mm  P-81745	
No es posible conectar multiherramientas a VC3012L y VC4210Lx			Ø 32mm  VC3012L VC4210LX	
			Ø 38mm  W107418688	
			Ø 24mm  P-70378	

Modelo + accesorio		Aspirador + accesorio	
<p>DCO180 DCO181</p> 	 193449-2	<p>Ø 22mm</p>	<p>Ø 38mm</p>  <p>DVC860L DVC861L DVC864L DVC750L</p> <p>DVC150L DVC151L DVC157L</p>
<p>DRT50 RT0700C RT0702C</p> 	 195559-1	<p>Ø 38mm</p>	<p>Ø 22mm</p>  195548-6
<p>RPO900</p> 	 194733-8	<p>Ø 38mm</p>	
<p>RP1110C</p> 	 122615-4	<p>Ø 22mm</p>	<p>Ø 28mm</p>  <p>DVC261 DVC265 DVC660 DVC665</p> <p>Ø 38mm Ø 22mm</p>  195545-2  195547-8
<p>RP1800X RP2300FC</p> 	 194934-8	<p>Ø 38mm</p>	
			<p>Ø 32mm</p>  <p>VC2012L VC2512L VC3011L</p> <p>Ø 38mm Ø 24mm J22</p>  P-70421  P-81745  192349-3
			<p>Ø 32mm</p>  <p>VC3012L VC4210LX</p> <p>Ø 38mm Ø 24mm J22</p>  W107418688  P-70378  192349-3

Conexiones para aspiradores

LIJADORAS

Modelo + accesorio		
9032		Ø 22mm 122652-8
9031 9046		Ø 22mm
9404 9902 9903 9910 9911 9920		Ø 22mm
9403 9921		Ø 22mm
BO3711 BO4900 BO4901 BO4556 BO4565 BO4566		Ø 22mm
BO5030 BO5031 BO5040 BO5041 BO6030 BO6040 DBO180 DBO380 DBO381		Ø 22mm
BO6050		Ø 24mm
DSL800		Ø 38mm



Aspirador + accesorio

Ø 38mm			
			
DVC860L DVC861L DVC864L DVC750L		DVC150L DVC151L DVC157L	
Ø 24mm	Ø 22mm		
			
195546-0	195548-6		
Ø 28mm			
			
DVC261 DVC265		DVC660 DVC665	
Ø 22mm	Ø 24mm	Ø 38mm	Ø 38mm
			
195547-8	195546-0	195545-2	195545-2
Ø 32mm			
			
VC2012L VC2512L VC3011L			
Ø 38mm	Ø 24mm	Ø 24mm	J22
			
P-70421	P-81745	P-81745	192349-3
Ø 32mm			
			
VC3012L VC4210LX			
Ø 38mm	Ø 24mm	Ø 24mm	J22
			
W107418688	P-70378	P-70378	192349-3

Accesorios para DRC200



Descripción	Unds.	Código	EAN	P.V.P. (€)
Cubierta de cepillo	1	SH00000314	-	40,00



Descripción	Unds.	Código	EAN	P.V.P. (€)
Cepillo recogedor	1	SH00000313	-	81,50



Descripción	Unds.	Código	EAN	P.V.P. (€)
Cinta de marcaje 15m	1	SH00000231	0088381475877	58,00



Descripción	Unds.	Código	EAN	P.V.P. (€)
Cepillo lateral	2	SH00000065	0088381479158	45,00



Descripción	Unds.	Código	EAN	P.V.P. (€)
Filtro de polvo	1	SH00000213	0088381479189	80,00

Accesorios para sopladores

Set flexible



Modelo	Unds.	Código	EAN	P.V.P. (€)
UB1103	1	196643-5	0088381437325	13,75

Toberas para UB1103



123245-4



123246-2

Descripción	Unds.	Código	EAN	P.V.P. (€)
220 mm	1	123245-4	0088381451215	5,40
430 mm	1	123246-2	0088381437332	12,60

Bolsa recogepolvo



Modelo	Unds.	Código	EAN	P.V.P. (€)
UB1103	1	123241-2	0088381437103	8,10

Tobera para DUB182



Descripción	Unds.	Código	EAN	P.V.P. (€)
220 mm	1	132025-7	0088381122856	3,85
430 mm	1	134182-7	0088381156998	10,40

Niveles láser



Trípodes



Tipo	Descripción	Rosca	Unds.	Código	EAN	P.V.P. (€)
1	Tripode aluminio 1,65M máx.	5/8"	1	P-81088	0088381449564	84,00
2	Tripode aluminio 2,70M máx.	5/8"	1	P-81315	0088381451291	251,00
3	Tripode 1,58M máx.	1/4"	1	B-8539	3240890901187	49,00
4	Tripode 1800 para SK209	1/4"	1	TK0LM4001F	0088381442374	141,00
5	Tripode 2900 para SK209	1/4"	1	TK0LM5030F	0088381442381	204,00
6	Tripode aluminio 1,15m máx SK700D	1/4"	1	LE00874658	088381539876	103,00



Receptores



TK0LDG301G



LE00796587



LE00784968



LE00796588



LE00837085



LE00837096



LE00855702

Descripción	Unds.	Modelo	Código	EAN	P.V.P. (€)
Receptor (Incluye soporte)	1	SK209	TK0LDG301G	0088381488853	321,00

Receptor (Incluye soporte) LR150	1	SKR200	LE00796587	3240890394156	330,00
Soporte del receptor	1	SKR200	LE00784968	3240890394200	66,00
Mando a distancia SKR200	1	SKR200	LE00796588	3240890394163	61,00

Receptor Funciona como mando	1	SK104Z SK103PZ	LE00837085	0088381488877	167,00
Soporte receptor	1	SK700D	LE00837096	-	50,00

Receptor Incluye soporte	1	SK700D SK700GD	LE00855702	0088381535366	221,00
--------------------------	---	----------------	------------	---------------	--------

Soportes



	Descripción	Modelo	Unds.	Código	EAN	P.V.P. (€)
1	Soporte pared	SK105D SK105DG SK106D SK106DG SK700D SK700GD	1	LE00785637	3240890328847	122,00
2	Soporte pared	SK105D SK105DG SK106D SK106DG SK700D SK700GD	1	LE00929104	-	78,00
3	Soporte simple pared	SK105D SK105DG SK106D SK106DG, SK102 SK103P SK104	1	LE00870131	0088381528726	31,00
4	Soporte magnético pared	SK105D SK105DG SK106D SK106DG SK102 SK103P SK104	1	LE00870134	0088381528733	43,00
5	Soporte para pared	SK105D SK105DG SK106D SK106DG SK102 SK103P SK104	1	LE00870137	0088381528757	72,00
6	Soporte imantado	SK104Z SK103PZ	1	LE00785633	3240890347763	14,40
7	Soporte imantado	SK104Z SK103PZ	1	LE00789389	0088381488860	42,00
8	Soporte pared	SKR200Z	1	LE00791661	3240890394170	97,00

Escala de aluminio



Longitud	Unidades	Código	EAN	P.V.P. (€)
1,2 - 4,0 m	1	P-81309	0088381451178	72,00

Tarjetas magnéticas

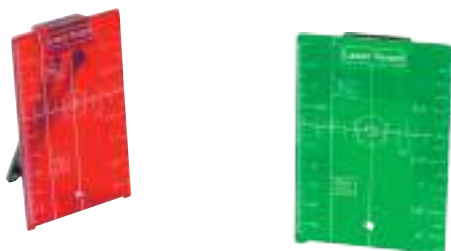

Descripción	Unds.	Código	EAN	P.V.P. (€)
Tarjeta magnética roja	1	LE00785638	3240890328830	16,75
Tarjeta magnética verde	1	LE00823195	-	23,00

Bolsas de transporte



LE00864505

Descripción	Modelo	Unds.	Código	EAN	P.V.P. (€)
Bolsa funda	SK104Z SK103PZ	1	LE00822220	-	29,00
Bolsa funda	SK105D SK105GD SK106D SK106GD	1	LE00864505	-	36,00
Bolsa funda	SK700D SK700GD	1	LE00929103	-	43,00

Gafas para mejorar la visión del láser



Descripción	Unds.	Código	EAN	P.V.P. (€)
Gafas para láser Rojo (1)	1	LE00834534	-	18,55
Gafas para láser Verde (2)	1	LE00772796	-	24,00
Gafas para láser Verde (1)	1	TK02100200	-	18,55

Cables USB



Permite usar una batería LXT de 18V cuando se usa con el adaptador para USB ADP05 (se vende por separado).

Descripción	Modelo	Unds.	Código	EAN	P.V.P. (€)
Cable USB	SK209	1	199010-3	88381519663	12,90
Cable usb	SK105 SK106	1	199178-5	0088381528238	10,30



Roedoras, cizallas y punzonadora



Capacidad en corte circular JN1601 y JN3201

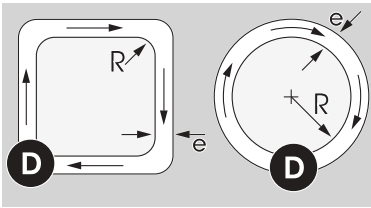

D	21 mm.	JN1601
e	5 mm.	
R	50 mm.	
D	42 mm.	JN3201
e	8 mm.	
R	128 mm.	

JS8000



Descripción	Unds.	Código	EAN	P.V.P (€)
Cabezal completo	1	125354-5	3240890285218	116,00
Cuchilla central	1	725129-8	0088381341455	68,00
Cuchilla lateral	1	725130-3	0088381341448	58,00

Troqueles



Modelo	Unds.	Código	EAN	P.V.P (€)
JN1601 DJN161	1	A-83951	0088381146630	26,00
JN3200 JN3201	1	792728-1	0088381103602	27,00

Cuchilla central



Modelo	Unds.	Código	EAN	P.V.P (€)
JS1601	1	792534-4	0088381105477	59,00
JS1000	1	792537-8	0088381105484	76,00

Juego de cuchillas



Modelo	Unds.	Código	EAN	P.V.P (€)
JS1602	1	191383-0	008838111874	29,00
JS1601	1	792533-6	0088381105453	45,00
JS1000	1	792536-0	0088381105460	45,00
JS3200 JS3201	1	792287-5	0088381103589	32,00

Matrices



Modelo	Unds.	Código	EAN	P.V.P (€)
JN1601 DJN161	1	A-15051	0088381130219	22,00
JN3200 JN3201	1	792292-2	0088381103619	26,00

Juego de galgas



Modelo	Unds.	Código	EAN	P.V.P (€)
JS1601	1	762013-6	0088381102162	3,85
JS3200 JS3201	1	762007-1	0088381102155	4,35

Llaves allen

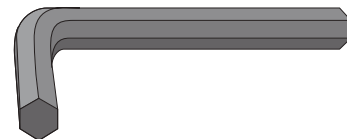

Modelo	Unds.	Código	EAN	P.V.P (€)
JS1601 JS1602 JS1000 JN3201	1	783201-2	0088381101288	1,05
JN1601	1	783208-8	0088381152624	1,05
JS3200 JS3201	1	783202-0	0088381102667	1,05

Llaves para roedoras



Modelo	Unds.	Código	EAN	P.V.P (€)
JN1601	1	781028-4	0088381152600	3,00
JN3200 JN3201	1	781019-5	0088381102452	3,10

Arandela suplementaria

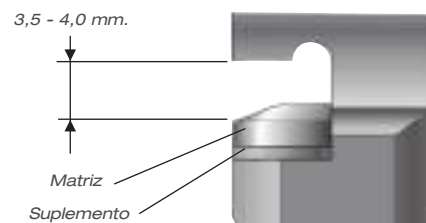

Modelo	Unds.	Código	EAN	P.V.P (€)
JN3200 JN3201	1	341796-7	0088381155298	1,05



Accesorios para DPP200

Base



Descripción	Unds.	Código	EAN	P.V.P (€)
Base	1	SC03801080	-	88,00

Topes deslizante



Descripción (mm)	Unds.	Código	EAN	P.V.P (€)
Tope deslizante	1	SC03300790	-	80,00

Accesorios para DPP200

Punzones redondos



Descripción (mm)	Unds.	Código	EAN	P.V.P (€)
Punzón 6	1	SC05340040	-	108,00
Punzón 6,5	1	SC05340050	-	108,00
Punzón 8	1	SC05340060	-	108,00
Punzón 8,5	1	SC05340070	-	108,00
Punzón 10	1	SC05340080	-	108,00
Punzón 11	1	SC05340090	-	108,00
Punzón 12	1	SC05340100	-	108,00
Punzón 13	1	SC05340110	-	108,00
Punzón 14	1	SC05340120	-	108,00
Punzón 15	1	SC05340130	-	108,00
Punzón 16	1	SC05340140	-	108,00
Punzón 18	1	SC05340150	-	108,00
Punzón 20	1	SC05340160	-	108,00

Topes redondos



Descripción (mm)	Unds.	Código	EAN	P.V.P (€)
Tope redondo SB-6	1	SC00000203	-	108,00
Tope redondo SB-6,5	1	SC00000205	-	108,00
Tope redondo SB-8,5	1	SC00000207	-	108,00
Tope redondo SB-8,5	1	SC00000209	-	108,00
Tope redondo SB-10	1	SC00000211	-	108,00
Tope redondo SB-11	1	SC00000213	-	108,00
Tope redondo SB-12	1	SC00000215	-	108,00
Tope redondo SB-13	1	SC00000217	-	108,00
Tope redondo SB-14	1	SC00000219	-	108,00
Tope redondo SB-15	1	SC00000221	-	108,00
Tope redondo SB-16	1	SC05332710	-	108,00
Tope redondo SB-18	1	SC00000223	-	108,00
Tope redondo SB-20	1	SC05352510	-	108,00

Punzones estadio



Descripción (mm)	Unds.	Código	EAN	P.V.P (€)
Punzón 6,5x10	1	SC05340200	-	149,00
Punzón 6,5x13	1	SC05340210	-	149,00
Punzón 8,5x13	1	SC05340220	-	149,00
Punzón 8,5x17	1	SC05340230	-	149,00
Punzón 9x13,5	1	SC05340240	-	149,00
Punzón 9x18	1	SC05340250	-	149,00
Punzón 10x15	1	SC05340260	-	149,00
Punzón 10x20	1	SC05340270	-	149,00
Punzón 11x16,5	1	SC05340280	-	149,00
Punzón 12x18	1	SC05340290	-	149,00
Punzón 13x19,5	1	SC05340300	-	149,00
Punzón 14x21	1	SC05340310	-	149,00

Topes estadio



Descripción (mm)	Unds.	Código	EAN	P.V.P (€)
Tope estadio 6,5x10	1	SC00000244	-	108,00
Tope estadio 6,5x13	1	SC00000246	-	108,00
Tope estadio 8,5x13	1	SC00000248	-	108,00
Tope estadio 8,5x17	1	SC00000250	-	108,00
Tope estadio 9x13,5	1	SC00000252	-	108,00
Tope estadio 9x18	1	SC00000254	-	108,00
Tope estadio 10x15	1	SC00000256	-	108,00
Tope estadio 10x20	1	SC00000258	-	108,00
Tope estadio 11x16,5	1	SC00000260	-	108,00
Tope estadio 12x18	1	SC00000262	-	108,00
Tope estadio 13x19,5	1	SC00000264	-	108,00
Tope estadio 14x21	1	SC00000266	-	108,00

Jardín



XGT
40V LI-ION
max

Sierra de cadena a batería UC002

BL
MOTOR

Alta eficiencia.

Motor BL sin escobillas de rotor exterior con sistema de accionamiento directo, que proporciona gran eficiencia de potencia.

Volumen de trabajo

unos **160** cortes

- Madera de cedro: 100 x 100 mm.
- Barra de guía 350mm.
- Sierra de cadena 90PX.
- Batería BL4040.



Peso **2,6** Kg

Velocidad de cadena

24,8 m/s

Anilla en forma de "D"
 Punto de fijación de la cuerda.



Tuerca anticaída
 para evitar su pérdida



Velocidad variable
 controlada mediante gatillo



Tapa de depósito de gran tamaño que permite un fácil rellenado de aceite.

Gran potencia, comparable a una motosierra de 30 c.c.

WG
WET GUARD
IPX4

Alta resistencia al agua, permite al operador trabajar con la herramienta incluso mojada.



Balance excelente
Herramienta muy equilibrada







Tornillo tensor



Lubricación automática de cadena

Barras y cadenas para sierras de cadena

		BARRAS					CADENAS				
		Características	Unds.	Código	EAN	P.V.P. (€)	Características	Unds.	Código	EAN	P.V.P. (€)
DUC122		11,5 cm 1/4"	1	158476-6	0088381354660	21,00	1/4" 25AP 42 eslabones	1	791284-8	0088381141741	14,75
DUC254 DUC256		25 cm 3/8" b.p.	1	161846-0	0088381540216	14,40	3/8" b.p. 0,50	1	199075-5	0088381527767	12,95
DUC254C DUC256C		25 cm 1/4"	1	168395-8	0088381200097	55,00	1/4" 25AP 60 eslabones	1	512466760	-	18,00
DUC252		25 cm (10") 3/8" - b.p.	1	168408-5	0088381197571	11,70	3/8" b.p. - 0,50 91VG 40 eslabones	1	511492740	4002829806609	13,40
DUC306		30 cm (12") 3/8" - b.p.	1	165245-8	-	13,90	3/8" b.p. - 0,50 91PX 46 eslabones	1	196740-7	-	18,55
DUC355		35 cm (14") 3/8" - b.p.	1	165441A8	-	22,00	3/8" b.p. - 0,50 91VG 52 eslabones	1	511492752	4002829806883	13,65
UC4041A		40 cm (16") 3/8" - b.p.	1	165247-4	0088381358569	22,00	3/8" b.p. - 0,50 90SG 56 eslabones	1	511291756	4002829845172	14,15
UC3550A		35 cm (14") 3/8" - b.p.	1	165441A8	-	22,00	3/8" b.p. - 0,50 91VG 52 eslabones	1	511492752	4002829806883	13,65
UC4050A ES2141KX		40 cm (16") 3/8" - b.p.	1	165247-4	0088381358569	22,00	3/8" b.p. - 0,50 91VG 56 eslabones	1	511492756	4002829807125	14,15



Fundas de espada para sierras de cadena

Fundas de espada					
Modelo	Características	Unds.	Código	EAN	P.V.P. (€)
DUC122	Fundas de espada	-	199067-4 R	-	3,00
DUC254 DUC256		1	199067-4 R	-	3,00
DUC254C DUC256C		1	199067-4 R	-	3,00
DUC252		1	452093-7	-	1,90
DUC306		1	419288-5	-	*
DUC355		1	952010640	-	4,90
UC4041A		1	419242-9 R	-	2,80
UC3550A		1	952010640	4002829615454	4,90
UC4050A ES2141KX		1	952010640	4002829615454	4,90



* Consultar P.V.P.

Palas para ramaje



Modelo	Unds.	Código	EAN	P.V.P. (€)
DUH523	1	195050-9	0088381358064	37,00
EH7500S	1	195321-4	0088381403375	22,00
UH201	1	198401-5	0088381483728	9,10
UH5570 UH5580 UH6570 UH6580	1	194681-1	0088381354349	23,00
UH004G UH006G	1	191R51-3	0088381583565	45,00
UH005G UH007G	1	191R52-1	0088381583572	73,00
DUN461	1	191T43-4	0088381583893	15,60
DUH754S UH014G	1	191D34-9	0088381559478	36,00

Sistema de antidesconexión eléctrica



158024-1

194678-0

Para	Unds.	Código	EAN	P.V.P. (€)
Sierras de cadena	1	158024-1	0088381122955	1,60
Cortasetos	1	194678-0	0088381352079	2,05

Calibrador de cadena



Descripción	Unds.	Código	EAN	P.V.P. (€)
Calibrador	1	953100090	4002829111956	6,20

Llaves de bujía



941713001

Set de calibrado / afilado



Incluye	Unds.	Código	EAN	P.V.P. (€)
Lima redonda 4mm (x2), soporte, mango (x2) y calibre de profundidad.	1	D-72154	0088381568340	23,00
Lima redonda 4,5mm (x2), soporte, mango (x2) y calibre de profundidad.	1	D-72160	0088381568357	23,00

Lima plana y mango de lima



Mango

Lima plana

Descripción	Unds.	Código	EAN	P.V.P. (€)
Mango de lima	1	953004010	4002829111727	2,30
Lima plana	1	953003060	4002829111659	6,45

Lima redonda



Ø de lima	Tipo de cadena	Unds.	Código	EAN	P.V.P. (€)
Mango de lima		1	953004010	4002829111727	2,30
4,0 mm - 5/32"	91VG, 90SG	1	953003090	4002829111703	2,15
4,8 mm - 3/16"	95VP, 21BP	1	953003070	4002829111666	2,15
5,2 mm - 3/64"	73LP, 73DP0	1	953003110	4002829477212	2,15
5,5 mm - 7/32"	73LP, 73DP	1	953003040	4002829111628	2,15

Conjunto porta-lima



Ø de lima	Tipo de cadena	Unds.	Código	EAN	P.V.P. (€)
4,0 mm - 5/32"	91VG, 90SG	1	953030010	4002829111871	14,95
4,8 mm - 3/16"	95VP, 21BP	1	197712-5		7,45
5,5 mm - 7/32"	73LP, 73DP	1	953009000	4002829111857	13,90

Modelo	Ø (mm)	Unds.	Código	EAN	P.V.P. (€)
DCS232T DCS232TC DCS3410TH	13/16 mm.	1	941716132	4002829824498	2,85
Resto de modelos	13/19 mm	1	941719133	4002829824511	2,85
ELECTROSIE-RRAS	13 mm.	1	941713001	4002829172780	2,30

Sopladores

Boquillas de salida



451753-8

183P98-9

183P97-1

455915-0

455634-8

197724-8

454896-5

166094-6

183P98-9

452123-4

191L96-5

191J13-3

Modelo	Detalle	Unds.	Código	EAN	P.V.P. (€)
BHX2501	Boquilla plana	1	451753-8	0088381411332	4,10
DUB184	Boquilla plana	1	183P98-9	0088381580373	10,85
	Extensión boquilla	1	183P97-1	0088381497152	10,60
	Tubo adaptador	1	191L14-3	-	6,20
	Boquilla de salida larga	1	191B21-6	-	*
DUB362	Boquilla plana	1	183P98-9	0088381580373	10,85
	Extensión boquilla	1	183P97-1	0088381497152	10,60
	Boquilla de salida larga	1	183R02-0	0088381585507	7,10
		1	191J13-3	0088381560887	9,70
	Arnés	1	166094-6	0088381494977	3,75
DUB363	Boquilla de salida larga	1	127425-4	0088381576352	9,80
		1	127501-4	-	8,25
		1	127502-2	0088381576369	16,90
DUB361		1	452123-4	0088381366373	12,35
UB001	Boquilla plana	1	191L96-5	-	10,65
		1	183P98-9	0088381580373	10,85
	Arnés	1	166094-6	0088381494977	3,75
EB7660TH	Boquilla plana	1	455634-8	-	13,15
EB5300TH	Tubo recto 90mm	1	197724-8	0088381472760	15,45
PB7650	Tubo cónico	1	454896-5	0088381453455	7,70

* consultar .

Kit de aspiración BHX2501



Modelo	Descripción	Unds.	Código	EAN	P.V.P. (€)
BHX2501	kit de aspiración	1	197235-3	0088381474924	66,00

Accesorio para limpieza de canalones



Modelo	Descripción	Unds.	Código	EAN	P.V.P. (€)
DUB362	Kit de aspiración	1	191B03-8	0088381560870	86,00

Kit de aspiración DUB363



Modelo	Descripción	Unds.	Código	EAN	P.V.P. (€)
DUB363	Kit de aspiración	1	191E19-1	0088381558754	69,00

Motores multifunción a batería.



XGT

**Una herramienta,
múltiples aplicaciones...**



LXT

Litio-ion **EXTREMA** TECNOLOGIA

Ahora también con batería XGT

Accesorios para multifunción UX001G / DUX60 / DUX18



9 en 1



Descripción	Unds.	Código	EAN	P.V.P. (€)
Sierra de cadena	1	191T38-7	0088381581271	180,00



196345-3	198068-9	197750-7		
Cortasetos de ángulo ajustable	1	196345-3	0088381424905	279,00
Cortasetos para suelo	1	198068-9	0088381473620	332,00
Cortasetos recto	1	197750-7	0088381469258	228,00



Desbrozador	1	195663-6	0088381376853	112,00
-------------	---	----------	---------------	--------



Cepillo barredor	1	199318-5	0088381533942	544,00
------------------	---	----------	---------------	--------



Recortabordes	1	195566-4	0088381397650	84,00
---------------	---	----------	---------------	-------



Cultivador	1	195717-9	0088381398060	268,00
------------	---	----------	---------------	--------



Rodillo de limpieza	1	199339-7	0088381534130	570,00
---------------------	---	----------	---------------	--------



Soplador	1	191P72-3	0088381580212	159,00
Boquilla de salida	1	191C15-7	0088381558747	8,75



Descripción	Unds.	Código	EAN	P.V.P. (€)
Prolongador	1	191E27-2	0088381558600	118,00

Novedad



191M75-9	191M56-3			
Corte rotativo	1	191M75-9	-	464,00
Corte rotativo + barra	1	191M56-3	0088381572132	510,00

Desbrozadoras



Discos para desbrozadoras

Tipo	Modelo	Características	Unds.	Código	EAN	P.V.P. (€)
	EBH341U EM2600U EM2651UH EM4350UH EM4351UH	270 x 25,4	1	199874-5		38,00
		255 x 25,4	1	195299-1	0088381364935	21,95
		300 x 25,4	1	385224150	4002829752159	25,00
		230 x 25,4	1	DA00000169		15,45
		230 x 25,4	1	B-14118	0088381361064	11,35
		255 x 25,4	1	B-14124	0088381361071	11,85
			230 x 25,4	1	B-14130	0088381361088
255 x 25,4			1	B-14146	0088381361095	13,40
		225 x 25,4	1	199872-9		25,00
		230 x 25,4	1	B-14152	0088381361101	13,40
		255 x 25,4	1	B-14168	0088381361118	14,95





Adaptadores de cabezal

Tipo de cabezal	Descripción / Medida	Unds.	Código	EAN	P.V.P. (€)
	Cabezal manual Casquillo LH 8x1.25 Casquillo LH 10x1.00 Espárrago LM8x1.25 / 0x1.25"	1	385224250	4002829760161	8,75
	Cabezal T&G medium Casquillo LH 8x1.25 Casquillo LH 10x1.00 Espárrago LM8x1.25 / 10x1.25"	1	381224230	4002829760147	5,65
	Cabezal T&G large Casquillo LH 8x1.25 Casquillo LH 10x1.00 Casquillo LH12x1.50 Casquillo LH 12x1.75 Espárrago LM8x1.25 / 10x1.25"	1	382224310	4002829760154	7,70
	Cabezal T&G Small Casquillo LH 10x1,25	1	UA-1048	-	3,85

* Es necesario utilizar adaptador.



Tabla de compatibilidad de modelos

		Fijo 	Manual 	T&G small 	T&G medium 	T&G large 
EM2600U	M10x1.25 LM	✓	✓	◇	✓	✓
EM2651UH	M10x1.25 LM	✓	✓	◇	✓	✓
EM3400U	M10x1.25 LM	✓	✓	◇	✓	✓
EM4350UH	M10x1.25 LM	✓	✓	◇	✓	✓
EM4351UH	M10x1.25 LM	✓	✓	◇	✓	✓
EBH341U	M10x1.25 LM	✓	✓	◇	✓	✓
BBC4500	M10x1.00 LM	✓	*	-	*	*
BBC5700	M10x1.00 LM	✓	*	-	*	*
DUR190	M10x1.25 LM	✓	✓	◇	✓	✓
DUR365	M10x1.25 LM	✓	✓	◇	✓	✓
DUR368	M10x1.25 LM	✓	✓	◇	✓	✓
DUR369	M10x1.25 LM	✓	✓	◇	✓	✓
DUX60	M10x1.25 LM	✓	✓	◇	✓	✓
UR101C	M10x1.25 LM	✓	✓	◇	✓	✓
UR201C	M10x1.25 LM	✓	✓	◇	✓	✓

- No compatible. ✓ Compatible. * Es necesario utilizar adaptador. ◇ Válido con adaptador UA-1048.









Cabezales de Nylon

- Los cabezales Tap&Go son de carga fácil. No es necesario desmontar el cabezal para cargar el hilo.
- Cinco nuevos cabezales de Nylon para cubrir las necesidades de todos nuestros modelos de desbrozadoras.
- Gama simplificada para facilitar la elección de nuestros clientes.





Tipo cabezal	Rosca	Capacidad	Recomendado	Descripción	Unds.	Código	EAN	P.V.P. (€)	
	Cabezal nylon	-	-	ET40	-	1	DA00000002	0088381374033	8,00
	Cabezal nylon	-	6m	DUR181	Hilo de nylon de corte redondo	1	195858-1	0088381400176	7,00
	Cabezal nylon T&G	Rosca M8 x 125RH	4m		Hilo silencioso de 2,0 mm	1	191D92-5	0088381559300	17,50
	Cabezal nylon T&G	Rosca M8 x 125LH	4m		Hilo silencioso de 2,0 mm	1	191D91-7	0088381559294	17,50
	Cabezal nylon	Rosca M8 x 125LH	-		DUR182 DUR187 DUR189	Hilo silencioso de 2,0 mm	1	123235-7	0088381498098
	Cabezal fijo	Universal	20cm	-	Hilo silencioso de 2,7 mm	1	384224270	4002829757741	23,00
	Cabezal manual	M10 x 1.25LH (izq.)	5m	Todos los modelos a batería	Hilo silencioso de 2,4 mm	1	385224240	4002829757734	17,25
	T&G small	Rosca M8 x 1.25RH (dcha.)	3,5m	DUX60 (con adaptador UA-1048) Todos los modelos a batería.	Hilo silencioso de 2,0 mm	1	680224200	4002829757703	14,15
	T&G medium	M10 x 1.25LH (izq.)	4,5m	EM2600U EM2651UH EM3400U EBH341U DUX60 Todos los modelos a batería	Hilo silencioso de 2,4 mm	1	381224240	4002829757710	17,25
	T&G large	M10 x 1.25LH (izq.)	4,5m	EM4350UH EM4351UH BBC4500* BBC5700* Todos los modelos a batería	Hilo silencioso de 2,7 mm	1	382224300	4002829757727	19,55

Hylos de nylon





Tipo	Descripción	Ø (mm)	Longitud (m)	Unds.	Código	EAN	P.V.P. (€)
Redondo	 <ul style="list-style-type: none"> Hilo de nylon redondo 1,65X15 metros. Especial para DUR181 	1,65	15	1	196148-5	0088381411523	4,85
Redondo	 <ul style="list-style-type: none"> Desarrollado para el usuario más exigente en el uso privado. Indicada para desbrozadoras de baja cilindrada. 	2,4	5	1	B-01971	0088381120494	2,30
		3,0	4	1	B-07375	0088381349291	3,10
Round Trim	 <ul style="list-style-type: none"> Desarrollado para el usuario más exigente en el uso privado. Dos colores. Indicado para desbrozadoras de baja cilindrada. El hilo redondo ofrece mayor resistencia al aire y al impacto. 	1,3	15	1	369224807	-	2,15
		1,6	15	1	369224808	-	2,45
		2,0	15	1	369224790	4002829756614	2,60
		2,0	126	1	369224791	4002829756621	10,80
Round Trim PLUS	 <ul style="list-style-type: none"> Desarrollado para el uso privado y semi-profesional. Incrementamos la resistencia al desgaste y el punto de fusión. Indicado para máquinas de mediana cilindrada. 	2,4	15	1	369224792	4002829756638	3,35
			87	1	369224793	4002829756645	11,05
			262	1	369224794	4002829756652	29,00
		3,0	15	1	369224809	-	4,10
			56	1	369224811	-	11,05
			168	1	369224815	-	29,00
		3,3	15	1	369224810	-	4,65
			46	1	369224812	-	11,05
			139	1	369224816	-	29,00
Square Trim PLUS	 <ul style="list-style-type: none"> Desarrollado para el uso semi-profesional. Incrementamos la resistencia al desgaste y el punto de fusión. Disminuye la pérdida de rpm por rozamiento gracias a sus aristas. Indicado para máquinas de mediana cilindrada. 	2,4	15	1	369224795	-	3,85
			69	1	369224796	-	11,05
			206	1	369224797	-	29,00
		3,0	15	1	369224819	-	4,90
			44	1	369224821	-	11,05
			132	1	369224825	-	29,00
		3,3	15	1	369224820	-	4,90
			36	1	369224822	-	11,05
			109	1	369224826	-	29,00
		3,5	32	1	369224823	-	11,05
			96	1	369224827	-	29,00
		4,0	25	1	369224824	-	11,05
75	1		369224828	-	29,00		
Round Trim PRO	 <ul style="list-style-type: none"> Desarrollado para el uso profesional. Alta resistencia al calor. Para los trabajos más exigentes. Indicado para desbrozadoras de alta cilindrada. Combina dos capas de material con diferentes durezas. 	3,0	15	1	369224798	4002829756669	4,90
			56	1	369224799	4002829756676	13,15
			168	1	369224800	-	33,00
			279	1	369224801	4002829756690	52,00
Square Trim PRO	 <ul style="list-style-type: none"> Desarrollado para el uso profesional. Alta resistencia al calor. Para los trabajos más exigentes. Indicado para desbrozadoras de alta cilindrada. Disminuye la pérdida de rpm por rozamiento gracias a sus aristas. Combina dos capas de material con diferentes durezas. 	3,0	15	1	369224802	-	5,40
			44	1	369224803	4002829756799	13,15
			132	1	369224804	-	34,00
			219	1	369224805	-	52,00

Hylos de nylon silenciosos

Tipo	Descripción	Ø (mm)	Longitud (m)	Unds.	Código	EAN	P.V.P. (€)
Linea Cuatro Hojas 	<ul style="list-style-type: none"> Hilo de nylon helicoidal. Forma de cuatro hojas redondeadas que disminuye el nivel de ruido. Gracias a su forma que tiene menos resistencia al aire que la línea redonda de nylon, aporta mayor cantidad de trabajo. En comparación a otros hilos, el tiempo de trabajo aumenta un 20% con una sola carga de batería. Indicado para máquinas a batería. 	2,0	15	1	E-01769	0088381555487	3,10
		2,0	30	1	E-01775	0088381555494	5,80
		2,0	310	1	E-01781	0088381555500	42,00
Linea Cuatro Hojas 		2,4	15	1	E-01797	0088381555517	3,90
		2,4	30	1	E-01806	0088381555524	7,35
		2,4	225	1	E-01812	0088381555531	44,00
Linea Cuatro Hojas 		2,7	15	1	E-01828	0088381555548	4,45
		2,7	30	1	E-01834	0088381555555	8,15
		2,7	180	1	E-01840	0088381555562	42,00



Cabezal Policut

Tipo cabezal	Rosca	Modelo	Descripción	Unds.	Código	EAN	P.V.P. (€)	
	Policut	Universal	"Recomendado para modelos a batería"	Cabezal de cuchillas flotantes recambiables	1	197188-6	0088381458214	28,00
	Juego cuchillas Policut	Universal	"Recomendado para Policut"	12 cuchillas	1	197189-4	0088381458276	22,00
	Policut curvo	Universal	"Recomendado para modelos a batería"	Cabezal de cuchillas flotantes recambiables	1	198383-1	0088381488129	26,00
	Juego cuchillas Policut	Universal	"Para policut curvo"	3 cuchillas	1	198426-9	0088381488143	13,25

Aceites

Aceite de 2T mineral



Cantidad	Unds.	Código	EAN	P.V.P. (€)
100ml	1	980008106	4002829239551	1,90
1 Litro	1	980008107	4002829000274	6,70
1 Litro con dosificador	1	980008112	4002829414477	11,35
5 Litros	1	980008118	4002829486030	31,00

Aceite de 4T HD30 Monogrado



Cantidad	Unds.	Código	EAN	P.V.P. (€)
600ml	1	980008120	4002829441336	4,10

Aceite de 4T SJ10W30 Multigrado



Cantidad	Unds.	Código	EAN	P.V.P. (€)
80ml	1	196122-3	-	2,60
100ml	1	197010-7	0088381452731	5,15

Aceite de 4T 5W30 Multigrado



Cantidad	Unds.	Código	EAN	P.V.P. (€)
1 Litro	1	980008121	4002829760475	7,70

Aceite de 2T sintético



Cantidad	Unds.	Código	EAN	P.V.P. (€)
1 Litro	1	980008103	4002829760314	11,85

Aceite de cadena Biotop (Biodegradable)



Cantidad	Unds.	Código	EAN	P.V.P. (€)
1 Litro	1	980008210	4002829155028	5,95
5 Litros	1	980008211	4002829155035	29,00

Aceite de cadena



Cantidad	Unds.	Código	EAN	P.V.P. (€)
1 Litro	1	988002256	4002829137390	4,40
5 Litros	1	988002258	4002829137406	18,55

Líquido limpieza cadena



Cantidad	Unds.	Código	EAN	P.V.P. (€)
500ml.	1	980008125	4002829441343	9,25

Correa para desbrozadoras



- Arnés profesional, muy ergonómico, perfecto para las largas jornadas de trabajo.
- Reduce la tensión en la zona lumbar y en los hombros.
- Mejora la maniobrabilidad.
- Amplio protector lumbar que ayuda a que no se cargue la cadera.
- Arnés totalmente ajustable.



Modelos	Unds.	Código	EAN	P.V.P. (€)
Todos los modelos	1	196335-6	0088381423694	51,00
	1	196129-9	0088381442459	51,00

Modelos	Unds.	Código	EAN	P.V.P. (€)
Arnes para desbrozadoras en PDC1200	1	191E43-4	0088381556859	13,55



Modelos	Unds.	Código	EAN	P.V.P. (€)
Todos los modelos	1	122907-1	0088381426909	25,00

Modelos	Unds.	Código	EAN	P.V.P. (€)
Válido para desbrozadoras y batería de mochila PDC01.	1	197243-4	0088381454285	5,65

Protección

Viseras protectoras

Protector de oído



P-47363

P-47357

Descripción	Unds.	Código	EAN	P.V.P. (€)
Visera protectora transparente con goma	1	P-47363	0088381977791	10,30
Visera protectora metálica con goma	1	P-47357	0088381977784	8,50

Descripción	Unds.	Código	EAN	P.V.P. (€)
Protector de oído	1	988000040	4002829215838	27,00

Accesorios para ahoyadora DDG460

Brocas para ahoyadora DDG460



Ø (mm)	Largo (mm)	Unds.	Código	EAN	P.V.P. (€)
100	800	1	E-07294	0088381572439	100,00
150	800	1	E-07303	0088381572446	117,00
200	800	1	E-07319	0088381572453	138,00

Prolongador



Largo (mm)	Unds.	Código	EAN	P.V.P. (€)
540	1	E-07325	0088381572460	31,00

Cuchilla



Ø (mm)	Unds.	Código	EAN	P.V.P. (€)
100	1	E-07630	0088381574518	11,25
150	1	E-07646	0088381574525	12,35
200	1	E-07652	0088381574532	14,45

Bulón para barrena



Descripción	Unds.	Código	EAN	P.V.P. (€)
Bulón	1	E-07331	0088381572477	3,20

Bulón para barrena



Descripción	Unds.	Código	EAN	P.V.P. (€)
Adaptadores	1	327685-0		36,00
	1	327684-2	0088381580175	31,00
	1	327687-6	0088381574471	27,00

Set mango ddg460



Descripción	Unds.	Código	EAN	P.V.P. (€)
Mango	1	191P11-3	0088381576994	143,00



Brocas para suelo 3/4"

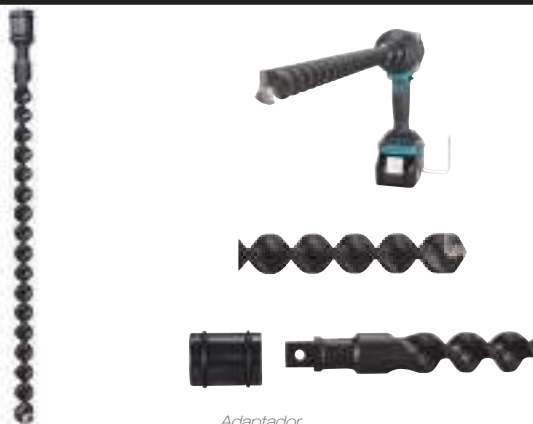

Broca

Adaptador

Modelo	Descripción	Unds.	Código	EAN	P.V.P. (€)
DTW1001	Ø 20mm / 600 mm	1	B-54346	0088381477468	185,00
	Ø 25mm / 600 mm	1	B-54352	0088381477475	190,00
	Ø 30mm / 600 mm	1	B-54368	0088381477482	214,00
	Ø 35mm / 600 mm	1	B-54374	0088381477499	253,00
	Adaptador 3/4"	1	B-54380	0088381477505	47,00



Accesorios para DUC122 y UC120D



Modelo	Descripción	Unds.	Código	EAN	P.V.P. (€)
DUC122	Extensión	1	195595-7	0088381398510	190,00
UC120D	Extensión 1,3 - 2,2 m.	1	192755-2	0088381146142	194,00



Modelo	Descripción	Unds.	Código	EAN	P.V.P. (€)
DUC122	Lima	1	953003090	4002829111703	2,15



Modelo	Descripción	Unds.	Código	EAN	P.V.P. (€)
DUC122	Aceite	1	199897-3	0088381582131	4,10

Destornillador de regulación



Descripción	Unds.	Código	EAN	P.V.P. (€)
Atornillador Philips n°2	1	783002-8	0088381102650	1,80
Regulación de carburador	1	783012-5	0088381417839	0,55



Cuchillas y accesorios para tijeras de poda



197367-6



197366-8

Modelo	Descripción	Unds.	Código	EAN	P.V.P. (€)
DUP361	Cuchilla fija	1	197367-6	0088381465373	44,00
	Cuchilla móvil	1	197366-8	0088381463720	50,00
DUP362	Cuchilla fija	1	199169-6	0088381526425	123,00
	Cuchilla móvil	1	199168-8	0088381526418	98,00



A-86664



B-05016

Modelo	Descripción	Unds.	Código	EAN	P.V.P. (€)
4604D	Cuchilla fija	1	A-86664	0088381150965	46,00
	Cuchilla móvil	1	B-05016	-	32,00

Arnés para tijera de poda DUP361 / 362



Descripción	Unds.	Código	EAN	P.V.P. (€)
Arnés para DUP361 y DUP362	1	161377-9	0088381473750	35,00

Lima de diamante y aceite



Modelo	Descripción	Unds.	Código	EAN	P.V.P. (€)
4604D DUP361 DUP362	Lima de diamante	1	794530-8	0088381116893	12,35
	Aceite	1	182470-6	0088381498135	1,40



Accesorios para cortasetos y cortahierbas

TIPO A Forma óptima de la cuchilla para un corte suave.



- Cuchillas afiladas:
- Cuchilla superior... curvada hacia abajo.
- Cuchilla inferior... curvada hacia arriba.

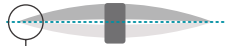

- Punto de contacto de ambas cuchillas.

- Las ramas se atrapan fácilmente y se sostienen firmemente entre las cuchillas.

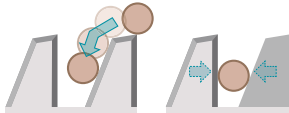

TIPO B Hoja libre de manchas

- Niquelado no electrolizado
- Revestimiento de superficie uniforme y fuertemente adherido que presenta una superficie de alta resistencia a la abrasión para un revestimiento de larga duración.



Savia en la hoja
(después de 10h de trabajo)



Sin manchas en la hoja



Nuestros modelos actuales

Peine cortasetos



Longitud (mm)	Modelo	Tipo	Unds.	Código	EAN	P.V.P. (€)
200	UH201D	B	1	198408-1	0088381483766	30,00
520	DUH523	B	1	195769-0	0088381398374	92,00
500	DUH501	A	1	199098-3	0088381531795	103,00
600	DUH601 UH004G	A	1	199099-1	0088381531818	103,00
650	DUH651	B	1	196688-3	0088381437547	134,00
750	DUH751 DUH754S	A	1	191D39-9	0088381559492	160,00
500	DUN500W	A	1	191C14-9	0088381559423	129,00
750	DUH751 UH005G	A	1	191R54-7	0088381583510	155,00
600	UH006G	B	1	191R55-5	0088381583527	155,00
750	UH007G	B	1	191R56-3	0088381583534	170,00
480	UH4861	C	1	140830-8	-	62,00
550	UH5570	C	1	194663-3	0088381354141	38,00
650	UH6570	C	1	194666-7	0088381354172	44,00
550	UH5580	C	1	194671-4	0088381360401	77,00
650	UH6580 DUH651	C	1	194673-0	0088381360418	62,00

Peines cortasetos / cortahierbas



195272-1



195176-7



191N24-2



191N23-4

Descripción	Unds.	Código	EAN	P.V.P. (€)
Peine cortasetos DUM604	1	195272-1	0088381362399	23,00
Peine cortahierbas DUM604	1	195176-7	-	49,00
Peine cortasetos DUM111	1	191N24-2	0088381580052	22,00
Peine cortahierbas DUM111	1	191N23-4	0088381580045	30,00

Protectores de peine



Descripción	Unds.	Código	EAN	P.V.P. (€)
Protector de peine cortasetos	1	458342-0	-	4,00
Protector de peine cortahierbas	1	452055-5	0088381371407	2,40

Mango extensible



Descripción	Unds.	Código	EAN	P.V.P. (€)
Mango extensible DUM604	1	195187-2	0088381362412	58,00
Mango extensible DUM111	1	198516-8	0088381490238	60,00

Set de varillas para HL360D



Descripción	Unds.	Código	EAN	P.V.P. (€)
Set de varillas	8	UL23-08/C	-	48,00

Hidrolimpiadoras



Pistolas



Lanza con boquilla



P-64917



197876-5



197824-4

Modelo	Material	Unds.	Código	EAN	P.V.P. (€)
HW102 HW111	Plástico	1	HW3320152	-	8,65
HW120	Metálica	1	HW41847		51,00
HW131RLW	Metálica	1	HW40925	8016287409254	48,00
HW132	Plástico	1	HW3640920	-	27,00
HW151	Metálica	1	HW41154	8016287411547	24,00
HW1200 HW1300 DHW080	Plástico	1	197842-2	0088381488990	22,00

Modelo	Tipo	Unds.	Código	EAN	P.V.P. (€)
HW102	Plana	1	HW3640640	-	3,50
HW102 HW111	Turbo	1	HW3320120	-	4,30
HW120	Plana	1	HW46221	-	26,00
HW131RLW	Plana	1	P-64901	0088381995429	38,00
HW131RLW	Turbo	1	P-64917	0088381995436	83,00
HW132	Plana	1	HW3641150	-	10,25
HW132	Turbo	1	HW3640940	-	10,55
HW151	Plana	1	HW40551	8016287405515	29,00
HW151	Turbo	1	HW40167	8016287401678	50,00
HW1200 HW1300 DHW080	Plana	1	197822-8	0088381484626	13,30
	Spray	1	197876-5	0088381496032	24,00
	Turbo	1	197824-4	0088381518383	13,75
	Turbo	1	191U88-8	0088381583855	35,00

Boquillas



HW3086

HW3640670

191U86-2

Modelo	Descripción	Unds.	Código	EAN	P.V.P. (€)
HW120	Boquilla	1	HW3086	-	16,20
HW111 HW132	Boquilla	1	HW3640670	-	2,30
HW1200 HW1300 DHW080	Boquilla abanico	1	191U86-2	0088381583848	25,00

Extensión



Manguera de alta presión



Modelo	Material	Unds.	Código	EAN	P.V.P. (€)
HW102 HW111	Plástico	1	HW3320130	-	4,30
HW1200 HW1300 DHW080	Plástico	1	197870-7	0088381484671	46,00
HW1200 HW1300	Plástico	1	198909-9	0088381497367	33,00

Modelo	Longitud	uds.	Código	EAN	P.V.P. (€)
HW102	5 m	1	HW3640630	-	10,80
HW111	5,5 m / 12 mm	1	HW3640660	-	44,00
HW120	10 m	1	HW3163270	-	160,00
HW131	15 m	1	HW2500390	-	170,00
HW132	8 m	1	HW3641570	-	59,00
HW151	10 m	1	HW3083550	-	75,00

Manguera desatascadora



Para la limpieza de tuberías.

Modelo	Longitud	Unds.	Código	EAN	P.V.P. (€)
HW102 HW111 HW132	8 m	1	P-64892	0088381995412	43,00
HW131 HW151	8 m	1	P-66503	0088381997034	48,00
HW102 HW111 HW132 HW151	10 m	1	HW41165	8016287411653	62,00
HW102 HW111 HW132 HW151	16 m	1	HW41167	8016287411677	98,00
HW1200 HW1300 DHW080	10 m	1	197837-5	0088381484657	25,00
	15 m	1	197840-6	0088381484664	31,00

Extensión de manguera de alta presión



Modelo	Longitud	Unds.	Código	EAN	P.V.P. (€)
HW102	5 m	1	HW41179	8016287411790	26,00
HW111 HW132	8 m	1	HW41181	8016287411813	70,00
HW1200 HW1300 DHW080	5 m	1	197845-6	0088381484688	28,00
	8 m	1	197847-2	0088381484695	38,00
	10 m	1	197850-3	0088381484701	45,00

Cepillos



Modelo	Descripción	Unds.	Código	EAN	P.V.P. (€)
HW102 HW111 HW132.	Cepillo para suelo mini.	1	HW41175	8016287411752	55,00
HW102 HW111 HW132 HW151	Kit de succión de agua	1	HW41163	8016287411639	56,00
HW1200 HW1300 DHW080	Kit manguera de aspiración	1	197873-1	0088381484633	35,00

Cepillos



*Es necesario adaptador HW3082750.

Modelo	Descripción	Unds.	Código	EAN	P.V.P. (€)
HW111 HW132 HW151* HW131RLW*	Triangular	1	HW3640950	-	5,95



Modelo	Descripción	Unds.	Código	EAN	P.V.P. (€)
HW102 HW111 HW132 HW151	Triangular	1	HW41185	8016287411851	18,00



*Es necesario adaptador HW3082750.

Modelo	Descripción	Unds.	Código	EAN	P.V.P. (€)
HW111 HW132 HW151* HW131RLW*	Rotativo	1	P-64858	0088381995375	21,00



*Es necesario adaptador HW3082750.

Modelo	Descripción	Unds.	Código	EAN	P.V.P. (€)
HW131RLW HW111 HW132 HW151	Para suelo sin depósito. Adaptador HW40542 incluido	1	HW41849	-	72,00



Modelo	Descripción	Unds.	Código	EAN	P.V.P. (€)
HW131RLW HW151	Rotativo	1	HW41187	8016287411875	31,00



Modelo	Descripción	Unds.	Código	EAN	P.V.P. (€)
HW1200 HW1300 DHW080	Rotativo	1	197831-7	0088381484640	16,20



Cepillos



Modelo	Descripción	Unds.	Código	EAN	P.V.P. (€)
HW1200 HW1300 DHW080	Cepillo triangular	1	197828-6	0088381489010	10,20



Modelo	Descripción	Unds.	Código	EAN	P.V.P. (€)
HW1200 HW1300 DHW080	Cepillo antisalpicadura	1	197864-2	0088381496001	23,00

Adaptadores para hidrolimpiadoras



HW3082750



P-64870



197883-8



197867-6



197853-7

Modelo	Descripción	Unds.	Código	EAN	P.V.P. (€)
HW131RLW HW151 HW120	Adaptador	1	HW3082750	-	12,60
Todos los modelos	Conector tipo Gardena	1	P-64870	0088381995399	9,80
HW1200 HW1300 DHW080	Casquillo seguridad	1	197867-6	0088381490221	16,25
HW1200 HW1300 DHW080	Conector rápido	1	197883-8	0088381496049	6,05
HW1200 HW1300 DHW080	Adaptador	1	197853-7	0088381484749	8,40

Depósitos para detergente y detergente neutro



HW3640090



P-64864



197886-2

Modelo	Descripción	Unds.	Código	EAN	P.V.P. (€)
HW102	Depósito detergente	1	HW3640090	-	3,25
Todos los modelos	Detergente neutro 1L	1	P-64864	0088381995382	17,50
	Aguja de limpieza de boquilla	1	197879-9	0088381496018	2,15
HW1200 HW1300 DHW080	Bote para detergente	1	197886-2	0088381489003	19,95

Accesorios de carretilla DCU180

Cuba, plataforma y rueda de transporte para DCU180



199008-0



199009-8

Modelo	Descripción	Unds.	Código	EAN	P.V.P. (€)
DCU180	Plataforma transporte	1	199009-8	0088381519632	209,00
	Set cubeta	1	199008-0	0088381519625	181,00
	Set ruedas auxiliares	1	191A01-6	0088381545945	136,00



NUEVA **COLECCIÓN**

Portaherramientas



Tecnologías:

STRAP/BELT SYSTEM

El sistema de correa con hebillas de liberación rápida en los extremos hace posible que pueda pasar fácilmente de un portaherramientas tipo bolsa a llevarlo en la cintura como un cinturón de herramientas ligero. Posibilidad de guardar más portaherramientas en el interior.



HEAVY-LOAD SUPPORT SYSTEM

El sistema de soporte de cargas pesadas proporciona una ayuda adicional para llevar un conjunto de herramientas, accesorios y portaherramientas súper pesados distribuyendo el peso entre la cintura y los hombros. Cómodo de llevar y reduce el cansancio durante la jornada laboral gracias a la amortiguación extragruesa de 20 mm.



TOOL LOOPS SYSTEM

El innovador sistema de alojamientos especiales para herramientas permite al usuario colocar diferentes herramientas o accesorios sin necesidad de ajustes. El material de alta calidad garantiza una gran durabilidad. La combinación de varios tamaños de estos alojamientos permite colocar fácilmente herramientas o accesorios de diferentes tamaños de la forma adecuada.



CB BACKPACK CARRYING SYSTEM

El sistema de transporte de mochila mantiene el portaherramientas en su lugar de forma segura a la espalda para tener libres totalmente las manos. Es ajustable, lo que reduce la fatiga de los hombros. Incluye un bloqueo deslizable para un ajuste rápido.



WATERPROOF BOTTOM

La base impermeable de alta calidad es una de las grandes ventajas de estos portaherramientas: rígida, resistente al desgaste e impermeable, mantiene las herramientas secas y protegidas de superficies húmedas y mojadas. La base de plástico reforzado también ayuda a mantener limpio el portaherramientas.



ANTI SLIP

El material antideslizante minimiza o incluso evita los accidentes por resbalones y caídas en el lugar de trabajo. La cinta de polipropileno de alta calidad tiene una superficie de goma que ayuda a mantener las herramientas en su lugar y proporciona protección extra que ayuda a prolongar la vida útil de los productos.



3 LAYERS

La tecnología de 3 capas es una combinación única de poliésteres y espumas que proporcionan una amortiguación y protección extra. Diseñadas para ser resistentes a la intemperie, estos paneles de polipropileno increíblemente ligeros están formados por tres capas unidas de forma segura. La característica innovadora de estos paneles está en la capacidad de colocarse dentro de cualquier espacio.





**REAL
LEATHER**

El cuero es suave por fuera y cepillado por dentro. Fuerte y resistente para una larga vida útil, pero lo suficientemente suave y flexible para una gran comodidad, al tiempo que proporciona una excelente resistencia, especialmente a los roces. Se ha elegido el cuero para la fabricación de productos que requieren de una capa más gruesa (de 1,8 a 2,0 mm), lo que garantiza la máxima calidad.



**DURABLE
RIVETING**

El remache duradero proporciona una resistencia realmente irrompible. Resistentes remaches autoperforantes de una pieza con arandelas que se utilizan en todas las zonas con alta tensión. Se utilizan arandelas para una mayor resistencia en uno o ambos lados de lugares estratégicos, hacia arriba y hacia abajo.

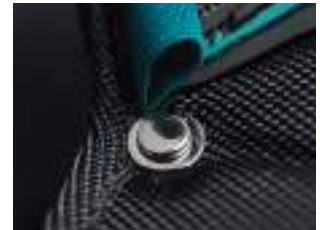

**LOOP-CLIP
SOLUTION**

La sujeción con mosquetón al cinturón es un sistema innovador gracias al cual, cada bolsa se puede sujetar de manera fácil pero segura a su cinturón. El exclusivo sistema de bloqueo protege la herramienta o el accesorio de caídas. Enganchar tus herramientas nunca ha sido tan fácil.



**ELASTIC
LOOPS**

Los alojamientos elásticos especiales aseguran y mantienen las herramientas en su lugar durante el transporte. Proporciona una gran flexibilidad a la hora de organizar herramientas y accesorios. Existen en una amplia variedad de nuestros productos para garantizar el máximo uso de los mismos. Los alojamientos son capaces de adaptarse perfectamente a todas las herramientas y accesorios.



**SIDE-GATE
SOLUTION**

El soporte lateral permite colocar fácilmente la herramienta sin mirar el portaherramientas. Una función de giro adicional garantiza que la herramienta se mantenga en un ángulo cómodo. Fabricado con acero inoxidable para una mayor longevidad del producto y fijado con cuatro remaches para mayor resistencia.



**BELT LOOP
HOLDER**

La correa con presilla de sujeción es resistente y posibilita colgar cualquier cosa con un mosquetón. Mantiene la herramienta o el accesorio seguro, lo que permite que un bolsillo quede libre. La presilla para cinturón se desliza sobre el cinturón y permanece enganchada de forma segura.



**RAIL GUIDE
SYSTEM**

El sistema de guía de carril es un sistema de organización extremadamente versátil. Una combinación perfecta de guías laterales de plástico y separadores que permite la personalización de compartimentos individuales. Los separadores están hechos de paneles de núcleo estructural de 3 capas. Cada separador se puede mover a lo largo de carriles ubicados en las paredes laterales.



Sistema de correa



STRAP

Función de correa

Totalmente nuevo en el mercado: el exclusivo sistema de cinturón / correa con hebillas de liberación rápida en los extremos hace que sea muy polivalente. Usándolo con una cómoda hombrera de goma suave hace que el levantamiento del portaherramientas sea más cómodo. Se adapta a todos los portaherramientas Makita.



E-05446*
Portaherramientas cerrado



E-05418*
Portaherramientas ajustable



E-05424*
Maletín portaherramientas reforzado



E-05620*
Nevera con correa

E-05446*
Portaherramientas cubierto

E-05480*
Organizador con cuatro bolsas



E-05430
Portaherramientas abierto con asa



E-05474*
Organizador con tres bolsas

Más de **40** productos con este sistema

E-05549*
Bolsa para sierra de cadena



E-05670
Funda para guía de carril 1m



E-05664
Funda para guía de carril 1,4m / 1,5m



E-05452*
Bolsa portaherramientas grande



E-05577*
Bolsa de lona



E-05505*
Bolsa para herramientas y ordenador portátil



E-05496*
Bolsa semi-rígida



E-05468
Bolsa portaherramientas

E-05561
Bolsa de tubo contra todo clima



STRAP BELT SYSTEM

BELT



Función de cinturón.
 La correa se puede quitar fácilmente de cualquier portaherramientas y llevarse a la cintura como un cinturón de herramientas de uso ligero. La correa se puede ajustar, lo que es flexible y conveniente para adaptarse a sus necesidades. Se puede usar con cualquier portaherramientas Makita.



E-05583
 Funda para móvil vertical



E-05256*
 Portaherramientas con clip



E-05309*
 Set de correa con presilla (3 unds)
E-05315*
 Set de correa con presilla (6 unds)



E-05212
 Portaherramientas electricista



E-05228
 Portamartillos con tres alojamientos



E-05278
 Portaflexómetro



E-05240
 Portamartillo



E-05234
 Portamartillo con cierre



E-05262
 Portatijera de poda



E-05599*
 Portabotella térmica



E-05608*
 Portatermo



E-05181
 Bolsa para electricista



E-05131
 Bolsa multiusos doble



E-05147
 Organizador con tres bolsas



E-05153
 Bolsa para carpintero



E-05125*
 Bolsa con cartuchera



E-05094
 Cartuchera grande universal

E-05103*
 Portalápiz universal

E-05284*
 Portacincel y herramientas

E-05206
 Portaobjetos



E-05197
 Portaclavos con sujeción de martillo

E-05119
 Cartuchera pequeña

* Consultar disponibilidad



Iconos y tecnologías 324 - 326

Sistema de correa 327 - 330

Portaherramientas 331 - 350















Cinturones y tirantes 351 - 358

Maletines, bolsas y mochilas 359 - 366

Ropa, equipamiento y fundas 367 - 374

Iconos:

Materiales:

-  **Poliéster 600D**
-  **Poliéster 1680D**
-  **Cuero de alta calidad**
-  **Material de goma**
-  **Malla**
-  **Material antideslizante**
-  **Malla transpirable**
-  **Material triplex**
-  **Poliétileno de alta densidad**
-  **Lámina aislante térmica**
-  **Correas ajustables**
-  **Gancho y mosquetón**
-  **Banda elástica**
-  **Cinta de polipropileno**
-  **Cremallera**

Herrajes y accesorios:

-  **Asa de plástico**
-  **Asa de goma**
-  **Asa de metal**
-  **Mango de cinta de polipropileno con almohadilla**
-  **Mosquetón de aluminio**
-  **Mosquetón**
-  **Base metálica**
-  **Botón de presión**
-  **Ollaos**
-  **Remache**
-  **Cinturón de doble agujero**
-  **Tirador**
-  **Regulador**
-  **Ajuste de cinta**
-  **Cierre de cinturón**
-  **Pinza de liberación rápida**
-  **Hebilla de liberación rápida**
-  **Correa para el hombro acolchada**
-  **Correa con almohadilla de goma**
-  **Marco de aluminio**
-  **Equipaje de mano**
-  **Portapuntas**
-  **Lateral portamartillos**
-  **Portamartillos deslizante**
-  **Portamartillos fijo**
-  **Cinta aislante para cadena**
-  **Clip para cinta métrica**
-  **Bolsillo para smartphone**
-  **Bolsillo para ordenador portátil**
-  **Bolsillo para documentos**
-  **Alojamiento para tarjetas de visita**
-  **Alojamiento para bolígrafos**
-  **Alojamiento para cutter**
-  **Alojamiento para destornillador**
-  **Alojamiento para brocas**
-  **Alojamiento para lijas manuales**
-  **Alojamiento para tenazas**
-  **Alojamiento para mosquetón**



Cinturón / Correa de cierre rápido

- La solución única como cinturón de herramientas de uso ligero.
- Se adapta a todas las bolsas y portaherramientas, además de a los estuches de herramientas.
- Este cinturón básico es perfecto para diversas actividades laborales y cuenta con hebilla de liberación rápida.
- Sirve como base para construir tu propio juego de cinturón personalizado con las herramientas que te sean necesarias.



STRAP/BELT
SYSTEM



La solución única para usar como cinturón de herramientas manuales.

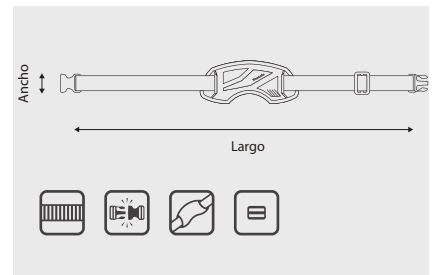

- 1 Hebilla de polipropileno de 40mm.
- 2 Hombreira con diseño ergonómico.
- 3 Regulador de longitud.
- 4 Correa de alta resistencia en azul Makita.



Hebilla de cierre rápido.

Medidas (L x An x Al)	Peso (Kg)	Capacidad (L)	Unds.	Código	EAN	P.V.P (€)
1300 x - x 38 mm	0,18	-	1	E-05290	0088381566803	11,85

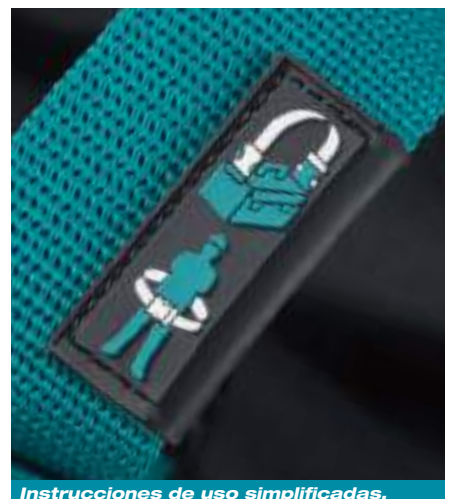

Instrucciones de uso simplificadas.

Make It Right, Make It Makita

TECNOLOGÍAS

STRAP / BELT SYSTEM

ANTI SLIP

3 LAYERS

ELASTIC LOOPS

3D SHAPED POUCHES

SIDE-GATE SOLUTION

BELT LOOP HOLDER

DURABLE RIVETING

REAL LEATHER



Cartuchera grande universal

- 2 alojamientos elásticos a los lados.
- 2 alojamientos para brocas de cuero auténtico.
- Libera las manos para moverse con seguridad en escaleras, techos y andamios.
- Portaherramientas equilibrado: sostiene la mayoría de taladros de todas las marcas.
- Herramientas accesibles, una única posible posición para un mejor equilibrio.
- Hecho de poliéster 1680D, resistente para mayor durabilidad.



STRAP BELT SYSTEM

ANTI SLIP

3 LAYERS

3D SHAPED POUCHES

REAL LEATHER

DURABLE RIVETING

ELASTIC LOOPS



Cinta de cuero auténtico con botón de presión que sujeta con seguridad el taladro al subir o bajar de escaleras

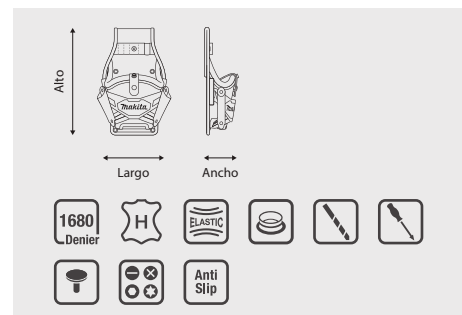

- 1 Los remaches y arandelas de níquel para mayor resistencia y un uso duradero.
- 2 Alojamiento para brocas hecho de cuero auténtico para un práctico y sencillo almacenamiento.
- 3 Los alojamientos laterales para diversas herramientas y accesorios ofrecen muchas opciones.
- 4 Cinta antideslizante con superficie de goma en la parte superior para evitar accidentes por resbalones y caídas en el lugar de trabajo.
- 5 Alojamientos elásticos para brocas proporcionan un almacenamiento conveniente.
- 6 Botones de presión de acero para inmovilizar la correa de seguridad cuando se usa el taladro.
- 7 Los dos botones de presión hacen que la funda sea universal para usar con máquinas de diferentes tamaños.

Medidas (L x An x Al)	Peso (Kg)	Capacidad (L)	Unds.	Código	EAN	P.V.P (€)
170 X 85 X 290 mm	0,3	-	1	E-05094	0088381566605	28,00



Muy cómodos para zurdos y diestros.

Herramientas no incluidas

Cartuchera pequeña

- Fabricado para ser duradero y a su vez ligero.
- Se puede usar en cualquier cinturón de herramientas Makita o cinturón de ropa normal.
- Fácil de manejar con una mano.
- 2 alojamientos elásticos especiales para una mayor organización.
- 2 alojamientos especiales para brocas y un alojamiento abierto para el adaptador de cambio rápido.
- Libera las manos para moverse con seguridad en escaleras, techos y andamios.

STRAP/BELT SYSTEM

ANTI SLIP

3 LAYERS

3D SHAPED POUCHES

REAL LEATHER

DURABLE RIVETING

ELASTIC LOOPS



Cinta de cuero auténtico con botón de presión que sujeta con seguridad el taladro al subir o bajar de escaleras

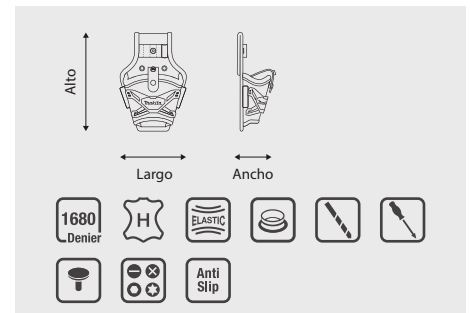

- 1 Los alojamientos elásticos para brocas ofrecen un práctico almacenamiento.
- 2 Botones de presión de acero inoxidable.
- 3 Alojamiento elástico especial para adaptador de cambio rápido. Su construcción abierta aporta mayor comodidad.
- 4 Cinta antideslizante con superficie de goma en la parte superior para evitar accidentes por resbalones y caídas en el lugar de trabajo.
- 5 Los remaches y arandelas niquelados aportan mayor resistencia y una vida útil más larga.
- 6 Botones de presión de acero inoxidable para inmovilizar la correa de seguridad cuando se usa con un taladro.
- 7 Los alojamientos laterales para diversas herramientas y accesorios ofrecen una amplia variedad de posibilidades.
- 8 Elegante diseño de malla Makita.

Medidas (L x An x Al)	Peso (Kg)	Capacidad (L)	Unds.	Código	EAN	P.V.P (€)
155 x 75 x 235 mm	0,13	-	1	E-05119	0088381566629	20,10



Muy cómodos para zurdos y diestros.

Bolsa con cartuchera

- Seguro, práctico y cómodo. Todo en uno.
- 4 alojamientos de cuero auténtico.
- 6 alojamientos elásticos para una perfecta organización.
- Cuenta con una bolsa grande y profunda para herramientas.
- Interior forrado de poliéster resistente que resiste años de desgaste.
- Mantiene herramientas accesibles cuando se necesitan. ¡Solo cógelas y a trabajar!

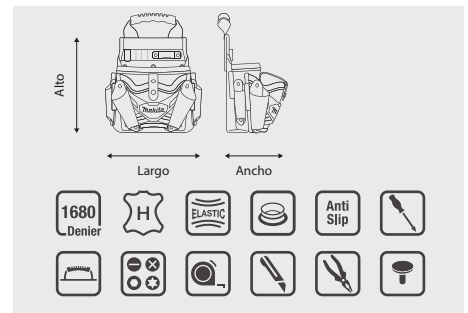

- 1 Correas antideslizantes con superficie de goma en la parte superior.
- 2 Portacutter de cuero auténtico.
- 3 Los dos botones de presión de metal hacen que la funda sea más versátil para usar máquinas de diferentes tamaños.
- 4 Su asa ergonómica antideslizante proporciona un transporte más cómodo.
- 5 Los alojamientos elásticos para brocas brindan un práctico almacenamiento.
- 6 Cinta con botones de presión fabricada en acero inoxidable.
- 7 Alojamientos elásticos para herramientas y sus accesorios más esenciales.
- 8 El alojamiento para destornilladores hecho de cuero auténtico proporciona un práctico almacenamiento en el interior.

Medidas (L x An x Al)	Peso (Kg)	Capacidad (L)	Unds.	Código	EAN	P.V.P (€)
260 x 145 x 270 mm	0,55	1,5	1	E-05125	0088381566636	55,00



Bolsa multiusos doble

- Perfecto portaherramientas para empezar junto con el cinturón de herramientas.
- 2 bolsillos grandes para llevar todas las herramientas y accesorios necesarios.
- 3 alojamientos de cuero auténtico.
- 4 alojamientos elásticos para herramientas.
- La presilla para colgar varias herramientas y accesorios permite un almacenamiento rápido.
- Forro interior de poliéster duradero para resistir los años de desgaste.



La presilla para colgar varias herramientas y accesorios proporciona un almacenamiento fácil y rápido.

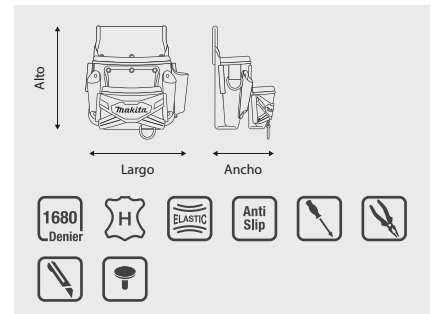

- 1 Portadestornillador de cuero auténtico.
- 2 Ancho alojamiento de cuero auténtico para cutter.
- 3 El bolsillo frontal tiene muchas posibilidades y además, proporciona una identificación rápida de las herramientas.
- 4 Presilla para colgar diversas herramientas y accesorios.
- 5 Banda elástica especial para destornilladores y otras herramientas pequeñas.
- 6 Correas antideslizantes con superficie de goma.
- 7 Bolsillo principal con cincha antideslizante.
- 8 El remache extra de la bolsa proporciona una vida útil más duradera.

Medidas (L x An x Al)	Peso (Kg)	Capacidad (L)	Unds.	Código	EAN	P.V.P (€)
290 x 145 x 270 mm	0,66	2,9	1	E-05131	0088381566643	38,00



Portaherramientas elásticos en el interior

Bolsa para electricistas

- Diseñado para cumplir con las necesidades del electricista profesional.
- 12 alojamientos elásticos en la parte delantera.
- 8 cintas antideslizantes.
- 3 trabillas elásticas en los lados.
- 2 bolsillos grandes principales.
- 1 alojamiento de cuero y 2 soportes de poliéster a los lados.

STRAP BELT SYSTEM

ANTI SLIP

3 LAYERS

3D SHAPED POUCHES

REAL LEATHER

DURABLE RIVETING

ELASTIC LOOPS



Los alojamientos elásticos extra dentro del portaherramientas mantienen sus herramientas seguras, bien organizadas y en su sitio.

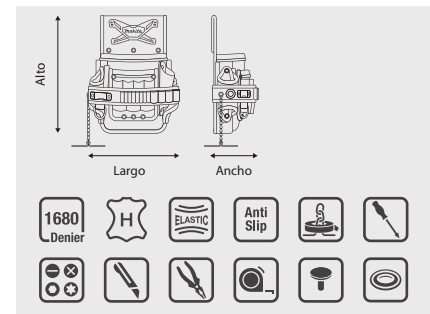

Medidas (L x An x Al)	Peso (Kg)	Capacidad (L)	Unds.	Código	EAN	P.V.P (€)
250 x 125 x 310 mm	0,55	1,70	1	E-05181	0088381566698	40,00

- 1 Cintas antideslizantes con superficie de goma en la parte superior.
- 2 Alojamiento de cuero auténtico especial para cutter.
- 3 Alojamiento elástico para destornilladores.
- 4 Portacinta métrica de acero inoxidable
- 5 Posibilidad de colgar un mosquetón en la presilla.
- 6 Gancho en forma de T.
- 7 Alojamiento elástico externo fuera del bolsillo principal.
- 8 Alojamiento para herramientas fabricados con poliéster de caucho resistente.
- 9 Bolsillo frontal para cualquier tipo de herramientas de electricista.
- 10 Alojamiento lateral adicional hecho de material de 3 capas.



Bolsillo principal para guardar herramientas de electricista

Herramientas no incluidas

Organizador con 3 bolsas

- 3 bolsillos espaciosos para una variedad de herramientas y accesorios.
- 2 alojamientos de cuero auténtico.
- Transportatodo: clavos, piezas, herramientas, tornillos, lápices, etc.
- Capaz de manejarse con una mano.
- Todas las herramientas necesarias al alcance de la mano.
- Contiene múltiples bolsillos y alojamientos para una perfecta organización.



Los alojamientos extra dentro de la bolsa ubicados en la pared trasera mantienen sus herramientas sujetas y seguras.

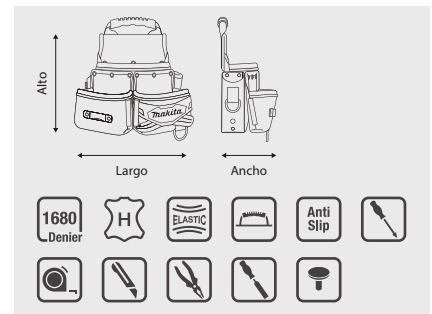

Medidas (L x An x Al)	Peso (Kg)	Capacidad (L)	Unds.	Código	EAN	P.V.P (€)
320 x 145 x 270 mm	0,67	3,3	1	E-05147	0088381566650	49,00



- 1 El portacincel, hecho de cuero auténtico, extra remachado, protege la herramienta correctamente.
- 2 La presilla para colgar varias herramientas y accesorios proporciona un almacenamiento extra, fácil y rápido.
- 3 Su asa ergonómica con cinta antideslizante proporciona un transporte cómodo.
- 4 El alojamiento de acero inoxidable para la cinta métrica sostiene cualquier cinta estándar de 3 a 10 m.
- 5 Alojamientos elásticos laterales para tener todas las herramientas y accesorios esenciales al alcance de la mano.
- 6 Remachas duraderos con arandelas para mayor resistencia.
- 7 Las correas antideslizantes con superficie de goma en la parte superior evitan accidentes por resbalones y caídas en el lugar de trabajo.
- 8 El organizador se coloca cómodamente en cualquier cinturón de herramientas Makita o cinturón de ropa normal.
- 9 Logotipo de Makita visible, moderno diseño de malla Makita.
- 10 El bolsillo frontal tiene muchas posibilidades y además, proporciona una identificación rápida de la herramienta o el accesorio.

Bolsa para carpintero

- Bolsa grande ideal para carpinteros, jardineros y/o todo personal de mantenimiento.
- Organice cuidadosamente una variedad de herramientas manuales y evite que se caigan.
- Se puede usar con cualquier herramienta.
- 3 alojamientos de cuero a los lados.
- 3 alojamientos elásticos azules.
- 2 presillas para colgar cualquier cosa con un mosquetón.



El portamartillo de acero inoxidable del lateral se balancea para mantener siempre el martillo en posición vertical.

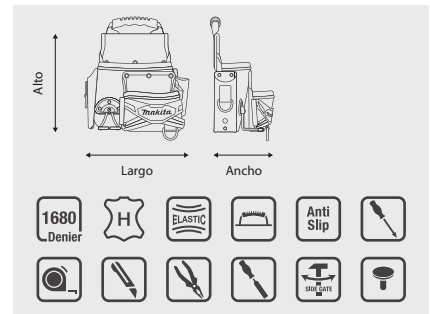

- 1 Alojamiento para destornillador de cuero auténtico.
- 2 Portacuchillos de cuero auténtico.
- 3 El bolsillo frontal ofrece muchas posibilidades y proporciona una identificación rápida de las herramientas.
- 4 Presilla para colgar varias herramientas y accesorios.
- 5 El portamartillo de acero inoxidable del lateral se balancea para mantener siempre el martillo en posición vertical.
- 6 Portacinceles, hecho de cuero auténtico, extraremachado, protege la herramienta correctamente.
- 7 Alojamientos elásticos para herramientas a los lados para tener todos los elementos esenciales a mano.
- 8 El asa ergonómica facilita el transporte.

Medidas (L x An x Al)	Peso (Kg)	Capacidad (L)	Unds.	Código	EAN	P.V.P (€)
290 x 145 x 270 mm	0,66	2,60	1	E-05153	0088381566667	55,00



Alojamientos elásticos extra dentro del portaherramientas

Portabolsas con correa

- Mantiene herramientas y accesorios al alcance de la mano, ¡solo en la cintura!
- 5 bolsillos espaciosos.
- 6 alojamientos de cuero con una resistencia y durabilidad fiables.
- 2 presillas para la correa incluidos.
- 10 alojamientos elásticos para un fácil acceso a las herramientas y destornilladores adicionales fuera de los bolsillos.



ANTI SLIP

3 LAYERS

3D SHAPED POUCHES

REAL LEATHER

DURABLE RIVETING

ELASTIC LOOPS

SIDE-GATE SOLUTION

BELT LOOP HOLDER



Dos bolsillos principales profundos para un almacenamiento seguro de las herramientas, 2 bolsillos delanteros y un bolsillo más pequeño en el medio.

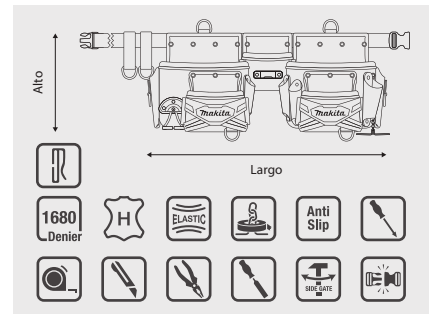

Medidas (L x An x Al)	Peso (Kg)	Capacidad (L)	Unds.	Código	EAN	P.V.P (€)
640 x 145 x 270 mm	1,34	6,50	1	E-05169	0088381566674	113,00



 Herramientas no incluidas

Tres bolsas Cinco bolsillos Treinta alojamientos



- 1 Presilla en el extremo del cinturón para evitar que se caiga.
- 2 2 presillas para cinturón incluidos.
- 3 Presilla para colgar varias herramientas y accesorios.
- 4 Portacincel, hecho de cuero auténtico.
- 5 Presilla adicional para usar con mosquetón.
- 6 Portamartillo de acero inoxidable.
- 7 Alojamiento elástico en el interior de los bolsillos principales.
- 8 Presillas.
- 9 2 presillas para colgar cualquier útil con mosquetón.
- 10 Portadestornillador de cuero auténtico.
- 11 Construcción robusta con varios remachaes adicionales.
- 12 Portacinta métrica de acero inoxidable.
- 13 Portaherramientas de cuero.
- 14 Alojamiento especial para destornilladores.
- 15 Bolsillo frontal de muchas posibilidades y herramientas más pequeñas.
- 16 Alojamiento elásticos especiales dentro del bolsillo principal.
- 17 Correas antideslizantes con superficie de goma en la parte superior.
- 18 Portacutter de cuero auténtico.
- 19 Gancho en forma de T
- 20 Gancho en forma de hebilla de 40 mm de liberación rápida.



Se adapta a todos los tamaños de cintura

Cinturón completo

- Distribuye el peso de las herramientas de manera uniforme alrededor de la cintura para mayor comodidad durante el día.
- Totalmente personalizable. Se puede cargar con varios tipos de portaherramientas.
- Conjunto de cinturón extra cómodo para trabajos pesados con todo el equipo necesario alrededor de la cintura.
- Capaz de guardar todo: repuestos, herramientas, brocas, lápices, etc. (accesorios y herramientas no incluidos).
- Acolchado de malla transpirable para el calor y el frío.



STRAP/BELT SYSTEM

ANTI SLIP

3 LAYERS

3D SHAPED POUCHES

REAL LEATHER

DURABLE RIVETING

ELASTIC LOOPS

BELT LOOP HOLDER



2 bolsillos principales de gran tamaño para el almacenamiento seguro de las herramientas, 2 bolsillos delanteros de amplias posibilidades y un bolsillo más pequeño en el medio.

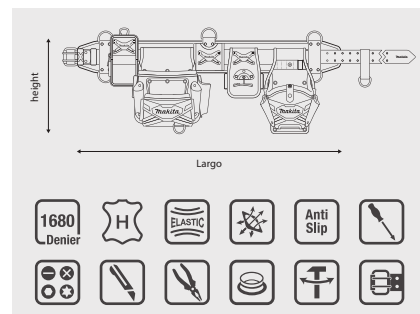

Medidas (L x An x Al)	Peso (Kg)	Capacidad (L)	Unds.	Código	EAN	P.V.P (€)
310 x - x 880 mm	1,73	2,78	1	E-05175	0088381566681	139,00



Soporte para teléfono móvil con bolsillos elásticos delanteros.

Cuarenta alojamientos y diversos bolsillos



Logo visible Makita en el portaherramientas.

- 1 Hebilla de cinturón con doble pasador para mayor resistencia y seguridad.
- 2 Trabilla de cinturón Makita.
- 3 Trabilla de cinturón de cuero.
- 4 Presilla para enganchar tirantes.
- 5 Útil presilla para colgar cualquier útil con mosquetón.
- 6 Cierre con cremallera.
- 7 Bolsillo principal plano elástico en color azul Makita.
- 8 Bolsillo plano extra elástico en la parte delantera del cinturón.
- 9 Alojamiento elásticos laterales para herramientas pequeñas.
- 10 Presilla para colgar varias herramientas y accesorios.
- 11 Bolsillo principal grande para el almacenamiento seguro de todas sus herramientas principales.
- 12 Bolsillo frontal para las herramientas más pequeñas.
- 13 Cinta antideslizantes con superficie de goma en la parte superior.
- 14 Presilla adicional.
- 15 Alojamiento especial para destornillador de cuero auténtico.
- 16 Alojamiento especial para cutter de cuero auténtico.
- 17 Logotipo de Makita claramente visible en la parte posterior.
- 18 Alojamiento elástico especial para destornilladores.
- 19 Soporte de martillo resistente forjado en acero inoxidable.
- 20 Portamartillo con capacidad de balanceo para mantenerse siempre en posición vertical.
- 21 Mezcla de cuero y cinta de polipropileno resistente.
- 22 Alojamiento para destornillador de cuero auténtico.
- 23 Alojamiento elástico para brocas en color Makita.
- 24 Botón de presión adicional para inmovilizar la correa.
- 25 Alojamiento elástico para adaptador de cambio rápido.
- 26 Botones de presión para enganchar y desenganchar rápidamente.
- 27 Cintas antideslizantes con superficie de goma en la parte superior.
- 28 Construcción robusta con remaches de refuerzo.
- 29 Trabilla de 2 capas.
- 30 La parte principal del cinturón está hecha de cuero de alta calidad.
- 31 Cinta con presilla incluida adicionalmente en el cinturón.
- 32 Doble hilera de orificios para mayor resistencia y seguridad.
- 33 Logotipo visible de Makita grabado en el cinturón.



- Bolsillo principal grande para guardar de forma segura sus herramientas y accesorios.
- Alojamiento especial de cuero auténtico para cutter.
- Remaches para una resistencia y durabilidad verdaderamente irrompibles.
- Bolsillo frontal para fijaciones y herramientas más pequeñas.

- Hecho de poliéster resistente de 1680D.
- Fuertes costuras industriales para mayor durabilidad.
- Correas antideslizantes con superficie de goma en la parte superior del cinturón.
- Numerosos alojamientos elásticos para brocas y adaptadores de brocas.
- Dos botones de presión de metal lo hacen más versátil.



Cinta de cuero auténtico con botón de presión metálico.



Portaherramientas correctamente ubicado en un lateral.

Portaclavos con portamartillo

- Para cualquier tipo de trabajo: constructores, carpinteros, mecánicos, electricistas, trabajadores, etc.
- Se adapta cómodamente a cualquier cinturón Makita.
- Transporta todo: clavos, piezas, herramientas, tornillos, lápices, etc.
- Cómodo de llevar, mantiene las herramientas al alcance de la mano.
- Un buen inicio para empezar tu juego de portaherramientas Makita.



STRAP/BELT SYSTEM

ANTI SLIP

3 LAYERS

3D SHAPED POUCHES

REAL LEATHER

DURABLE RIVETING

ELASTIC LOOPS

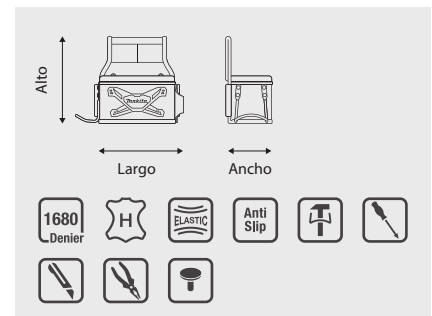

Los alojamientos elásticos mantienen las herramientas seguras y fijas.

Medidas (L x An x Al)	Peso (Kg)	Capacidad (L)	Unds.	Código	EAN	P.V.P (€)
180 x 105 x 185 mm	0,25	1,25	1	E-05197	0088381566704	25,00

- 1 Cintas antideslizantes con superficie de goma en la parte superior.
- 2 Alojamiento elástico para herramientas más pequeñas.
- 3 Bolsillo principal muy versátil.
- 4 Portamartillo de acero inoxidable.
- 5 Alojamiento de cuero diseñado para pinzas.



También para jardín

Portaclavos con portamartillo

Herramientas no incluidas

Portaobjetos con cremallera

- Libera las manos para que pueda moverse con seguridad en escaleras, techos y andamios.
- Portaobjetos perfecto para diversas actividades laborales.
- Se adapta cómodamente a cualquier cinturón Makita.
- Mantiene sus herramientas a mano cuando se necesitan.
- Seguro, práctico y cómodo.
- Espacio para clavos, piezas, herramientas, juegos de clavos, lápices, etc.

STRAP BELT SYSTEM

3 LAYERS

3D SHAPED POUCHES

DURABLE RIVETING

ELASTIC LOOPS



Portacinta métrica de acero inoxidable para cualquier cinta métrica estándar de 3 a 10 m. La solución perfecta para tus baterías.

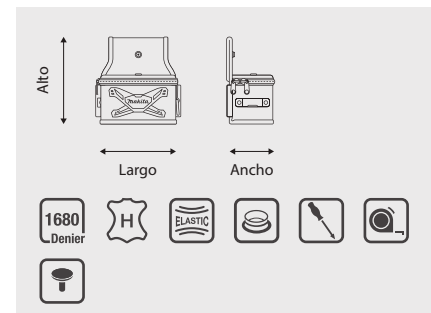

Medidas (L x An x Al)	Peso (Kg)	Capacidad (L)	Unds.	Código	EAN	P.V.P (€)
175 x 105 x 185 mm	0,24	1,0	1	E-05206	0088381566711	25,00

- 1 Con cremallera para un almacenamiento seguro, antipolvo.
- 2 Botones de presión.
- 3 El bolsillo principal tiene capacidad para dos baterías.
- 4 Presilla para colgar cualquier cosa con enganche de mosquetón.
- 5 Alojamiento especiales adicionales para destornilladores.



Portaobjetos con alojamientos elásticos

Portaherramientas especial electricista

- Se puede llevar de 4 formas diferentes, incluido en el cinturón.
- Alojamiento seguro en cualquier posición de trabajo.
- 5 alojamientos elásticos para herramientas en la parte delantera para un almacenamiento práctico.
- 2 alojamientos de cuero para mayor resistencia.
- 2 alojamientos de poliéster en los lados para una mejor organización.

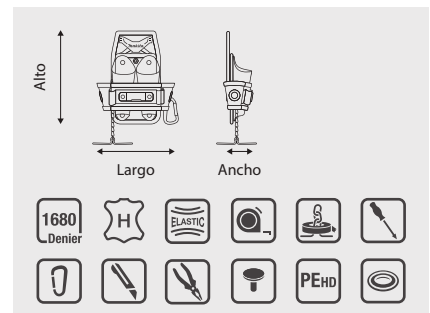

Los alojamientos elásticos mantienen las herramientas seguras y en su lugar inmovilizando las herramientas más largas.

Medidas (L x An x Al)	Peso (Kg)	Capacidad (L)	Unds.	Código	EAN	P.V.P (€)
185 x 55 x 205 mm	0,28	-	1	E-05212	0088381566728	25,00

- 1 Tornillo regulador de la intensidad ocasionada por el balanceo.
- 2 Portacinta métrica de acero inoxidable.
- 3 2 alojamientos elásticos laterales para herramientas.
- 4 2 alojamientos laterales versátiles que sujetan de forma segura las herramientas más grandes y pesadas.
- 5 Mosquetón negro para enganchar cualquier tipo de objeto.
- 6 2 alojamientos de cuero versátiles para una organización segura de las herramientas más grandes.
- 7 El gancho en forma de T.
- 8 Reverso reforzado para mayor ergonomía.



Tornillo para regular la intensidad del balanceo

Herramientas no incluidas

Portaherramientas completamente giratorio. 4 modos de ajuste



Balaceo para mantener las herramientas siempre en posición vertical

- Reverso de polipropileno para mantener la rigidez y la forma óptima deseada.
- Alojamiento elástico lateral para tener todas las herramientas y accesorios a mano.
- El portacinta métrica sostiene cualquier cinta estándar de 3 a 10 m.



El portaherramientas se puede colgar en el bolsillo del pecho.



En el bolsillo del pantalón.



En el bolsillo delantero: más comodidad al arrodillarse.



Forma tradicional de llevar el portaherramientas en un cinturón.



Portamartillo

- El soporte de acero inoxidable se adapta a cualquier martillo.
- 2 alojamientos elásticos adicionales para lápiz o destornillador.
- Se adapta a cualquier cinturón Makita.
- Hecho de poliéster duradero para soportar años de desgaste.
- Portaherramientas básico perfecto para diversas actividades laborales.
- Makita: la marca más reconocida en productos de ropa de trabajo.



El soporte del martillo de acero inoxidable de se balancea para mantener el martillo siempre en posición vertical.

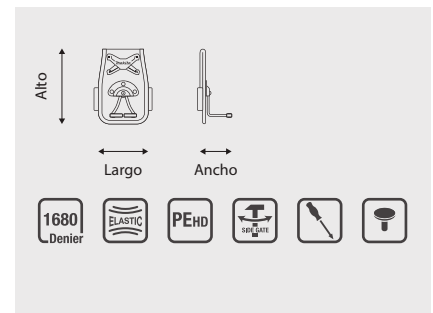

Medidas (L x An x Al)	Peso (Kg)	Capacidad (L)	Unds.	Código	EAN	P.V.P (€)
880 x 30 x 100 mm	0,66	-	1	E-05234	0088381566742	15,45

- 1 Soporte del martillo de acero inoxidable.
- 2 Polipropileno para mantener la rigidez.
- 3 Alojamientos elásticos para todos accesorios esenciales.
- 4 Cinturón de hasta 50 mm de ancho.
- 5 Balanceable para mantener el martillo siempre en posición vertical.



Herramientas no incluidas

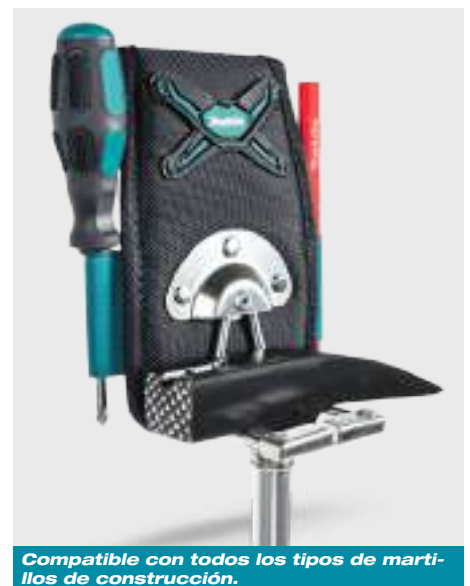

Compatible con todos los tipos de martillos de construcción.

Portamartillos con cierre

- Portaherramientas de acero inoxidable para martillos o hachas.
- 2 alojamientos elásticos laterales.
- Seguro, práctico y cómodo.
- Mantiene las herramientas al alcance de la mano.
- Se adapta perfectamente a cualquier cinturón Makita.
- Hecho de poliéster duradero para resistir los años de desgaste.

STRAP BELT SYSTEM

3 LAYERS

DURABLE RIVETING

ELASTIC LOOPS



Sostiene todo tipo de martillos para obreros, carpinteros y personal de construcción.

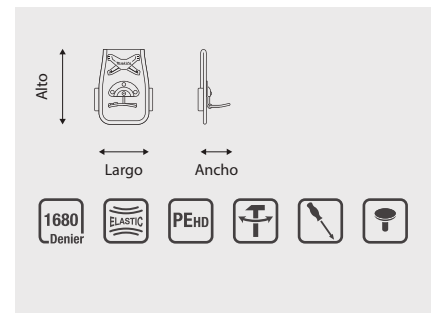

Medidas (L x An x Al)	Peso (Kg)	Capacidad (L)	Unds.	Código	EAN	P.V.P (€)
110 x 70 x 165 mm	0,15	-	1	E-05240	0088381566759	14,40

- 1 Portaherramientas de acero inoxidable para martillos.
- 2 Capaz de balancearse para que el martillo siempre quede en posición vertical.
- 3 Alojamiento elástico para todos los accesorios esenciales.
- 4 Las presillas se ajustan a un cinturón de hasta 50 mm de ancho.
- 5 Reverso de polipropileno para mantener la forma original.



Herramientas no incluidas



También para jardín

También puedes usar este portaherramientas en exteriores.

Portaflexómetro

- Portaflexómetro ajustable y fácil de usar.
- Especialmente diseñado con agujeros para medir sin sacar la cinta.
- 2 alojamientos elásticos para lápices, destornilladores y otros accesorios más pequeños.
- Hecho de poliéster duradero para resistir los años de desgaste.
- Construido para ser duradero pero ligero a su vez.
- Se puede usar en cualquier cinturón de herramientas Makita o cinturón de ropa normal.
- Se puede utilizar para cintas métricas de 3 a 10 m.

STRAP BELT SYSTEM

ANTI SLIP

3 LAYERS

3D SHAPED POUCHES

DURABLE RIVETING

ELASTIC LOOPS



Cinta antideslizante con superficie de goma en la parte superior para evitar accidentes por resbalones y caídas en el lugar de trabajo.

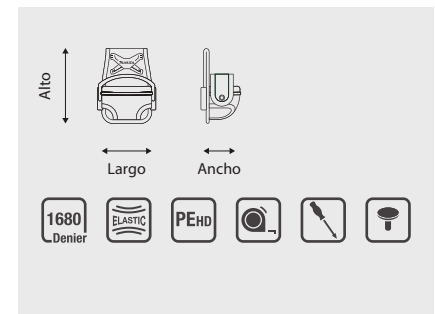

Medidas (L x An x Al)	Peso (Kg)	Capacidad (L)	Unds.	Código	EAN	P.V.P (€)
110 x 80 x 165 mm	0,14	-	1	E-05278	0088381566780	12,35

- 1 Alojamientos elásticos especiales para destornilladores y otras herramientas pequeñas.
- 2 Cierre para móviles abrochado con dos remaches laterales.
- 3 Solapa para asegurar la cinta métrica con opción de movimiento tanto hacia arriba como hacia abajo.
- 4 Cintas antideslizantes con superficie de goma en la parte superior
- 5 Se adapta cómodamente a cualquier cinturón Makita de hasta 50 mm de ancho.
- 6 Agujero en el lateral para un uso fácil sin quitar la cinta métrica.



La parte trasera rígida del portaflexómetro permite sacar la cinta fácilmente.

Herramientas no incluidas

Portatijera de poda

- Portaherramientas multiusos (especial tijera de poda) forrado con poliéster duradero para resistir el uso frecuente del accesorio.
- Forma ergonómica diseñada para ser muy versátil tanto para cuchillos, tijeras de podar y otras herramientas.
- 2 alojamientos elásticos adicionales en los lados para sujetar un destornillador o un lápiz.
- Pequeño pero con mucha utilidad. Mantiene las herramientas al alcance de la mano.
- La presilla se adapta a cinturones de hasta 50 mm de ancho.
- Libera las manos para moverse con seguridad en escaleras, techos, andamios, etc.

STRAP BELT SYSTEM

ANTI SLIP

3 LAYERS

3D SHAPED POUCHES

DURABLE RIVETING

ELASTIC LOOPS

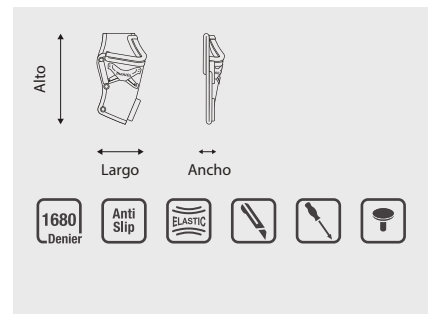

Medidas (L x An x Al)	Peso (Kg)	Capacidad (L)	Unds.	Código	EAN	P.V.P (€)
100 x 50 x 200 mm	0,08	-	1	E-05262	0088381566773	13,40

- 1 Cintas antideslizantes con superficie de goma en la parte superior.
- 2 2 alojamientos elásticos para todos los accesorios importantes.
- 3 Forma especial para tijera de poda.
- 4 Se adapta cómodamente a cualquier cinturón Makita.
- 5 Remaches para mayor durabilidad y larga vida útil.



También para jardín

También puedes usar este portaherramientas en exteriores.

Herramientas no incluidas

Make It Right, Make It Makita



TECNOLOGÍAS

**STRAP / BELT
SYSTEM**

**HEAVY-LOAD
SUPPORT SYSTEM**

**ELASTIC
LOOPS**

**BELT LOOP
HOLDER**

**DURABLE
RIVETING**

**REAL
LEATHER**

Cinturón portabolsas

- Perfecto para empezar a montar un juego de portaherramientas personalizado.
- Para tareas muy pesadas. ¡Nunca te defraudará!
- Cómodo de usar incluso cuando se llevan herramientas o accesorios pesados.
- Acabado extremadamente duradero, acolchado extra grueso y hebilla de doble pasador.
- Útil presilla para cinturón incluida para colgar cualquier útil con mosquetón.
- Combinación de cuero resistente con cinta de poliéster ligera.

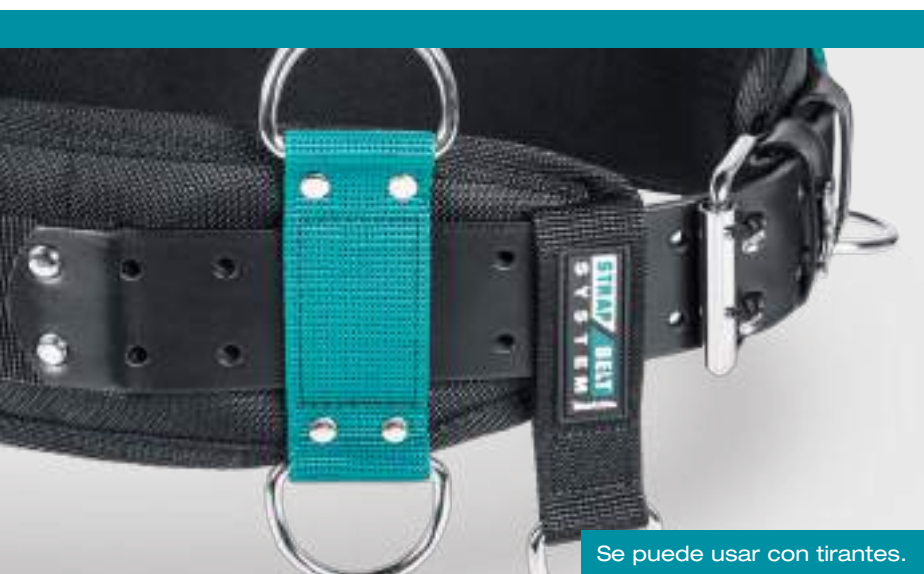

Se puede usar con tirantes.

Medidas (L x An x Al)	Peso (Kg)	Capacidad (L)	Unds.	Código	EAN	P.V.P (€)
880 x 30 x 100 mm	0,66	-	1	E-05321	0088381566834	46,00

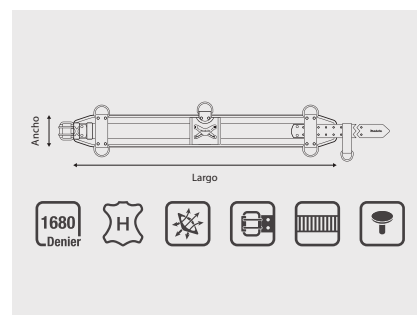

- 1 Hecho en parte de cuero auténtico de alta calidad.
- 2 Presillas de metal.
- 3 Presillas de metal adicionales para accesorios.
- 4 Soporte para cinturón incluido.
- 5 Remaches para una fuerza verdaderamente irrompible.
- 6 El reverso hecho de malla transpirable mantiene el flujo de aire.
- 7 Trabilla de cuero adicional para mantener el cinturón bien ajustado.
- 8 Logotipo de metal de Makita en la presilla del cinturón.
- 9 Hebilla de dos pines para mayor seguridad.
- 10 Dos filas de agujeros de 4,5 mm de diámetro.



Totally padded with 20 mm thick foam for greater comfort

Cinturón básico con cierre rápido

- Cinturón básico perfecto para diversos trabajos.
- Ideal para empezar a montar todo un kit de portaherramientas.
- Asegurado con una hebilla de plástico duradera de alta resistencia.
- Útil presilla incluida para colgar cualquier cosa con mosquetón.
- Construido para transportar múltiples bolsas de trabajo ligeras.
- Costuras dobles alrededor del cinturón para garantizar que las telas no se desprendan ni se deshilachen.



Correa de polietileno en el interior para mantener la forma del cinturón y evitar que se deforme

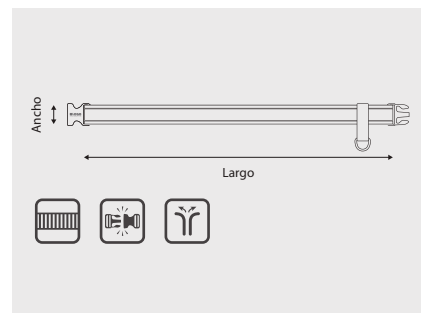

- 1 Hebilla de polipropileno de 50 mm de cierre rápido.
- 2 Presilla incluida.
- 3 Adecuado para usar con cualquier bolsa o portaherramientas Makita.
- 4 Interior de gancho y bucle para ajuste de longitud.
- 5 Logotipo de Makita grabado en la hebilla.

Medidas (L x An x Al)	Peso (Kg)	Capacidad (L)	Unds.	Código	EAN	P.V.P (€)
1550 x - x 50 mm	0,25	-	1	E-05337	0088381566841	16,50



Logotipo de Makita grabado en la hebilla

Cinturón de cuero con hebilla metálica



- Hecho de una sola pieza de cuero auténtico.
- Construcción robusta con remaches.
- A los fans de Makita les encantará. Ideal para el trabajo, y para el uso diario.
- Hebilla metálica y cinturón de cuero negro de 50 mm de ancho.
- Útil presilla incluida para colgar cualquier cosa con mosquetón.
- Makita: la marca más reconocida en productos de ropa de trabajo

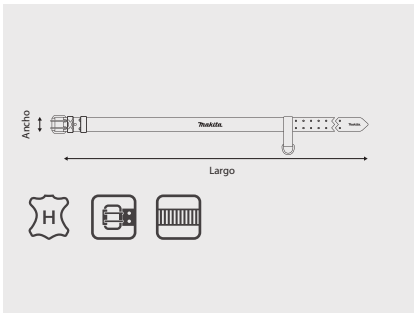

Confeccionado con cuero auténtico de una sola pieza de primera calidad de 50 mm de ancho. Se adapta a todos los tamaños de cintura.

- 1 Dos filas de agujeros de 4,5 mm de diámetro.
- 2 Remaches para mayor resistencia.
- 3 Hebilla resistente y segura.
- 4 Hebilla práctica.
- 5 Presilla incluida.

Medidas (L x An x Al)	Peso (Kg)	Capacidad (L)	Unds.	Código	EAN	P.V.P (€)
1380 x - x 48 mm	0,30	-	1	E-05343	0088381566858	28,00



Logo metálico Makita en la trabilla del cinturón.



Make It Right, Make It Makita



TECNOLOGÍAS

**HEAVY-LOAD
SUPPORT SYSTEM**

ANTI SLIP

Tirantes portaherramientas

- Diseñado para un uso profesional.
- Con enganche para smartphone.
- Estructura anti-deslizante, no se resbalará ni se descolocará de los hombros del usuario.
- Ligera y cómoda, manteniendo una alta resistencia y durabilidad.
- Ajuste de correa del pecho para adaptarse al tipo de cuerpo del usuario.
- Puede combinarse con portabolsas o cinturones completos para una mayor capacidad y mejora de rendimiento.

HEAVY-LOAD
SUPPORT SYSTEM

ANTI SLIP



Con un diseño ergonómico que mantiene los tirantes en su posición óptima durante todo el tiempo de uso. Reduce la fatiga del usuario.

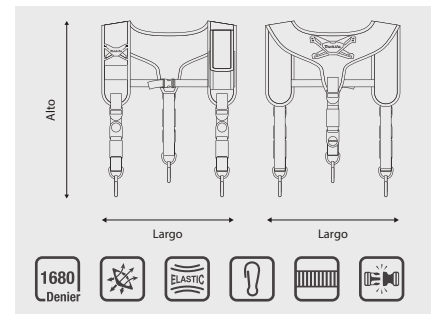

- 1 Parte inferior hecha de malla 3D para mejorar la transpiración.
- 2 Laterales elásticos del enganche para smartphones.
- 3 Hombreras adaptativas ergonómicas.
- 4 Ajustadores de longitud.
- 5 Sistema anti-deslizante que mantiene las hombreras en posición
- 6 Enganche para smartphones.
- 7 Hebilla de cierre rápido de 25mm en la correa del pecho.
- 8 Cintas elásticas para inmovilizar las correas de ajuste de longitud.
- 9 Anillas para ajuste rápido de longitud.
- 10 Mosquetones metálicos para conectarse al cinturón.

Medidas (L x An x Al)	Peso (Kg)	Capacidad (L)	Unds.	Código	EAN	P.V.P (€)
520 - 23 - 410 mm	0,47	-	1	E-05393	0088381566902	40,00



Con parte de cinta antideslizante para poder colgar otras herramientas.

Herramientas no incluidas

Tirantes

- Para apoyar el peso de la cintura a los hombros.
- Totalmente ajustable, talla única.
- Tirantes de 3 puntos de ajuste que quita peso a la parte baja de la espalda.
- Duradero y hecho de una fuerte banda elástica azul.
- Se adapta tanto a pantalones de trabajo como a pantalones casuales o jeans.



Diseñado para adaptarse tanto a pantalones de trabajo como a pantalones o jeans casuales. Para verdaderos fanáticos de Makita.

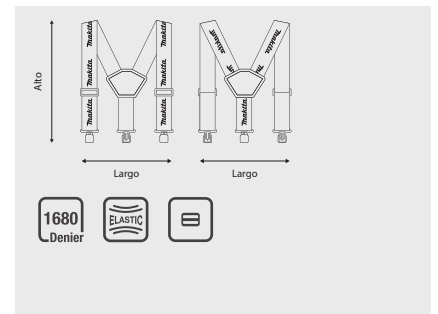

- 1 La almohadilla acolchada garantiza la comodidad del usuario.
- 2 Hecho de una fuerte banda elástica de 50 mm de ancho.
- 3 Metal niquelado de alta calidad.
- 4 Múltiples logotipos visibles de Makita.
- 5 Pinzas de acero de alta resistencia.

Medidas (L x An x Al)	Peso (Kg)	Capacidad (L)	Unds.	Código	EAN	P.V.P (€)
50 x - x - mm	0,24	-	1	E-05402	0088381566919	24,00



También para jardín

Talla única para todos...

- Diseñados para distribuir el peso entre la cintura y los hombros.
- Recién diseñados en color azul Makita con grandes logotipos de Makita en color blanco.
- El color y el logotipo reconocibles con poca visibilidad.



Pinzas de sujeción resistentes

- Cómodos tirantes de longitud ajustable.
- Fuertes costuras industriales para mayor durabilidad.
- Diseñado para uso profesional.
- Totalmente ajustable, talla única.



Unión acholchada por las dos caras



Talla única.



Make It Right, Make It Makita

TECNOLOGÍAS

STRAP BELT SYSTEM

RAIL GUIDE SYSTEM

TOOL LOOPS SYSTEM

WATERPROOF BOTTOM

CS BACKPACK CARRYING SYSTEM

ELASTIC LOOPS

DURABLE RIVETING

3 LAYERS

ANTI SLIP



Maletín portaherramientas reforzado

- 20 alojamientos de plástico de varios tamaños.
- 1 bolsillo frontal para guardar documentación.
- 3 alojamientos elásticos para una gran flexibilidad.
- 4 compartimentos espaciosos y totalmente ajustables para una organización ideal.
- Se pueden guardar clavos, piezas, herramientas, juegos de clavos, lápices, etc.
- Perfecto para un electricista, techador, plomero, carpintero y otros...



El innovador sistema alojamientos para herramientas permite al usuario colocarlas sin tener que realizar ningún ajuste.

Medidas (L x An x Al)	Peso (Kg)	Capacidad (L)	Unds.	Código	EAN	P.V.P (€)
505 x 295 x 265 mm	3,80	32	1	E-05424	0088381566933	111,00

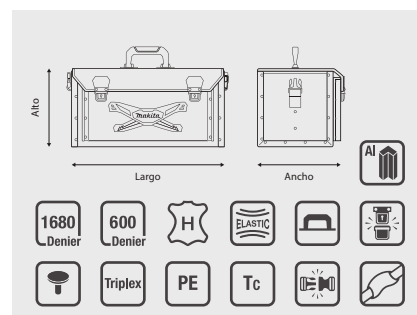

- 1 Guías de carril que dividen el maletín en diferentes compartimentos.
- 2 Innovador sistema alojamientos para herramientas manuales.
- 3 Bolsillo delantero para guardar la documentación u otro tipo de papeles.
- 4 Bloqueos para mantener las herramientas seguras e inmovilizadas.
- 5 Pared transversal.
- 6 Los bordes de aluminio evitan que la carcasa se dañe.
- 7 Correa con hebillas de liberación rápida.
- 8 Remaches para mayor resistencia.
- 9 Logotipo de Makita visible en el frente.
- 10 Refuerzo de solapa fuerte con interior reforzado metálico.



Bordes de aluminio contra posibles daños.

Portaherramientas abierto con asa

- 9 bolsillos exteriores de varios tamaños hechos de poliéster resistente.
- 2 bolsillos laterales con acabado elástico para mayor comodidad.
- 1 bolsillo frontal para la documentación u otros objetos planos.
- 8 alojamientos elásticos el interior de gran flexibilidad.
- 6 alojamientos elásticos en la parte posterior para las herramientas más largas.
- Hasta 30 herramientas en una posición segura.



- Almacena las herramientas verticalmente para facilitar su identificación.
- Su forma cuadrada mantiene el portaherramientas estable.
- Los alojamientos elásticos internos proporcionan una gran capacidad de organización de las herramientas.
- Capaz de portar hasta 30 herramientas manuales de cualquier tipo.
- Diseño abierto para un acceso rápido y sencillo al interior.
- Organice cuidadosamente una gran variedad de herramientas manuales, herramientas eléctricas y accesorios.

STRAP BELT SYSTEM

WATERPROOF BOTTOM

DURABLE RIVETING

ELASTIC LOOPS



El innovador sistema de alojamientos para herramientas permite al usuario colocar las herramientas manuales sin problemas.

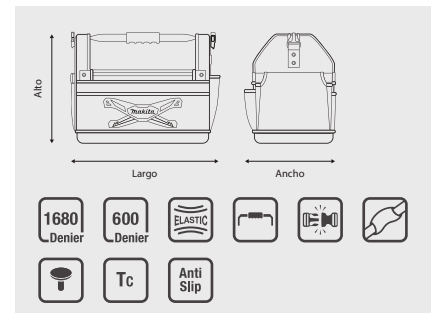

Medidas (L x An x Al)	Peso (Kg)	Capacidad (L)	Unds.	Código	EAN	P.V.P (€)
490 x 310 x 355 mm	2,44	29,70	1	E-05430	0088381566940	80,00



- 1 Asa ergonómica de espuma.
- 2 Asa de acero resistente.
- 3 Correa de liberación rápida
- 4 Base de correa de acero reforzado.
- 5 Costuras industriales para la correa.
- 6 Bolsillo frontal para la documentación.
- 7 Cómoda hombrera de diseño moderno.
- 8 Correa antideslizante con apoyo para hombro de goma.
- 9 Alojamientos elásticos en las paredes internas del portaherramientas.
- 10 Alojamientos elásticos en la pared trasera del bolso.



Bolsa portaherramientas

- Más de 20 bolsillos de distintos tamaños para una perfecta organización.
- Bolsa blanda básica perfecta para diversas actividades laborales.
- 9 bolsillos internos.
- 9 bolsillos externos.
- 4 alojamientos elásticos externos para herramientas largas.
- Ideal para llevar herramientas de mano y otros artículos pequeños.



STRAP/BELT SYSTEM

ELASTIC LOOPS



Bolsillos internos y externos para un almacenamiento seguro y ordenado.

Medidas (L x An x Al)	Peso (Kg)	Capacidad (L)	Unds.	Código	EAN	P.V.P (€)
440 x 240 x 250 mm	1,67	25,80	1	E-05468	0088381566971	65,00

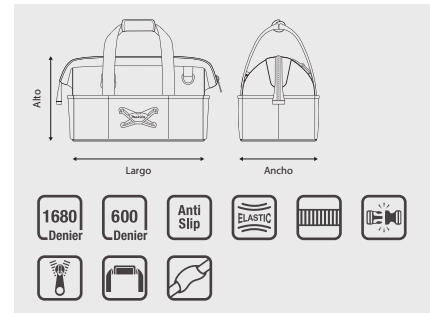

- 1 Gran apertura.
- 2 Acabado de cinta interna azul.
- 3 Cintas antideslizantes con superficie acolchada de goma.
- 4 Presilla para colgar diversas herramientas y accesorios.
- 5 Logotipo de Makita visible en el frontal.
- 6 Correa con hebilla de plástico.
- 7 Hombreira acolchada.
- 8 Cremallera de goma.
- 9 Hecho de poliéster 1680D resistente.
- 10 La forma cuadrada mantiene la bolsa estable en todo momento.



Capaz de portar una gran variedad de herramientas y accesorios.

Bolsa portaherramientas

- Alta capacidad de almacenamiento de 55L
- Cómoda incluso transportando elementos pesados.
- Con 10 compartimentos, 6 en el interior y 4 en el exterior, ideal para almacenar y organizar objetos de todos los tamaños.
- Estructura reforzada que mejora su durabilidad para soportar y transportar pesos pesados.
- Con varios tipos de asa para llevar en la mano o colgada del hombro.
- Estructura de tres capas que le da resistencia a las condiciones climáticas de exteriores.



STRAP/BELT SYSTEM

ANTI SLIP

3 LAYERS



Estructura reforzada para soportar pesos pesados y proporcionar un transporte cómodo.

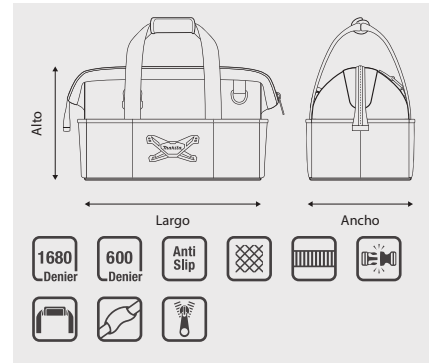

- 1 6 bolsillos exteriores.
- 2 4 bolsillos interiores.
- 3 Estructura reforzada para resistir el transporte de pesos pesados.
- 4 Material de triple capa con gran resistencia a condiciones climáticas adversas.
- 5 Posibilidad de transportar en mano o colgada del hombro.
- 6 Capacidad de 55L.

Medidas (L x An x Al)	Peso (Kg)	Capacidad (L)	Unds.	Código	EAN	P.V.P (€)
330 x 670 x 300mm	-	55	1	E-11782	0088381584159	108,00



Con cinta de velcro para unir ambas correas al transportarlo en mano.



Con instrucciones de uso acopladas de la correa de transporte al hombro.

Bolsa trolley reforzada

- Con trolley de transporte, puede almacenar gran cantidad de objetos y seguir siendo fácil de transportar a pesar del peso.
- Con una boca de apertura muy amplia para poder encajar objetos de grandes dimensiones.
- Con 10 compartimentos, 6 en el interior y 4 en el exterior, ideal para almacenar y organizar objetos de todos los tamaños.
- Estructura reforzada que mejora su durabilidad para soportar y transportar pesos pesados.
- Con varios tipos de asa para llevar en la mano o colgada del hombro.
- Estructura de tres capas que le da resistencia a las condiciones climáticas de exteriores.
- Alta capacidad de almacenamiento de 53,5L.



Con trolley incluido; lo que facilita su transporte incluso cuando incluya objetos pesados.

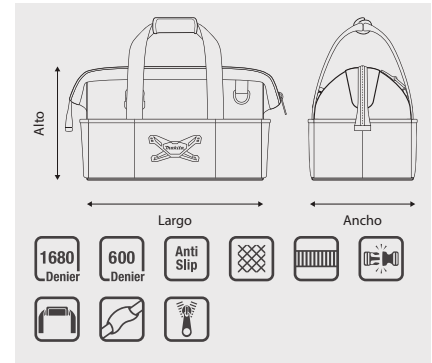

- 1 Amplia apertura principal.
- 2 Con trolley equipado.
- 3 Estructura reforzada para resistir el transporte de pesos pesados.
- 4 Material de triple capa con gran resistencia a condiciones climáticas adversas.
- 5 Posibilidad de transportar en mano o colgada del hombro.
- 6 Con gran cantidad de bolsillos exteriores e interiores.

Medidas (L x An x Al)	Peso (Kg)	Capacidad (L)	Unds.	Código	EAN	P.V.P (€)
330 x 680 x 330mm	-	53,5	1	E-12712	0088381588478	149,00



Con cinta de velcro para unir ambas correas al transportarlo en mano.



Con instrucciones de uso acopladas de la correa de transporte al hombro.

Make It Right, Make It Makita



TECNOLOGÍAS

B BACKPACK
C CARRYING
S SYSTEM

ELASTIC
LOOPS

WATERPROOF
BOTTOM

TOOL
LOOPS
SYSTEM

Mochila con organizador de herramientas

- Fácil organización y transporte de cualquier tipo de herramienta
- Ideal para trabajadores de la construcción, electricistas, obreros de reparaciones...
- Una alternativa más fácil de transportar que un maletín de herramientas.
- Permite tener las manos libres a la hora del transporte.
- Puede sujetar de manera segura hasta 50 herramientas manuales en una posición vertical.
- Con un gran número de compartimentos y enganches.

WATERPROOF
BOTTOM

CS BACKPACK
CARRYING
SYSTEM

TOOL
LOOPS
SYSTEM

ELASTIC
LOOPS



Bolsillo externo con cierre de solapa para un almacenaje seguro

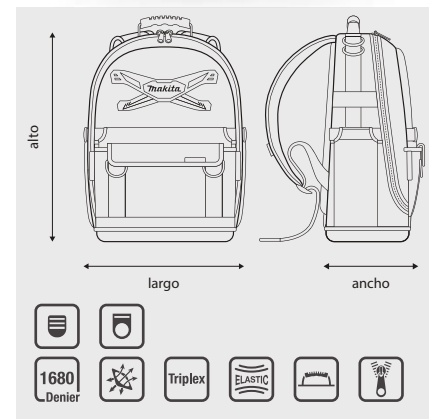

Medidas (L x An x Al)	Peso (Kg)	Capacidad (L)	Unds.	Código	EAN	P.V.P (€)
390 x 230 x 490mm	2,56	22,30	1	E-05511	0088381567022	149,00



- 1 Bolsillo lateral para herramientas largas.
- 2 Cinta elástica para mantener las herramientas en su posición y seguras.
- 3 Dos anillos para colgar herramientas que dispongan de un mosquetón.
- 4 Panel trasero reforzado.
- 5 Cinta lateral para mayor seguridad de las herramientas alargadas.
- 6 Carril de plástico para almacenar todo tipo de objetos.
- 7 Cintas para mantener herramientas fijas.
- 8 Cinta negra elástica para fijar herramientas cortas.
- 9 Cinta azul elástica para fijar herramientas de tamaño medio.
- 10 Cinta negra para inmovilizar herramientas alargadas.



Anillos para enganchar herramientas que dispongan de mosquetón.

Herramientas no incluidas

Make It Right, Make It Makita

TECNOLOGÍAS

**STRAP / BELT
SYSTEM**

ANTI SLIP

3 LAYERS

**ELASTIC
LOOPS**

**WATERPROOF
BOTTOM**

**DURABLE
RIVETING**

**LOOP-CLIP
SOLUTION**



Funda para móvil vertical

- Diseño moderno, también para uso diario. ¡A los fans de Makita les encantará!
- Ventaja única: enganche rápido en la parte posterior.
- El tamaño es universal, se adapta a los modelos de smartphone más populares.
- Práctico bolsillo frontal para tarjetas de visita, tarjetas de crédito o licencias...
- Mosquetón para las llaves, más el alojamiento elástico para bolígrafos
- Las múltiples capas de revestimiento de espuma y la malla de aire ofrecen la protección necesaria en el trabajo.



STRAP/BELT SYSTEM

ELASTIC LOOPS

LOOP-CLIP SOLUTION

3 LAYERS



Su diseño y construcción garantizan la máxima protección.

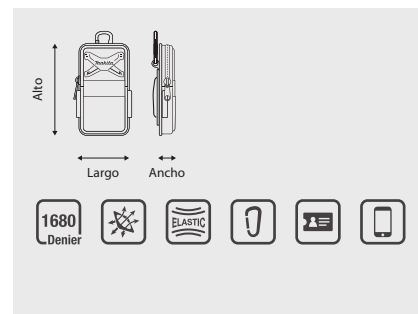

Medidas (L x An x Al)	Peso (Kg)	Capacidad (L)	Unds.	Código	EAN	P.V.P (€)
90 x 40 x 165 mm	0,12	0,18	1	E-05583	0088381567091	19,55



- 1 Logotipo de Makita visible en un moderno diseño de goma.
- 2 Bolsillos en la parte delantera para tarjetas de visita.
- 3 Bolsillos elásticos muy prácticos.
- 4 Alojamientos elásticos para accesorios en los laterales.
- 5 Cierre con cremallera para guardar el teléfono de forma segura.
- 6 Tirador de cremallera de gran durabilidad y resistencia.
- 7 Moderno diseño de goma de Makita.
- 8 Mosquetón para enganchar rápidamente a la presilla del pantalón o cinturón.
- 9 Alojamiento para gancho detrás del soporte de la funda.
- 10 Útil alojamiento elástico para bolígrafo o destornillador.



Bolsillo interno para proteger los objetos de valor.

Herramientas no incluidas

Funda smartphone XL

- Protege tu smartphone ante posibles caídas.
- Ideal para almacenar teléfonos grandes o pequeños.
- Con 2 bolsillos externos y 2 cintas elásticas para bolígrafos; además de un bolsillo especial para tarjetas en el interior.
- Más grande que el modelo E-05583 (de 148mm a 172mm de alto).
- Con una pinza y un mosquetón para engancharse a cinturones y gran variedad de anillas.
- Estructura de tres capas que le da resistencia a las condiciones climáticas de exteriores.

STRAP/BELT SYSTEM

ELASTIC LOOPS

LOOP-CLIP SOLUTION

3 LAYERS



La pinza incorporada en la parte posterior hace ideal el encanche en cinturones.

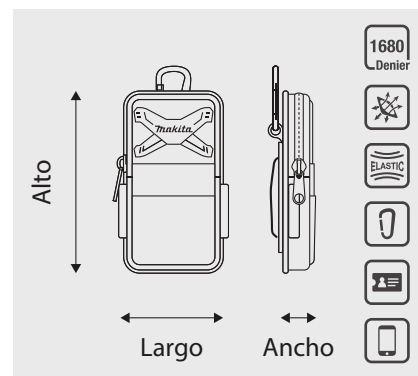

- 1 Mayor tamaño que modelos anteriores
- 2 Cintas para almacenar bolígrafos
- 3 2 bolsillos frontales.
- 4 Mosquetón.
- 5 Pinza trasera.
- 6 Estructura de tres capas que le da resistencia a las condiciones climáticas de exteriores.

Medidas (L x An x Al)	Peso (Kg)	Capacidad (L)	Unds.	Código	EAN	P.V.P (€)
115 x 40 x 200mm	-	-	1	E-12980	0088381589963	21,00



Bolsillo interno para proteger los objetos de valor.

Nevera

- Hecho de poliéster 1680D resistente.
- Cómodo asa de transporte.
- Perfecto para la construcción, la oficina o un picnic familiar.
- Protege los alimentos contra el polvo y los escombros de la obra.
- Su construcción resistente evita fugas.
- La bolsa es espaciosa y puede guardar el almuerzo para el trabajo de todo el día.



3 LAYERS

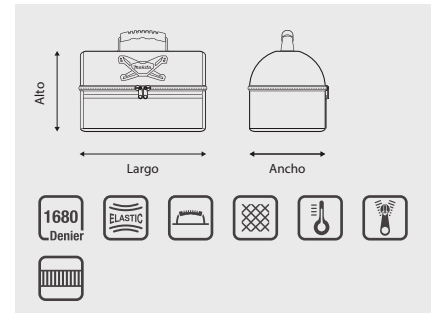

- 1 Práctica red en la parte delantera a modo bolsillo exterior.
- 2 Cremallera para facilitar la apertura.
- 3 Su forma ergonómica mantiene la bolsa estable en todo momento.
- 4 Forro de papel de aluminio de fácil limpieza.
- 5 Asa de goma para un transporte cómodo.

Medidas (L x An x Al)	Peso (Kg)	Capacidad (L)	Unds.	Código	EAN	P.V.P (€)
330 x 180 x 210 mm	0,45	7,5	1	E-05614	0088381567121	33,00



Contenido no incluidas

Chaleco portaherramientas

- Una alternativa al portaherramientas tradicional.
- Libera las manos para moverse con seguridad en escaleras, techos, andamios, etc.
- Dispone de múltiples bolsillos exteriores para una organización perfecta.
- Talla única con ajuste.
- Construcción ligera para la comodidad del usuario.
- Se puede llevar sobre una camiseta, sudadera o chaqueta.

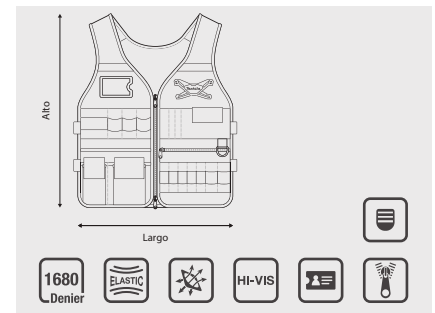

- 1 Cintas ajustables a los lados para según la talla.
- 2 Tira reflectante para mayor seguridad durante el trabajo.
- 3 Plástico transparente para tarjeta de identidad o crédito.
- 4 Los alojamientos elásticos mantienen sus herramientas fijas.
- 5 Bolsillo estrecho con solapa para un almacenamiento seguro.
- 6 Bolsillo ancho con solapa con cierre de seguridad para guardar con seguridad objetos de valor.
- 7 Moderno diseño de goma.
- 8 Bolsillo con cremallera.
- 9 Alojamientos elásticos para bolígrafos, lápices o cualquier tipo de objetos.
- 10 Cierre elástico para el teléfono móvil.

Medidas (L x An x Al)	Peso (Kg)	Capacidad (L)	Unds.	Código	EAN	P.V.P (€)
510 x 640 mm	0,81	-	1	E-05636	0088381567145	72,00



Herramientas no incluidas

Fundas para guías de carril

- Diseñadas para sostener hasta 2 guías de carril, conectores y soportes.
- La funda se adapta a las guías de carril y las protege de rasguños y golpes durante el transporte y almacenamiento.
- Correa de gancho ajustable, bolsillo frontal con cremallera, bolsillos internos para inmovilizar los carriles guía más cortos.
- Duradera y liviana con forro de espuma para protección extra.
- Con asa ergonómica para su transporte y correa para hombro.

STRAP/BELT SYSTEM

3 LAYERS



Bolsillo frontal para almacenar dos sargentos.

Sistema de correa de gancho ajustable para mayor confort.

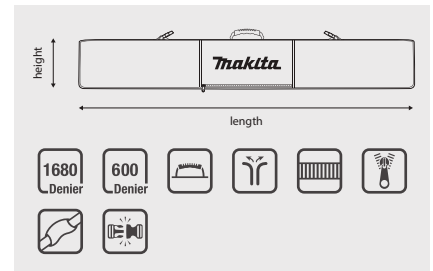

- 1 Bolsillos internos para inmovilizar los carriles guía más cortos.
- 2 Diseñado para almacenar en su interior dos carriles guía.
- 3 Cremallera que recorre la totalidad de la funda para facilitar el almacenaje.
- 4 Cintas y correas ajustables para asegurar los carriles guía.
- 5 Con forro de espuma para protección extra de las guías.

Tamaño de la guía de carril	Peso (Kg)	Capacidad (L)	Unds.	Código	EAN	P.V.P (€)
1 m	1,11	-	1	E-05670	0088381567183	46,00
1,4 / 1,5 m	1,45	-	1	E-05664	0088381567176	53,00
1,9 m	-	-	1	E-10920	0088381581523	83,00
3 m	-	-	1	E-10936	0088381581530	103,00



Cinta de velcro para sujeción



Material acolchado para mayor protección de las guías



Bolsillo externo con cremallera

Rodilleras de alta protección

- Rodilleras de alta protección contra cualquier superficie.
- No resbala, ni marca ni daña las superficies.
- Ideal para trabajos en hormigón, suelos de madera, trabajos de construcción o cualquier trabajo relacionado.
- El diseño antideslizante mantiene las rodilleras en su lugar.
- El acolchado de espuma de alta densidad proporciona la máxima comodidad posible.



Las correas elásticas mantienen las rodilleras en una posición cómoda durante todo el día. Ideal para trabajos en hormigón, suelos de madera y trabajos de construcción.



- 1 La cubierta rígida proporciona un uso prolongado en exteriores
- 2 Cubierta especial para una mayor estabilidad del usuario.
- 3 Las correas elásticas se adaptan a la posición de tu cuerpo.
- 4 Talla única.

Medidas (L x An x Al)	Peso (Kg)	Capacidad (L)	Unds.	Código	EAN	P.V.P (€)
170 x 95 x 240 mm	0,52	-	1	E-05658	0088381567169	48,00



Rodilleras de alta protección

Rodilleras flexibles

- El material suave y antideslizante garantiza una gran durabilidad.
- Protege las rodillas.
- No resbala, ni marca, ni daña las superficies.
- Las cintas flexibles mantienen las rodilleras en una posición cómoda durante todo el día.
- Perfecto para pavimentos y alicatados de todo tipo, en garajes, jardines y obras.



Las cintas flexibles y elásticas mantienen las rodillas en su lugar.

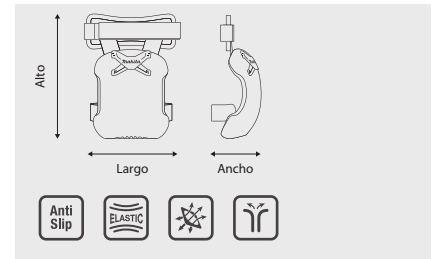

- 1 Hecho de material antideslizante de calidad superior.
- 2 Forro de malla transpirable.
- 3 Las cintas elásticas se adaptan a la posición del cuerpo.
- 4 Talla única.
- 5 Correas de banda elástica con gancho.

Medidas (L x An x Al)	Peso (Kg)	Capacidad (L)	Unds.	Código	EAN	P.V.P (€)
170 x 30 x 240 mm	0,28	-	1	E-05642	0088381567152	32,00



Rodilleras de protección

Baterías, cargadores y compatibilidad de carga



36V
Cargador rápido

BL3626	194873-2	DC36RA	194863-5
P.V.P	278 €	Tiempo de carga	22 min
		P.V.P	184 €

36V
Cargador normal

BL3622A	195410-5	DC36WA	195471-5
P.V.P	190 €	Tiempo de carga	60 min
		P.V.P	95 €

Ni - MH

24V
Ni-MH

DC24SC 194164-1 **167€**

3,1 Ah **268€**
BH2433 193739-3

60 min.



12V
Ni-MH

DC24SC 194164-1 **167€**

3,1 Ah **158€**
BH1233C 193930-3

30 min.

DC18RC 195584-2 **112€**

22 min.

DC18SD 194533-6 **76€**

DC18SE Automóvil 194622-7 **113€**

70 min.

9,6V
Ni-MH

DC24SC 194164-1 **167€**

3,1 Ah **144€**
BH9033C 193636-3

30 min.

DC18RC 195584-2 **112€**

30 min.

DC18SD 194533-6 **76€**

DC18SE Automóvil 194622-7 **113€**

70 min.

1,8 Ah **134€**
BH9020 193631-3

20 min.

15 min.

40 min.

Ni - MH

18V

DC1804 193827-6 **76€**

2,8 Ah **150€**
1835 193061-8

70 min.

DC1822 Automóvil 193439-5 **106€**

70 min.

DC1414 193864-0 **62€**

14,4V

2,8 Ah **115€**
1435 193060-0

70 min.

70 min.

70 min.

18V

2,8 Ah **99€**
1235 193059-5

70 min.

70 min.

70 min.

Maletines



Maletines Makpac apilables.

• Ofrecemos un amplio catálogo para transportar sus equipos de trabajo con las mejores condiciones. Además, podrá expandir sus equipos de trabajo de forma sistemática.



- Con el almacenamiento MakPac, usted puede en cualquier momento modificar las diferentes formas de almacenamiento, combinarlos por separado y transportar sus dispositivos adicionales.
- En su almacén, las posibilidades son ilimitadas.
- El número de maletines que pueden ser apilados, de hecho, es ilimitada.



• Tiradores fuertes y retráctiles hacen que el transporte y el almacenamiento se haga de una forma correcta.

Cuatro tamaños diferentes.

- Dispone de cuatro tamaños diferentes de maletines.
- También puede optar por un plástico específico para almacenar su herramienta correctamente.
- Los maletines MAKPAC son apilables, pueden estar unidos o separados por los cuatro clips de bloqueo manual.
- Una vez que se unen entre sí, se pueden coger con una mano para ser transportados.
- Tiradores fuertes y retráctiles hacen que el transporte y el almacenamiento se haga de una forma correcta.



Tipo 1



Tipo 2



Tipo 3



Tipo 4

Maletines Makpac con cajones

• Nuevos maletines Makpac con cajones para accesorios



P-84311



P-84333



P-84327

- Maletines Makpac con cajones, para mayor comodidad y organización. Distribuye fácilmente tornillos, tacos y otros accesorios.
- Posibilidad de unir fácilmente los diferentes productos Makpac.

Descripción	Unds.	Código	EAN	P.V.P. (€)
4 Cajones. 295 x 395 x 210 mm	1	P-84311	0088381580786	182,00
6 Cajones. 295 x 395 x 210 mm	1	P-84333	0088381580809	208,00
12 Cajones. 295 x 395 x 210 mm	1	P-84327	0088381580793	216,00

Set de cajas para maletines Makpac



Descripción	Unds.	Código	EAN	P.V.P. (€)
Set de cajas	1	P-84171	-	14,40

Nevera Makpac

¡Estupenda para mantener frías las bebidas en el lugar de trabajo!

- Con un grosor de 20mm de poliestireno, y tiras de sellado en la junta entre la tapa y la caja.

18L



500mL x 20 2L x 4

Dimensiones	Maletín	Unds.	Código	EAN	P.V.P. (€)
295 x 395 x 315mm	Tipo 4	1	198253-4	0088381476607	120,00

Carro de transporte



Descripción	Unds.	Código	EAN	P.V.P. (€)
Carro de transporte Admite hasta 100 kg de carga	1	P-83886	0088381468411	120,00

Trolley con ruedas



Maletín Makpac no incluido

Descripción	Unds.	Código	EAN	P.V.P. (€)
Trolley con ruedas Admite hasta 25 kg de carga.	1	TR00000001	0088381468190	213,00

Plástico interior clasificador



Maletín Makpac no incluido

Descripción	Unds.	Código	EAN	P.V.P. (€)
Clasificador con diferentes compartimentos	1	P-83668	0088381463805	10,80

Plástico interior clasificador de colores

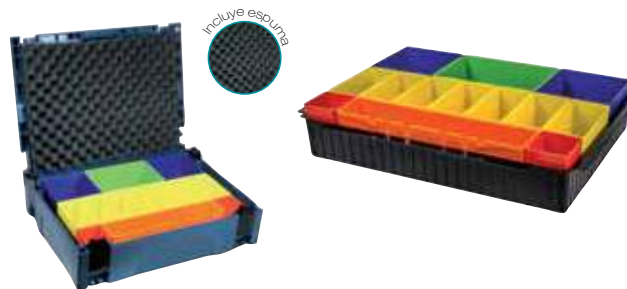

Maletín Makpac no incluido

Descripción	Unds.	Código	EAN	P.V.P. (€)
Clasificador con diferentes compartimentos	1	P-83652	0088381463799	32,00

Separador de espuma

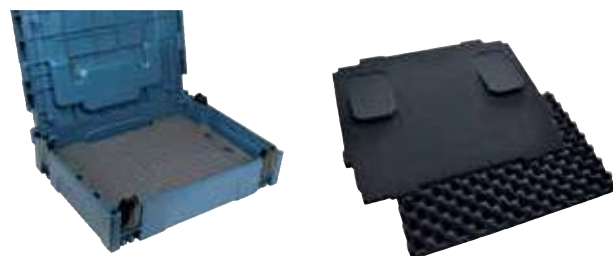

Maletín Makpac no incluido

P-84268

Descripción	Unds.	Código	EAN	P.V.P. (€)
Separador de espuma válido para todos los maletines Makpac	1	P-83705	0088381463843	22,00
Espuma 20mm universal mackpac	1	P-84268	-	16,65
Espuma 40mm universal mackpac	1	P-84274	-	19,25

Caja herramientas makpac



Descripción	Unds.	Código	EAN	P.V.P. (€)
Práctica caja de herramientas con múltiples compartimentos.	1	P-84137	0088381524865	89,00

Plásticos interiores y maletines MAKPAC

Tipo 1



Medidas	Unds.	Código	EAN	P.V.P. (€)
39,5 x 29,5 x 10,5 cm	1	821549-5	0088381432986	31,00

Tipo 2



Medidas	Unds.	Código	EAN	P.V.P. (€)
39,5 x 29,5 x 15,5 cm	1	821550-0	0088381430128	34,00

PLÁSTICOS INTERIORES

Makpac	Modelo (Herramienta)	Unds.	Código	EAN	P.V.P. (€)
821549-5	4326 4328 4326 4329 4350CT 4350FCT 4351FCT JV0600	1	837803-7	0088381436090	7,70
	DA330D	1	837695-4	0088381436083	9,55
	DF030D DF330D HP330D TD090D TW100D	1	837866-3	0088381525954	8,20
	DF031D DF032D DF033D DF331D DF332D DF333D HP331D HP332D HP333D TD110D TD111D	1	838312-9	0088381526166	6,55
	DP3002 DP3003 DP4001 DP4002 DP4003 DP4001 HP2051 HP2071	1	838039-1	0088381441452	8,15
	JR100D	1	837664-5	0088381436052	8,20
	6904V 6952 TW0200	1	837869-7	0088381525978	7,95
	HR1841	1	839214-2	-	5,20
	JV103	1	839186-1	0088381526234	5,15



PLÁSTICOS INTERIORES

Makpac	Modelo (Herramienta)	Unds.	Código	EAN	P.V.P. (€)
821550-0	DBO180	1	837809-5	0088381437349	7,70
	DBS180	1	835P86-9	-	4,20
	DDA350	1	838040-6	0088381441704	7,35
	DDF343 DDF441 DDF446 DDF448 DDF451 DDF453 DDF456 DDF459 DDF480 DDF482 DDF484 DHP343 DHP441 DHP446 DHP448 DHP451 DHP453 DHP456 DHP459 DHP480 DHP481 DHP482 DHP484	1	837916-4	0088381441438	9,05
	DFS250 DFS251 DFS451 DFS452 FS2300 FS2500 FS2700 FS4200 FS6300	1	837805-3	0088381436250	7,70
	DGD800	1	837806-1	0088381436267	7,70
	DJV180 DJV182	1	837639-4	0088381436120	11,35
	DJS161	1	837636-0	0088381436113	7,10
	BO4900V BO4901	1	837675-0	0088381436212	8,40
	BST221 DPT351	1	837640-9	0088381436137	9,30
	DFN350	1	835B51-4	0088381568777	3,85
	DDF083 DDF483 DHP483 DTD129 DTD134 DTD146 DTD147 DTD148 DTD152 DTD153 DTD154 DTD155 DTD170 DTD171 DTP140 DTP141 DTW250 DTW251 DTW281 DTW285	1	837670-0	0088381436182	12,10
	DTW300 DTW301	1	835L10-8	-	3,55
	DTL061	1	837644-1	0088381436144	8,45
	GA4540 GA4540C GA5040 GA5040C SA5040C	1	837672-6	0088381436199	4,35
	HR2300 HR2600 HR2610 HR2610T HR2611FT	1	837651-4	0088381436151	8,10
	HS300D	1	837662-9	0088381436175	15,20
	JN3201 JS3201	1	837630-2	0088381430142	8,45
	RP0900	1	837646-7	0088381525916	8,15
	RP0910 RP1110C	1	837660-3	0088381436168	8,50
	TM3000C TM3010C	1	837673-4	0088381436205	8,15
	TW0350	1	837870-2	0088381525985	7,55
	TW004G TW005G	1	835R29-3	-	3,85
	BO5030 BO5031 BO5040 BO5041	1	837874-4	0088381526029	10,60
	6906	1	838024-4	-	10,55
	9046	1	838025-2	-	10,60
	3709 3710	1	837674-2	0088381525923	8,75
	HR166D	1	838683-4	-	6,20
	DJR183	1	837897-2	0088381447195	5,45
	HR140	1	839245-1	0088381526258	4,95
	DRV150Z	1	835A34-8	-	3,80

Plásticos interiores y maletines MAKPAC

Tipo 3



Medidas	Unds.	Código	EAN	P.V.P. (€)
39,5 x 29,5 x 21,5 cm	1	821551-8	0088381432993	37,00

Tipo 4



Medidas	Unds.	Código	EAN	P.V.P. (€)
39,5 x 29,5 x 31,5 cm	1	821552-6	0088381433006	48,00

PLÁSTICOS INTERIORES

Makpac	Modelo (Herramienta)	Unds.	Código	EAN	P.V.P. (€)
821551-8	9403	1	837652-2	0088381436359	8,25
	9404	1	837653-0	0088381436366	8,20
	9911 9910	1	837658-0	0088381436397	7,70
	BO6030	1	837654-8	0088381436373	8,70
	BO6040	1	837655-6	0088381436380	8,45
	DBN500	1	838023-6	0088381453967	7,35
	DSS501 DCS550	1	837628-9	0088381436274	8,50
	DFR550Z	1	837631-0	0088381447201	7,65
	DGA504 DGA508 DGA454 DGA458 DGA461 DGA467 DGA511 DGA517 DTD171 DTD171	1	838175-3	0088381453981	10,05
	DGA452	1	837632-8	0088381436281	8,15
	DHR165	1	838109-6	0088381453998	8,50
	DHR202	1	837634-4	0088381436304	9,00
	DHS680	1	838182-6	0088381454018	10,15
	DKP180	1	837808-7	0088381436434	7,70
	DPJ180	1	837648-3	0088381436342	7,70
	DSS610	1	837642-5	0088381436328	9,00
	DTM50 DTM51	1	837671-8	0088381436427	8,10
	DTW450 DTW1001 DTW1002	1	837645-9	0088381436335	8,25
	HP001G DF001G	1	835F93-2	-	2,95
	KP0800 KP0810 KP0810C	1	837659-8	0088381436403	7,70
	N9741	1	838026-0	-	8,75
	PJ7000	1	837661-1	0088381436410	11,45
	DHR171	1	839387-1	0088381535588	5,25
	DPT353	1	839128-5	0088381535601	8,45
	DLX2221	1	837864-7	0088381441216	5,45
	DJN161	1	837678-4	0088381436229	12,00
	DJR188	1	839458-4	0088381526319	7,30
	DJV181	1	837789-5	0088381441414	6,95
	BO6050J	1	838246-6	0088381526142	5,50
	DHS661Z	1	839752-4	-	5,15
	HS6601	1	838314-5	-	4,90
	DCS553	1	839751-6	0088381546492	4,90
	TD001G	1	835F94-0	-	3,05
TW001G TW007G TW008G	1	835K85-1	-	3,80	

PLÁSTICOS INTERIORES

Makpac	Modelo (Herramienta)	Unds.	Código	EAN	P.V.P. (€)
821552-6	5008MG 5604R 5704R	1	837657-2	0088381436489	9,60
	CA5000	1	838390-9	0088381526197	9,90
	DHR242 DHR243	1	837649-1	0088381535595	8,20
	DHR262 DHR262T	1	837650-6	0088381436472	8,50
	DHR263 DHR264	1	837988-9	0088381454001	9,30
	DHS710	1	837861-3	0088381441445	17,45
	DHK180	1	835D35-4	0088381574501	4,35
	HS6101 HS7101	1	837807-9	0088381436502	8,00
	RP1800 RP2300FC	1	837647-5	0088381436465	8,20
	RT0700C	1	837247-1	0088381436441	8,20
	SP6000	1	837945-7	0088381437356	7,70
	SG1251	1	838111-9	0088381526135	8,25
	BO5030 BO5031 BO5040 BO5041	1	837247-1	0088381436441	8,20
	DHR280 DHR281 DHR282 DHR283	1	839559-8	0088381526333	4,30
	CC301	1	838315-3	0088381526180	6,80
	DHR182	1	839891-0	-	5,20
	DBN600	1	839523-9	-	4,35
	GA005G GA008G GA013G GA016G GA022G GA023G GA026G GA028G GA029G GA032G	1	835E79-0	-	3,00
	KITS BATERÍAS 4,0 Ah 5,0 Ah 6,0 Ah	1	839205-3	0088381436342	5,20
	HR001G HR002G HR003G HR004G	1	835C84-5	-	3,00
	HS004G	1	835K82-7	-	3,80
	HS7601	1	838108-8	-	5,65

Cierre maletín Makpac



Descripción	Unds.	Código	EAN	P.V.P. (€)
Cierre maletín Makpac	1	453974-8	0088381430135	0,60

Modelo	Descripción	Unds.	Código	EAN	P.V.P. (€)
1100	Metálico	1	181790-5	008838118705	99,00
4326	Plástico	1	824572-9	0088381151627	11,85
4327	Plástico	1	824572-9	0088381151627	11,85
4328	Plástico	1	824572-9	0088381151627	11,85
4329	Plástico	1	824572-9	0088381151627	11,85
6807	Plástico	1	824890-5	3240890391902	15,45
6842	Plástico	1	824808-6	0088381347204	34,00
6844	Plástico	1	824808-6	0088381347204	34,00
2107F	Plástico	1	824728-4	0088381197700	45,00
2107FX	Plástico	1	824728-4	0088381197700	45,00
4350CT	Plástico	1	824809-4	0088381345729	23,00
4350T	Plástico	1	824809-4	0088381345729	23,00
4351CT	Plástico	1	824809-4	0088381345729	23,00
5603R	Plástico	1	824555-9	0088381189422	46,00
5604R	Plástico	1	824555-9	0088381189422	46,00
5903R	Plástico	1	193196-5	0088381189385	58,00
6019D	Plástico	1	824723-4	0088381200455	17,00
6096D	Plástico	1	824723-4	0088381200455	17,00
6207DW	Plástico	1	183763-4	0088381139595	23,00
6260D (3baterías)	Plástico	1	824652-1	0088381196949	9,80
6260D (linterna)	Plástico	1	824581-8	0088381156790	12,35
6261D (3baterías)	Plástico	1	824852-3	0088381350631	14,15
6270D (3baterías)	Plástico	1	824652-1	0088381196949	9,80
6270D (linterna)	Plástico	1	824581-8	0088381156790	12,35
6271D (3baterías)	Plástico	1	824852-3	0088381350631	14,15
6280D (3baterías)	Plástico	1	824652-1	0088381196949	9,80
6280D (Linterna)	Plástico	1	824581-8	0088381156790	12,35
6281D (3baterías)	Plástico	1	824852-3	0088381350631	14,15
6317D	Plástico	1	183763-4	0088381139595	23,00
6337D	Plástico	1	183763-4	0088381139595	23,00
6347D	Plástico	1	183763-4	0088381139595	23,00
6391D (3baterías)	Plástico	1	824852-3	0088381350631	14,15
6904V	Plástico	1	824698-7	0088381183789	28,00
6905B	Plástico	1	824698-7	0088381183789	28,00
6905H	Plástico	1	824698-7	0088381183789	28,00
6918FD	Plástico	1	824635-1	0088381161145	10,85
6934FD	Plástico	1	824635-1	0088381161145	10,85
6935FD	Plástico	1	824635-1	0088381161145	10,85
6936FD	Plástico	1	824635-1	0088381161145	10,85
6980FD	Plástico	1	824635-1	0088381161145	10,85
8270D	Plástico	1	824635-1	0088381161145	10,85
8280D	Plástico	1	824635-1	0088381161145	10,85
9554NB	Metálico	1	823256-6	-	24,00
9555NB	Metálico	1	823256-6	-	24,00
9557NB	Metálico	1	823256-6	-	24,00
9558NB	Metálico	1	823256-6	-	24,00
AF505	Plástico	1	HY00000090	0088381335218	19,55
BFR440	Plástico	1	824756-9	0088381341981	22,00
BGA452	Plástico	1	824767-4	0088381289702	19,55
BHR162	Plástico	1	824863-8	0088381351010	53,00
BHR200SJEP	Plástico	1	824690-3	-	36,00
BHR202	Plástico	1	141642-2	-	24,00

Modelo	Descripción	Unds.	Código	EAN	P.V.P. (€)
BJR181	Plástico	1	824760-8	0088381341998	23,00
BO4556	Plástico	1	824806-0	0088381346092	13,55
BO4565	Plástico	1	824806-0	0088381346092	13,55
BO5020	Plástico	1	183782-0	0088381189262	23,00
BO5021	Plástico	1	183782-0	0088381189262	23,00
BO5030	Plástico	1	183782-0	0088381189262	23,00
BO5031	Plástico	1	183782-0	0088381189262	23,00
BSS610	Plástico	1	824757-7	0088381252898	30,00
BTW200	Plástico	1	824593-1	0088381158084	35,00
BUC122	Plástico	1	824820-6	3240890258571	47,00
DA400LR	Plástico	1	824646-6	0088381171052	44,00
DBM080	Metálico	1	P-45135	0088381975247	47,00
DBN500	Metálico	1	821604-3	-	56,00
DF010D	Plástico	1	158775-6	3240890276278	11,55
DF030D	Plástico	1	824842-6	3240890276261	11,45
DF330D	Plástico	1	824842-6	3240890276261	11,45
DF347D	Plástico	1	824981-2	0088381401517	18,60
DF457D	Plástico	1	824981-2	0088381401517	18,60
DP4011	Plástico	1	824695-3	0088381184342	15,40
FS2300	Plástico	1	824890-5	3240890391902	15,45
FS2500	Plástico	1	824890-5	3240890391902	15,45
FS2700	Plástico	1	824890-5	3240890391902	15,45
FS4200	Plástico	1	824890-5	3240890391902	15,45
FS6300R	Plástico	1	824890-5	3240890391902	15,45
GA038G	Plástico	1	821841-9	-	52,00
GA7020R	Plástico	1	824958-7	0088381371438	29,00
GA7030R	Plástico	1	824958-7	0088381371438	29,00
GA7040R	Plástico	1	824958-7	0088381371438	29,00
GA9020R	Plástico	1	824958-7	0088381371438	29,00
GA9030R	Plástico	1	824958-7	0088381371438	29,00
GA9040R	Plástico	1	824958-7	0088381371438	29,00
GF600SE	-	-	824990-1	0088381425148	58,00
GN900SE	Plástico	1	824875-1	0088381354509	50,00
HG5002	Plástico	1	HG130442	3240890345578	22,00
HG5012	Plástico	1	HG130442	3240890345578	22,00
HG550V	Plástico	1	HG130442	3240890345578	22,00
HG551V	Plástico	1	HG130442	3240890345578	22,00
HG651C	Plástico	1	HG130442	3240890345578	22,00
HK0500	Plástico	1	824523-2	0088381151849	40,00
HK1810	Metálico	1	150640-5	0088381152426	35,00
HK1820	Plástico	1	824789-4	0088381346108	17,75
HM0860C	Plástico	1	824708-0	0088381187725	39,00
HM0870C	Plástico	1	824905-8	-	71,00
HM0871C	Plástico	1	824904-0	0088381361743	74,00
HM1101C	Plástico	1	140561-9	0088381367639	132,00
HM1111C	Plástico	1	140561-9	0088381367639	132,00
HM1200K	Plástico	1	150583-1	0088381152402	47,00
HM1202C	Plástico	1	824564-8	0088381154536	69,00
HM1203C	Plástico	1	824908-2	0088381359504	102,00
HM1213C	Plástico	1	824908-2	0088381359504	102,00
HM1214C	Plástico	1	824882-4	0088381359788	146,00
HM1303	Metálico	1	182851-4	0088381155618	148,00

Modelo	Descripción	Unds.	Código	EAN	P.V.P. (€)
HM1304B	Metálico	1	183598-3	0088381183796	105,00
HM1307C	Plástico	1	824898-9	-	142,00
HM1317C	Plástico	1	824898-9	-	142,00
HM1317CB	Plástico	1	824898-9	-	142,00
HP1620	Plástico	1	824724-2	0088381193887	18,00
HP1621	Plástico	1	824724-2	0088381193887	18,00
HP1631	Plástico	1	824811-7	0088381351140	17,80
HP1640	Plástico	1	824811-7	0088381351140	17,80
HP1641	Plástico	1	824811-7	0088381351140	17,80
HP2050	Plástico	1	824695-3	3240890275165	15,40
HP2051	Plástico	1	824695-3	3240890275165	15,40
HP2070	Plástico	1	824695-3	3240890275165	15,40
HP2071	Plástico	1	824695-3	3240890275165	15,40
HP330D	Plástico	1	824842-6	3240890276261	11,45
HP347D	Plástico	1	824981-2	0088381401517	18,60
HP457D	Plástico	1	824981-2	0088381401517	18,60
HR005G	Plástico	1	821837-0	-	43,00
HR160D	Plástico	1	824550-9	0088381157612	20,10
HR1830	Plástico	1	824695-3	3240890275165	15,40
HR2020	Plástico	1	824695-3	3240890275165	15,40
HR2230	Plástico	1	824799-1	0088381346849	25,00
HR2440	Plástico	1	824695-3	3240890275165	15,40
HR2450	Plástico	1	824695-3	3240890275165	15,40
HR2460	Plástico	1	824799-1	0088381346849	25,00
HR2470	Plástico	1	824799-1	0088381346849	25,00
HR2800	Plástico	1	824789-4	0088381346108	17,75
HR2810	Plástico	1	824789-4	0088381346108	17,75
HR2811	Plástico	1	824789-4	0088381346108	17,75
HR3200C	Plástico	1	824819-1	3240890266422	55,00
HR3210C	Plástico	1	824825-6	0088381349727	64,00
HR3540C	Plástico	1	824819-1	3240890266422	55,00
HR3541FC	Plástico	1	824825-6	0088381349727	64,00
HR4013C	Plástico	1	196278-2	0088381462976	98,00
HR4500C	Plástico	1	824607-6	0088381160070	63,00
HR4501C	Plástico	1	158274-8	0088381369510	76,00
HR5000	Plástico	1	150589-9	0088381146661	58,00
HR5001C	Plástico	1	824519-3	0088381152952	64,00
HR5201C	Plástico	1	158274-8	3240890306630	76,00
JR001G	Plástico	1	821796-8	0088381579797	37,00
JR3060T	Plástico	1	821621-3	-	23,00
JR3070CT	Plástico	1	821621-3	-	23,00
JV0600K	Plástico	1	824998-5	0088381401487	21,00
KP0800	Plástico	1	824892-1	0088381361408	15,40
PC1100	Metálico	1	181789-0	0088381116213	70,00
PC5001C	Metálico	1	140073-2	0088381358651	72,00
SG150	Metálico	1	B50856	3240890267061	64,00
TD090D	Plástico	1	824842-6	3240890276261	11,45
TW0200	Plástico	1	824703-0	0088381185424	15,10
TW0350	Plástico	1	824702-2	0088381185837	20,05
TW1000	Plástico	1	824737-3	0088381200042	56,00
UC120DWAE	Plástico	1	824491-9	0088381152747	37,00
JV101	Plástico	1	821691-2	-	21,00

Modelo	Descripción	Unds.	Código	EAN	P.V.P. (€)
HR4001	Plástico	1	196183-3	-	93,00
HR4011C	Plástico	1	196185-9	-	99,00
DTM51	Plástico	1	821608-5	-	23,00
BHP458	Plástico	1	143603-8	-	36,00
HS7101	Plástico	1	141736-3	-	57,00
TD110D	Plástico	1	821661-1	-	16,70
DJR187	Plástico	1	821620-5	0088381572385	29,00
DJR181	Plástico	1	141354-7	-	29,00
HS301D	Plástico	1	821663-7	-	21,00
DCG180	Plástico	1	821568-1	0088381437516	63,00
DGA900	Plástico	1	821717-0	0088381536172	58,00
DGA511	Plástico	1	821734-0	-	36,00
CG100	Plástico	1	821710-4	0088381585927	32,00
DJR360	Plástico	1	821670-0	0088381524209	51,00
9069K1	Plástico	1	824707-2	-	15,45
BHR242	Plástico	1	141401-4	0088381432764	30,00

Escobillas (por modelos de máquina)

1		6319D		BPJ180		DTW450	441	HP1631K	419	LF1016F	
1100	100	6337D		BSS501	430	F		HP2010N	106	LH1040F	153
1902	51	6339D	430	BSS610	441	FS2300		HP2033		LH200FL	
1806B	153	6347D		BTD130F		FS2500		HP2050		LS0714F	303
1902K		6349D		BTD140	440	FS2700	419	HP2051		LS0815FL	JM23500117
1923B	51	6501X	70	BTD200	441	FS4200		HP2070	419	LS1013F	
1923H	132	6797F	424	BTP130		FS6300R		HP2071		LS1013FL	
2		6805BV	64	BTP140	440	G		HR1830		LS1013L	
2012NB	153	6824N		BTS130	440	GA4530		HR2020		LS1016FL	
2107FK		6825R	419	BTW200	441	GA5030		HR2230	325	LS1018L	
2107FKX	303	6826N		BTW250		GA4534		HR2300		LS1040F	153
2414B		6904V	415	BTV251	440	GA5034		HR2410		LS1214F	
2414EN	203	6905B	65	BTW450	441	GA4540C	318*	HR2432		LS1214L	
2414NB		6905H	415	BUUC122	430	GA4540Z	325	HR2440	419	LS1216F	
2704	153	6918FD		D		GA5021C	253	HR2450		LS1216FL	
3		6932FD		DA3000R	65	GA5040C	318*	HR2450T		LS1440	
3612	203	6934FD		DA3010F	419	GA5040Z	325	HR2460		M	
3620	106	6935FD	434	DA3011F		GA6021C	253	HR2460F		MLS100	
3706	64	6936FD		DA4000LR	303	GA6040C	318*	HR2470	325	MLT100	JM23000123
3709		6980FD		DA4031		GA7010C		HR2470F		N	
3710	411	7		DA6301	100	GA7012C	204*	HR2470FT		N4105KB	
3901		7104L	153	DBM130		GA7020S		HR2510	105*	N9741	100
3601B	153	8		DBM131	EE80700019	GA7020R		HR2600		NPC1100	
3612C	203	8414D		DBM230		GA7030S		HR2610		P	
3707FC	411	8434D	430	DCS550	430	GA7030R		HR2610T	325	PC5001C	253
4		8444D		DDA340		GA7040S		HR2611FT		PJ7000C	459
440	80051B5X	9		DDF440		GA7040R		HR262D	442	PV7000C	303
443	W26774	906	64	DDF441		GA7050		HR262TD		PW5000CH	318*
445X	80051B5X	9031		DDF442		GA7050R		HR2800		R	
446L		9032	411	DDF450		GA9010C	204*	HR2810	325	RP0900	106
447L	W49625	9046	419	DDF451		GA9012C		HR2810T		RP0910	
4131	303	9402	153	DDF452		GA9020S		HR2811FT		RP1100C	303
4326		9403		DDF458	440	GA9020R		HR3000C	327*	RP1800	203
4327		9404	303	DFR440		GA9030S		HR3200C		RP2300FC	411
4328	64	9903		DFR550		GA9030R		HR3210C		RT0700C	
4329		9910	411	DFR750		GA9040S		HR3210FCT	350*	S	
4402		9911		DFS440		GA9040R		HR3540C		SA5040C	318*
4403	411	9920		DFS450		GA9050		HR3541FC		SA7000C	204*
4101RH	303	9015B	303	DFS451		GA9050R		HR4000C	327*	SC161D	430
4112HS	204*	9016B		DGA452	430	GD0600		HR4001C		SG1250	318*
4114S		9049S		DGD800		GD0601	325	HR4003C		SG1251J	
4157KB	153	9059S		DHP440		GD0602		HR4011C	350*	SG150	B45872
4329K	64	9077S	204*	DHP441		GD0800C		HR4013C		SL7000	MO1401045
4331D		9079S		DHP442		GD0801C	318*	HR4500C	155*	SP6000	303
4333D	430	9218SB	100	DHP450	440	GD0810C		HR4501C		SR2300	155*
4334D	441	9227CB	303	DHP451		GD0811C		HR4511C	171	T	
4340CT		9554NB		DHP452		GSS000	204*	HR5000	155*	TD0101F	411
4350CT		9555NB		DHP458		GS6000		HR5001C		TM3000C	
4350FCT		9557NB	325	DHP460		GV5010	64	HR5201C	171	TM3010C	459
4350T	419	9558NB		DHR162	430	GV7000C	303	HR5202C	175	TW0200	411
4351CT		9558PBY		DHR200		H		HR5211C	171	TW0350	
4351FCT		9561CH		DHR202	441	HB500	EIB106C	HR5212C	175	TW1000	153
5		9562C		DHR261		HK0500	113	HS6100		U	
5008MG	153	9562CH	318*	DHR262	442	HK1810	105*	HS7100	174	UB1101	303
5017RKB	303	9562CVH		DJN161	430	HK1820	350*	J		UC3530A	957805410
5103R		9564C		DJR181		HM0810B		JN1601	411	UC4020A	132
5104S	203	9564H	325	DJR182	441	HM0810T	105*	JN3200	100	UC4030A	957805410
5143R		9565CV	318*	DJR240		HM0830T		JN3201	303	UT120	EE80700013
5603R		9565CVL		DJV140	430	HM0860C	327*	JR1201	419	UT121	EE80700032
5604R	303	9565H	325	DJY180		HM0870C		JR1000FT	441	SG150	B45872
5704R		9565PCV		DDF446		HM0871C	350*	JR140D		SP6000	303
5705R		9566C		DDF458	440	HM1101C		JR180D		SR2300	155*
5903R	203	9566CV	318*	DFS451		HM1111C	171	JR3050T		T	
6		9566PCV		DGA452	430	HM1200B		JR3060T	303	TM3000C	
6305	303	9924DB	100	DHP456	440	HM1200K	155*	JR3070CT		TM3010C	459
6310		E		DHP458		HM1202C		JS1000	459	TW0200	
6408	419	BLS820	441	DHR202	441	HM1203C		JS1600	65	TW0350	411
6413	64	BO3700	64	DJR181		HM1213C	171	JS1601		TW1000	153
6501	70	BO4556		DJV180	430	HM1214C		JS1602	459	U	
6807		BO4557		DP2010		HM1304	204*	JS1660		UB1101	303
6821		BO4565	419	DP2011		HM1304B		JS1670	65	UC3530A	957805410
6823	419	BO4566		DP3002		HM1307C		JS3200	100	UC4020A	132
6824		BO4900V		DP3003		HM1317C	171	JS3201	303	UC4030A	
6826		BO4901		DP4000	419	HM1317CB		JS8000	419	UH5540	957805410
6827		BO5010		DP4001		HM1400	155*	JV0600	64	UH6540	
6842		BO5020	64	DP4002		HM1801		K		UT120	EE80700013
6844	411	BO5021		DP4003		HM1810	204*	KP0800	411	UT1200	EE80700032
6906	100	BO5030	419	DP4011		HP1620	419	KP0810C	132		
6952	411	BO5031		DS4012	411	HP1621		KP0810S	203		
6013B		BO5040		DP4700	64	HP1631	85	L			
6300-4	51	BO5041	64	DS4010	411	HP1640		LC1230	203		
6305W	303	BO6030	419	DTD146	440	HP1641	419	LF1000	153		
6317D	430	BO6040	318*	DTW251		HP1641K					

Escobillas (por modelo de escobilla)

51	1902	155*	HM1200B	303	4101RH	325	HR2810T	419	DP4003	440	DFR750
	1902K		HM1200K		5017RKB		HR2811FT		DP4011		DFS440
	1923B		HM1202C		5603R		HM0830T		FS2300		DFS450
	6013B		HM1400		5604R		HM0860C		FS2500		DFS451
	6300-4		HR4500C		5704R		HR3000C		FS2700		DHP440
64	3706	171	HR5000	303	5705R	350*	HR4000C	419	FS4200	440	DHP441
	4326		HR5001C		6305		HK1820		FS6300R		DHP442
	4327		SR2300		6305W		HM0870C		HP1620		DHP450
	4328		HM1101C		9403		HM0871C		HP1621		DHP451
	4329		HM1111C		9404		HR3200C		HP1640		DHP452
	4329K		HM1203C		9903		HR3210C		HP1641		DHP458
	6413		HM1213C		9920		HR3210FCT		HP1641K		DDF446
	6805BV		HM1214C		9015B		HR3540C		HP1631K		DDF458
	906		HM1307C		9016B		HR3541FC		HP2033		DFS451
	BO3700		HM1317C		9227CB		HR4001C		HP2050		DHP456
	BO5010		HM1317CB		DA4000LR		HR4003C		HP2051		DHP458
	BO5020		HR4501C		DA4031		HR4011C		HP2070		DTD146
	BO5021		HR4511C		GV7000C		HR4013C		HP2071		DTW251
	BO5040		HR5201C		JN3201				HR1830		4334D
	BO5041		HR5211C		JR3050T				HR2020		BLS820
DP4700	HS6100	JR3060T		HR2410	BSS610						
GV5010	HS7100	JR3070CT		HR2432	BTD200						
JV0600	HS7101	JS3201		HR2440	BTW200						
6905B	HR5202C	LS0714F		HR2450	BTW450						
DA3000R	HR5212C	PV7000C		HR2450T	DHR202						
65	JS1600	175	2414B	303	RP0910	411	6844	424	JR1000FT	441	DJR181
	JS1660		2414EN		RP1100C		6952		JS8000		DJR182
	JS1670		2414NB		SP6000		9031		6797F		DJR240
	6501		3612		UB1101		9032		4331D		DHR202
70	6501X	203	3612C	318*	9561CH	411	9910	430	4333D	442	DJR181
	5103R		5104S		9562CH		9911		6317D		DTW450
85	1100	203	5143R	318*	9562CVH	415	DS4012	430	6319D	459	JR140D
	6906		5903R		9564C		DS4010		6337D		JR180D
	9218SB		5903R		9564C		JN1601		6339D		DHR261
	9924DB		KP312S		9565CV		KP0800		6347D		DHR262
	DA6301		LC1230		9565CVL		RT0700C		6349D		HR262D
	JN3200		RP1800		9565PCV		TD0101F		8414D		HR262TD
	JS3200		RP2300FC		9566C		TW0200		8434D		GA4530
	N4105KB		4112HS		9566CV		TW0350		8444D		GA5030
	N9741		4114S		9566PCV		6904V		BPJ180		GA4534
	NPC1100		9049S		B06040		6905H		BSS501		GA5034
100	HK1810	203	9059S	318*	GA4540C	415	4340CT	430	BUC122	459	JS1000
	HM0810B		9077S		GA5040C		4350CT		DCS550		JS1601
	HM0810T		9079S		GA6040C		4350FCT		DGA452		JS1602
	HR2510		GA7010C		GD0800C		4350T		DGD800		PJ7000C
105*	3620	204*	GA7012C	318*	GD0801C	419	4351CT	434	DHP460	440	TM3000C
	HP2010N		GA7020S		GD0810C		4351FCT		DHR162		TM3010C
	RP0900		GA7020R		GD0811C		6310		DHR200		UC3530A
	HK0500		GA7030S		PW5000CH		6408		DUN161		UC4030A
	1923H		GA7030R		SA5040C		6807		DJV140		440
	KP0810		GA7040S		SG1250		6821		DJV180		445X
	KP0810C		GA7040R		SG1251J		6823		DGA452		SG150
	UC4020A		GA7050		9554NB		6824		DJV180		UT120
	1806B		GA7050R		9555NB		6826		SC161D		DBM130
	2012NB		GA9010C		9557NB		6827		6918FD		DBM131
2704	GA9012C	9558NB	6824N	6932FD	DBM230						
3601B	GA9020S	9558PBY	6825R	6934FD	UT121						
4157KB	GA9020R	9564H	6826N	6935FD	UT1200						
5008MG	GA9030S	9565H	9046	6936FD	HB500						
7104L	GA9030R	GA4540Z	BO4556	6980FD	MLS100						
9402	GA9040S	GA5040Z	BO4557	BTD130F	MLT100						
LF1000	GA9040R	GD0600	BO4565	BTD140	LS0815FL						
LF1016F	GA9050	GD0601	BO4566	BTP130	SL7000						
LH1040F	GA9050R	GD0602	BO4900V	BTP140	443						
LH1200FL	GS5000	HR2230	BO4901F	BTS130	446L						
LS1013F	GS6000	HR2300	BO5030	BTW250	447L						
LS1013FL	HM1304	HR2460	BO5031	BTW251							
LS1013L	HM1304B	HR2460F	BO6030	DDA340							
LS1016FL	HM1801	HR2470	DA3010F	DDF440							
LS1018L	HM1810	HR2470F	DA3011F	DDF441							
LS1040F	SA7000C	HR2470FT	DP2010	DDF442							
LS1214F	GA5021C	HR2600	DP2011	DDF450							
LS1214L	GA6021C	HR2610	DP3002	DDF451							
LS1216F	PC5001C	HR2610T	DP3003	DDF452							
LS1216FL	2107FK	HR2611FT	DP4000	DDF458							
LS1440	2107FKX	HR2800	DP4001	DFR440							
TW1000	4131	HR2810	DP4002	DFR550							

Nombre	Código	P.V.P. (€)	Nombre	Código	P.V.P. (€)	Nombre	Código	P.V.P. (€)	Nombre	Código	P.V.P. (€)
CB-51	181021-2	1,60	CB-113	191904-8	5,80	CB-303	191963-2	3,20	CB-424	191966-6	2,00
CB-64	191627-8	1,60	CB-132	191972-1	3,80	CB-318*	191978-9	8,40	CB-432	191976-3	3,80
CB-65	191628-6	3,20	CB-153	181044-0	3,20	CB-325	194074-2	1,50	CB-434	191971-3	2,50
CB-70	191914-5	2,50	CB-155*	181048-2	7,40	CB-327*	194285-9	4,50	CB-436	193466-2	2,40
CB-85	191998-3	1,60	CB-171	195844-2	3,80	CB-350*	194160-9	3,80	CB-440	194427-5	3,20
CB-100	181030-1	2,50	CB-203	191953-5	3,20	CB-411	191940-4	2,10	CB-441	194435-6	3,80
CB-105*	181038-5	5,80	CB-204*	191957-7	3,20	CB-415	191950-1	5,00	CB-459	194722-3	2,00
CB-106	181410-1	2,90	CB-253	194547-5	4,40	CB-419	191962-4	1,80	80051B5X	80051B5X	12,60
									957800410	957800410	7,10
									957802410	957802410	6,80
									B45872	B45872	8,40
									EE80700013	EE80700013	6,50
									EE80700019	EE80700019	6,50
									EE80700032	EE80700032	3,20
									EIB106C	HB500	6,50
									JM23000123	JM23000123	3,20
									JM23500117	LS0815FL	6,50
									MO1401045	SL7000	3,20
									W26774	443	
									W49625	446L	
									W49625	447L	
									W49625	W49625	26,30

* Autodesconectantes.

Kits de mantenimiento para martillos



Modelos	Unds.	Código	EAN	P.V.P. (€)
DHR162	1	188580-7	0088381350662	8,40
DHR200	1	195258-5	-	13,70
DHR202	1	195193-7	-	7,40
DHR242 DHR281 DHR282	1	195833-7	-	8,90
DHR243	1	195834-5	-	9,50
BHR261 BHR262 DHR263 DHR264	1	195189-8	-	12,60
HK0500	1	193397-5	-	17,90
HK1810	1	193394-1	-	13,70
HK1820	1	195194-5	-	17,90
HM0810 HM0810T	1	193242-4	-	29,40
HM0830T	1	188048-3	-	20,00
HM0860C	1	195204-8	-	32,60
HM0870C HM0871C	1	195113-1	-	29,40
HM1100 HM1100C	1	193243-2	-	22,10
HM1101C HM1111C	1	195260-8	-	33,60
HM1200 HM1200B	1	193244-0	-	38,90
HM1200K	1	193279-1	-	35,70
HM1202C	1	193391-7	0088381162326	29,40
HM1203C HM1213C HM1214C	1	195114-9	-	35,70
HM1303 HM1303B	1	193393-3	0088381162166	26,30
HM1304 HM1304B	1	195201-4	-	29,40
HM1307C HM1307CB HM1317C	1	195103-4	-	17,90
HM1400	1	193399-1	0088381162210	50,40
HM1801 HM1810	1	195205-6	-	35,70
HM1812	1	197127-6	-	32,60
HR1830	1	188389-7	-	10,50
HR2010	1	193395-9	-	13,70

Modelos	Unds.	Código	EAN	P.V.P. (€)
HR2020 HR2021 HR2432 HR2440 HR2450 HR2450T HR2450FT	1	193606-2	-	17,90
HR2300 HR2600 HR2610	1	195105-0	-	15,80
HR2400	1	193386-0	-	14,70
HR2410 HR2430 HR2431	1	193388-6	-	12,60
HR2230 HR2460 HR2470/T HR2800 HR2810/T HR2811FT	1	195206-4	-	11,60
HR2510	1	193404-4	-	13,70
HR2630	1	196968-7	-	11,60
HR3000C	1	193390-9	0088381162159	22,10
HR3200C HR3210C HR3210FCT	1	195199-5	-	17,90
HR3520 HR3520T	1	193280-6	-	29,40
HR3540C	1	188646-3	-	11,60
HR3850 HR3850B	1	193281-4	-	32,60
HR3850K	1	193282-2	-	38,90
HR4000C	1	193283-0	-	24,20
HR4001C HR4011C	1	195195-3	-	24,20
HR4003C HR4013C	1	196532-4	-	25,20
HR4500C	1	193407-8	0088381162289	24,20
HR4501C HR4511C	1	195210-3	-	26,30
HR5000	1	193284-8	-	22,10
HR5000K	1	193285-6	-	29,40
HR5001C	1	193392-5	0088381163323	29,40
HR5201C HR5211C	1	195191-1	-	26,30
HR5202C HR5212C	1	196865-7	-	35,70



Código	Pág.	P.V.P. (€)
1		
191E07-8	29	160,00
191M90-3	29	93,00
191N09-8	29	258,00
195584-2	29	112,00
196933-6	29	206,00
199687-4	29	113,00
196426-3	29	294,00
198720-9	29	175,00
194533-6	29	76,00
194622-7	29	113,00
191A59-5	29	953,00
191A64-2	29	680,00
191C50-5	29	1.777,00
PDC1200A01	29	1.854,00
PDC1200A02	29	1.741,00
198116-4	29	618,00
198077-8	29	670,00
197626-8	29	824,00
191J39-5	29	479,00
191J97-1	29	695,00
191J81-6	29	505,00
191U13-9	29	803,00
191U00-8	29	711,00
191J65-4	29	386,00
191L47-8	29	314,00
191B26-6	29	268,00
191B36-3	29	211,00
191L29-0	29	191,00
197422-4	29	232,00
197280-8	29	201,00
197265-4	29	170,00
197599-5	29	144,00
197254-9	29	113,00
196235-0	29	93,00
196388-5	29	165,00
197615-3	29	139,00
196875-4	29	110,00
198186-3	29	72,00
198192-8	29	62,00
195423-6	29	53,00
197406-2	29	91,00
197396-9	29	70,00
197363-4	29	112,00
197343-0	29	77,00
196066-7	29	57,00
194588-1	29	47,00
198000-3	29	52,00
SE00000078	29	16,50
TEB00000006	29	32,00
SE00000101	29	24,00
SE00000679	29	31,00
SE00000501	29	14,40
198363-7	29	12,60
WL00000002	29	9,25
WL00000058	29	77,00
191L00-4	29	196,00
191J50-7	30	124,00
191J51-5	30	180,00
191N62-4	30	155,00
195311-7	30	72,00
197580-6	30	141,00
195511-9	30	130,00
197214-1	30	115,00
DECADP05	31	30,00
DEAADP06	31	29,00
DEAADP08	31	29,00
193947-6	31	47,00
195797-5	31	46,00
195798-3	31	48,00
459938-0	31	7,70
454407-6	31	4,65
459937-2	31	6,20
198900-7	31	55,00
198634-2	31	46,00
GM00001605	31	45,00
YL00000004	31	44,00
YL00000003	31	38,00
GM00001499	32	23,00
196351-8	32	43,00
191P89-6	32	89,00
196352-6	32	98,00
197195-9	32	71,00
454226-0	32	3,85
199731-7	33	14,40
199730-9	33	14,40
191A81-2	33	92,00
191B12-7	33	91,00
191F24-4	33	72,00
191A79-9	33	77,00
191A80-4	33	62,00
199729-4	33	34,00
199728-6	33	33,00

Código	Pág.	P.V.P. (€)
191C04-2	33	16,50
191C03-4	33	16,50
191F80-4	33	57,00
191F79-9	33	27,00
199725-2	33	27,00
191F78-1	33	27,00
191A77-3	33	73,00
191A76-5	33	129,00
191A78-1	33	44,00
191M27-0	34	185,00
199137-9	34	188,00
191A57-9	34	268,00
191J59-9	34	371,00
TE00000333	34	0,80
TE00000334	34	0,50
TE00000335	34	0,55
DML810	38	489,00
DML814	38	422,00
ML003GZ	39	216,00
DEADML809	39	443,00
GM00002286	39	19,55
GM00002073	39	213,00
DEADML805	39	174,00
GM00001396	39	20,10
GM00002283	39	67,00
DML811	39	294,00
GM00002287	39	13,40
DML812	40	149,00
DEAML103	40	29,00
DEBDML800	40	46,00
DEBDML186	40	24,00
ML001G	41	50,00
DEBDML808	41	62,00
DEBDML815	41	39,00
DEBDML802	41	55,00
DEBML105	41	58,00
DEAML106	41	62,00
ML002G	42	118,00
DEBDML806	42	77,00
DEAML104	42	102,00
ML006GX	42	84,00
DML816X	42	77,00
DEBDML801	42	48,00
B-57897	44	4,95
B-57906	44	5,20
B-57912	44	8,05
B-57928	44	8,30
B-57940	44	4,95
B-57956	44	5,20
B-57962	44	4,95
B-57978	44	5,20
B-57984	44	6,75
B-57990	44	8,05
B-58001	44	11,15
B-58023	44	7,00
B-58039	44	9,10
B-58045	44	11,40
B-58051	44	13,80
B-58067	44	6,25
B-58073	44	7,00
B-58089	44	10,15
B-58095	44	5,70
B-58104	44	5,95
B-58110	44	7,00
B-58126	44	8,30
B-58132	44	11,40
B-58154	44	18,20
B-58176	44	6,50
B-58198	44	5,95
B-58207	44	6,75
B-58213	44	7,55
B-58229	44	8,85
B-58235	44	11,45
B-58257	44	19,20
B-58263	44	26,00
B-58279	44	63,00
E-14495	44	7,70
E-14504	44	9,25
E-14510	44	10,80
E-14526	44	14,95
E-14532	44	7,20
E-14548	44	8,75
E-14554	44	9,80
E-14560	44	13,90
E-14576	44	21,00
B-58372	44	26,00
B-58388	44	63,00
E-14635	44	10,30
E-14641	44	13,90
E-14657	44	15,95
E-14663	44	17,00
E-14679	44	22,00
E-14685	44	29,00

Código	Pág.	P.V.P. (€)
B-58497	44	65,00
E-14691	44	15,95
E-14700	44	18,00
E-14716	44	19,55
E-14722	44	26,00
E-14738	44	16,50
E-14744	44	18,55
E-14750	44	21,00
E-14766	44	23,00
E-14772	44	29,00
B-58590	44	36,00
B-58609	44	75,00
B-58615	44	27,00
B-58621	44	31,00
B-58637	44	30,00
B-58659	44	36,00
B-58665	44	34,00
B-58687	44	45,00
B-58693	44	43,00
B-58702	44	49,00
B-58718	44	43,00
B-58724	44	54,00
B-58746	44	49,00
B-58752	44	63,00
B-58768	44	55,00
B-58774	44	69,00
B-58780	44	89,00
B-68127	45	2,60
B-68133	45	2,60
B-62496	45	3,15
B-62505	45	3,15
B-62511	45	3,75
B-62527	45	4,05
B-62608	45	3,85
B-62614	45	3,85
B-62620	45	4,40
B-62636	45	4,90
B-62642	45	5,20
B-62664	45	5,15
B-62670	45	5,15
B-62686	45	5,65
B-62692	45	6,20
B-62701	45	6,45
B-62739	45	6,95
B-62745	45	7,45
B-62751	45	8,00
B-62767	45	8,25
B-62773	45	9,25
B-62795	45	10,30
B-62804	45	10,80
B-62810	45	11,35
B-62826	45	11,60
B-62832	45	11,85
B-62854	45	12,35
B-62860	45	12,90
B-62876	45	13,50
B-62882	45	14,65
B-62898	45	15,20
B-68177	45	19,60
B-68236	45	24,00
B-68183	45	25,00
B-68242	45	29,00
B-68199	45	31,00
B-68258	45	38,00
B-68208	45	39,00
B-68264	45	42,00
E-10665	46	5,70
B-47232	46	3,15
B-47248	46	3,65
E-10671	46	5,70
B-46492	46	2,60
B-46501	46	2,85
B-47298	46	2,60
B-47307	46	3,35
B-47313	46	5,95
B-46517	46	2,60
B-46523	46	2,60
B-47341	46	3,90
B-47357	46	4,95
B-47385	46	2,85
B-47391	46	3,35
B-47400	46	4,40
B-47416	46	5,95
B-47438	46	2,85
B-47444	46	3,15
B-47450	46	4,70
B-46539	46	2,85
B-46545	46	3,15
B-47472	46	4,15
B-47488	46	5,20
B-47503	46	9,85
B-47525	46	14,55
B-47531	46	3,90

Código	Pág.	P.V.P. (€)
B-47547	46	5,20
B-47553	46	4,40
B-46551	46	3,40
B-46567	46	3,65
B-47569	46	4,90
B-47575	46	5,70
B-47581	46	6,50
B-47606	46	10,90
B-47612	46	15,05
B-47634	46	38,00
B-47640	46	5,45
B-47656	46	6,00
B-47662	46	7,25
B-46573	46	4,40
B-47684	46	5,45
B-47690	46	6,75
B-47709	46	8,60
B-47721	46	11,95
B-47737	46	15,60
B-47759	46	41,00
B-47765	46	5,45
B-47771	46	6,25
B-47787	46	7,25
B-47793	46	9,35
B-46589	46	6,00
B-47802	46	6,75
B-47818	46	8,35
B-47824	46	9,35
B-47830	46	14,55
B-47846	46	17,15
B-47852	46	42,00
B-47868	46	7,55
B-47874	46	8,80
B-47880	46	9,60
B-47896	46	15,10
B-47905	46	7,30
B-47911	46	8,85
B-47933	46	11,45
B-47949	46	17,15
B-47955	46	21,00
B-47961	46	31,00
B-47977	46	48,00
B-47983	46	13,50
D-15665	47	1,15
D-00016	47	1,20
D-00022	47	1,20
D-00038	47	1,20
D-00044	47	1,20
D-16106	47	1,20
D-00050	47	1,20
D-00066	47	1,20
D-00072	47	1,50
D-00088	47	1,20
D-00094	47	1,20
D-00103	47	1,20
D-00119	47	1,20
D-00125	47	1,20
D-00131	47	1,20
D-00147	47	1,50
D-00153	47	1,85
D-08056	47	1,50
D-00169	47	1,50
D-03274	47	1,50
D-00175	47	1,50
D-00181	47	1,80
D-00197	47	1,80
D-00206	47	2,40
D-17538	47	4,25
D-00228	47	1,50
D-00234	47	1,80
D-00240	47	1,80
D-16271	47	4,55
D-00256	47	1,75
D-16128	47	2,75
D-00262	47	1,85
D-00278	47	2,45
D-17544	47	4,90
D-00290	47	3,45
D-00309	47	4,25
D-16287	47	5,75
D-00321	47	3

Código	Pág.	P.V.P. (€)
E-11411	52	33,00
E-11427	52	32,00
E-11433	52	37,00
E-11449	52	36,00
E-11455	52	42,00
E-11461	52	37,00
E-11477	52	43,00
E-11483	52	47,00
E-11499	52	57,00
E-11508	52	57,00
E-11514	52	70,00
P-17033	53	31,00
P-17049	53	39,00
P-17055	53	55,00
P-17077	53	35,00
P-17083	53	42,00
P-17108	53	35,00
P-17114	53	43,00
P-70655	53	27,00
P-70661	53	34,00
P-70677	53	32,00
P-70683	53	36,00
P-70699	53	34,00
P-70708	53	38,00
P-70714	53	35,00
P-70720	53	39,00
P-70736	53	37,00
P-70742	53	42,00
P-70758	53	41,00
P-70764	53	47,00
P-70770	53	42,00
P-70786	53	47,00
P-70792	53	48,00
P-70801	53	54,00
P-70817	53	48,00
P-70823	53	57,00
P-70839	53	50,00
P-70845	53	61,00
P-70851	53	60,00
P-70867	53	71,00
P-70873	53	71,00
P-70889	53	81,00
P-70895	53	84,00
P-70904	53	101,00
P-03779	54	85,00
P-03785	54	89,00
P-03791	54	108,00
P-03800	54	122,00
P-03816	54	144,00
P-03822	54	166,00
P-16374	54	240,00
P-03838	54	9,35
P-16994	54	43,00
P-17005	54	60,00
P-03763	54	8,80
B-57635	55	185,00
B-57641	55	218,00
B-57657	55	219,00
B-57663	55	246,00
B-57679	55	230,00
B-57685	55	273,00
B-57691	55	254,00
B-57700	55	337,00
P-03888	55	56,00
P-03894	55	47,00
P-03925	55	91,00
P-03931	55	21,00
P-04008	55	129,00
P-03844	55	136,00
P-03850	55	166,00
P-04014	55	183,00
P-04020	55	187,00
P-03866	55	206,00
P-03872	55	262,00
P-04036	55	370,00
P-53914	56	191,00
P-53920	56	27,00
P-53936	56	34,00
P-53942	56	47,00
P-02319	56	147,00
P-17027	56	74,00
B-64238	58	11,40
B-64294	58	7,80
D-08713	58	3,80
P-25096	58	65,00
B-64244	58	11,40
B-64303	58	7,80
D-08729	58	3,65
P-25096	58	65,00
P-24941	58	12,90
P-24957	58	18,00
B-64250	58	16,60
B-64319	58	11,45

Código	Pág.	P.V.P. (€)
D-08735	58	4,90
D-25616	58	5,20
P-24935	58	17,00
P-05533	58	14,95
P-25080	58	13,90
P-24963	58	26,00
P-25105	59	18,55
P-25111	59	25,00
D-05181	59	24,00
A-68161	59	80,00
343411-9	59	29,00
D-16368	59	35,00
D-42357	59	30,00
P-16237	60	8,00
P-16243	60	11,85
P-16259	60	15,70
D-34176	60	5,80
D-34182	60	7,25
D-34182-10	60	66,00
D-34198	60	9,30
B-10366	60	12,35
B-23064	60	19,60
P-16265	60	8,00
P-16271	60	11,85
P-16287	60	15,70
D-34207	60	5,80
D-34213	60	7,55
D-34213-10	60	71,00
D-34229	60	9,00
D-35324-10	60	53,00
P-16302	60	15,95
P-16318	60	24,00
D-34235	60	8,25
D-34241	60	13,35
P-16324	60	24,00
P-16346	60	62,00
P-16293	60	25,00
P-16330	61	49,00
P-23721	61	49,00
A-19875	61	83,00
A-19897	61	40,00
P-03947	61	77,00
P-16352	61	28,00
502024	61	36,00
P-63797	61	41,00
502026	61	46,00
E-13041	61	57,00
D-40565	61	62,00
D-42450	61	46,00
D-08682	62	3,35
D-16863	62	9,30
P-13041	62	21,00
D-20694	62	5,20
P-13079	62	20,15
P-13100	62	37,00
D-08707	62	5,55
D-16879	62	6,10
P-13057	62	14,95
P-13063	62	17,40
P-67393	62	31,00
D-20074	63	8,40
D-19196	63	9,50
P-13122	63	15,30
P-13138	63	19,65
P-05620	63	15,45
P-05614	63	20,10
P-13144	63	15,65
P-13150	63	18,50
P-05636	63	14,60
P-05642	63	19,60
P-05670	63	63,00
P-13188	63	23,00
P-05658	63	23,00
P-13219	63	54,00
P-13166	63	27,00
P-05664	63	29,00
P-05686	63	37,00
D-23824	64	9,00
P-13378	64	17,80
P-13384	64	23,00
P-13390	64	24,00
P-13409	64	18,60
P-13415	64	24,00
P-13437	64	39,00
798035-0	64	92,00
D-15285	65	16,55
P-05549	65	31,00
B-10388*	65	35,00
P-05561	65	45,00
D-23868	65	21,75
D-34805	65	21,75
P-13518	65	73,00
P-13493	65	61,00

Código	Pág.	P.V.P. (€)
D-15300	65	17,15
P-13487	65	30,00
P-13502	65	31,00
P-05583	65	44,00
A-31485	65	115,00
P-05555	65	76,00
B-10300	65	99,00
P-05608	65	58,00
P-05692	66	28,00
P-64272	66	47,00
B-10372*	66	32,00
D-17631	66	18,90
P-65931	66	36,00
D-29228	66	20,05
P-05701	66	49,00
P-05717	66	70,00
P-05723	66	27,00
P-64288	66	47,00
D-17647	66	18,90
P-65947	66	36,00
798385-3	66	203,00
P-13231	67	18,05
P-13253	67	23,00
P-13269	67	25,00
P-13312	67	31,00
A-07157	67	93,00
P-13275	67	18,05
P-13297	67	21,00
P-13306	67	27,00
P-13334	67	54,00
B-06921	68	13,40
P-05496	68	24,00
P-05474	68	25,00
122431-4	68	64,00
343411-9	68	29,00
B-07004	68	16,75
B-07010	68	19,05
P-05480	68	28,00
122829-5	69	61,00
194079-2	69	60,00
199139-5	69	51,00
194568-7	69	69,00
191F46-4	69	51,00
194080-7	69	31,00
199138-7	69	22,00
125420-8	69	55,00
191F47-2	69	32,00
D-54972	69	138,00
P-18150	69	44,00
D-14093	69	2,60
765009-6	69	2,30
P-08361	69	3,10
443122-7	69	3,05
183477-5	69	3,85
198993-4	69	6,20
195898-9	70	114,00
195902-4	70	114,00
199664-6	70	91,00
199581-0	70	145,00
199585-2	70	145,00
191F95-1	70	113,00
191G00-4	70	113,00
191E54-9	70	160,00
199557-7	70	11,00
196162-1	70	30,00
199596-7	70	8,75
191F49-8	70	49,00
136017-8	70	89,00
136018-6	70	95,00
193472-7	71	46,00
198362-9	71	15,60
194581-5	71	13,40
194582-3	71	5,10
194583-1	71	4,80
191L91-5	71	5,60
193976-9	71	13,40
122708-7	71	8,45
421342-3	71	2,30
421664-1	71	3,60
423154-0	71	0,75
195173-3	71	7,05
195179-1	71	8,40
195870-1	71	103,00
196074-8	72	105,00
196858-4	72	77,00
199142-6	72	100,00
197168-2	73	53,00
191M20-4	73	63,00
158057-6	74	4,55
273496-0	74	11,35
152554-4	74	8,50
273472-4	74	10,30
134803-1	74	28,00

Código	Pág.	P.V.P. (€)
158131-0	74	10,30
273457-0	74	10,80
134887-9	74	37,00
134890-0	74	34,00
134915-0	74	28,00
134945-1	74	28,00
135269-8	74	39,00
134944-3	74	22,00
134909-5	74	26,00
135283-4	74	38,00
196792-8	74	25,00
135302-6	74	3,70
122878-2	74	13,10
134889-5	74	20,10
135197-7	74	20,10
135209-6	74	21,00
134916-8	74	23,00
134881-1	74	26,00
135380-6	74	23,00
135332-7	74	22,00
P-64462	76	29,00
P-64478	76	29,00
P-64484	76	33,00
P-64490	76	34,00
P-64509	76	35,00
P-64515	76	36,00
P-64521	76	38,00
P-64537	76	42,00
P-64543	76	42,00
P-64559	76	42,00
P-64565	76	43,00
P-64571	76	46,00
P-64587	76	52,00
P-64593	76	53,00
P-64602	76	54,00
P-64618	76	55,00
P-64630	76	57,00
P-64646	76	62,00
P-64652	76	64,00
P-64668	76	83,00
P-64319	76	28,00
P-64331	76	34,00
P-64347	76	6,25
D-05228	77	1,15
D-05234	77	1,15
D-05240	77	1,15
D-05256	77	1,15
D-05262	77	1,15
D-05278	77	1,15
D-05284	77	1,15
D-05290	77	1,15
D-05309	77	1,15
D-05315	77	1,15
D-05321	77	1,45
D-05337	77	1,45
D-05343	77	2,00
D-05359	77	2,60
D-05365	77	2,60
D-05371	77	2,60
D-05387	77	2,90
D-23793	77	1,95
D-23802	77	2,00
D-23818	77	2,70
D-15942	77	2,60
D-15958	77	2,60
D-15964	77	2,85
D-15970	77	2,85
D-15986	77	3,50
E-06351	77	1,40
E-06367	77	1,40
E-06373	77	1,40
E-06389	77	1,40
E-06410	77	1,40
E-06426	77	1,40
E-06482	77	1,40
E-06498	77	1,40
E-06529	77	1,40
E-06535	77	2,85
E-06541	77	2,25
E-06557	77	3,10
E-06563	77	2,85

Código	Pág.	P.V.P. (€)
D-07749	80	2,05
D-07755	80	2,05
D-07761	80	2,05
D-07777	80	2,65
D-07783	80	2,65
D-07799	80	2,65
D-07808	80	2,90
D-07814	80	3,20
D-07820	80	3,55
D-07836	80	3,80
D-07842	80	3,80
D-07858	80	4,10
D-41844	80	6,15
D-41925	80	7,25
D-42232	80	8,35
D-42248	80	8,95
D-42254	80	9,50
D-42260	80	10,00
D-42276	80	10,60
D-42282	80	11,15
D-42298	80	12,85
D-42307	80	17,55
D-74304	81	11,85
D-74310	81	13,90
D-74326	81	15,45
D-74332	81	16,50
D-74348	81	18,55
D-74354	81	22,00
D-74360	81	24,00
D-74376	81	27,00
D-74382	81	32,00
D-74398	81	36,00
D-74407	81	54,00
D-74413	81	63,00
D-74429	81	80,00
D-74435	81	1,30
D-74441	81	1,30
D-74457	81	10,30
D-74463	81	12,35
D-74479	81	14,95
D-38299	84	1,15
D-38308	84	1,15
D-38314	84	1,10
D-38336	84	1,15
D-38358	84	1,15
D-38364	84	1,15
D-38386	84	0,85
D-38401	84	0,85
D-38417	84	0,85
D-38423	84	0,85
D-38439	84	1,15
D-38445	84	1,15
D-38451	84	1,15
D-38467	84	1,40
D-38473	84	1,40
D-38489	84	1,70
D-38495	84	2,00
D-38504	84	2,55
D-38510	84	3,10
D-38526	84	3,40
D-09656	84	0,85
D-09662	84	0,80
D-09678	84	0,85
D-09684	84	0,85
D-09690	84	1,10
D-09709	84	1,10
D-09715	84	1,20
D-09721	84	1,45
D-09737	84	1,65
D-09743	84	1,75
D-09759	84	1,90
D-09765	84	2,25
D-09771	84	2,50
D-09787	84	3,25
D-09793	84	3,00
D-09802	84	3,55
D-09818	84	3,80
D-09824	84	4,35
D-09830	84	5,70
D-09846	84	6,00
D-09852	84	6,55
D-09868	84	7,10
D-09874	84	7,60
D-09880	84	8,20
D-42961	85	3,10
D-42977	85	3,10
D-42983	85	3,10
D-43000	85	3,10
D-43038	85	3,10
D-43044	85	3,10
D-43072	85	2,05
D-43094	85	2,30
D-43119	85	2,60

Código	Pág.	P.V.P. (€)
D-43125	85	2,85
D-43131	85	3,10
D-43147	85	3,10
D-43153	85	3,60
D-43169	85	5,40
D-43175	85	5,40
D-43181	85	6,70
D-43197	85	6,95
D-43206	85	7,20
D-45375	85	10,30
D-43212	85	10,30
D-45381	85	10,30
D-43228	85	13,40
D-45397	85	15,20
D-43234	85	15,95
D-14928	85	1,65
D-14934	85	1,90
D-14940	85	1,90
D-14962	85	2,20
D-14978	85	3,00
D-17778	85	4,10
D-15827	85	5,70
D-15833	85	8,70
D-15849	85	11,45
D-15855	85	14,70
B-56437	85	12,00
D-17289	86	1,35
D-17295	86	1,35
D-17304	86	1,40
D-17310	86	1,45
D-17332	86	1,45
D-17348	86	1,65
D-17354	86	1,90
D-17360	86	1,95
D-17376	86	2,45
D-17382	86	2,55
D-17398	86	3,00
D-17407	86	3,45
D-17413	86	4,65
D-17429	86	5,70
D-17435	86	6,00
D-17441	86	6,00
D-17457	86	8,05
D-17463	86	9,05
D-17479	86	10,10
D-17485	86	10,35
D-17491	86	12,95
D-17500	86	13,10
D-17516	86	15,55
D-17522	86	16,65
B-57401	86	3,25
B-57417	86	3,25
B-57423	86	3,80
B-57439	86	3,85
B-57445	86	4,65
B-57451	86	4,65
B-57467	86	4,65
B-57473	86	5,20
B-57489	86	3,50
B-57495	86	3,55
B-57504	86	3,50
B-57510	86	4,10
B-57526	86	4,40
B-57532	86	13,80
D-40048	86	17,85
D-40054	86	27,00
D-40060	86	50,00
D-40076	86	90,00
D-40107	86	68,00
D-40135	86	78,00
D-40163	86	73,00
D-40191	86	89,00
12S	87	22,00
12L	87	30,00
13S	87	22,00
13L	87	31,00
14S	87	22,00
14L	87	32,00
15S	87	23,00
15L	87	33,00
16S	87	24,00
16L	87	34,00
17S	87	24,00
17L	87	35,00
18S	87	24,00
18L	87	37,00
19S	87	25,00
19L	87	39,00
20S	87	27,00
20L	87	41,00
21S	87	28,00
21L	87	44,00
22S	87	29,00

Código	Pág.	P.V.P. (€)
22L	87	44,00
23S	87	30,00
23L	87	46,00
24S	87	31,00
24L	87	48,00
25S	87	35,00
25L	87	50,00
26S	87	36,00
26L	87	53,00
27S	87	37,00
27L	87	56,00
28S	87	42,00
28L	87	57,00
29S	87	43,00
29L	87	60,00
30S	87	44,00
30L	87	63,00
31S	87	45,00
31L	87	65,00
32S	87	46,00
32L	87	68,00
33S	87	47,00
33L	87	73,00
34S	87	49,00
34L	87	74,00
35S	87	53,00
35L	87	77,00
36S	87	52,00
36L	87	80,00
37S	87	54,00
37L	87	83,00
38S	87	58,00
38L	87	84,00
39S	87	59,00
39L	87	93,00
40S	87	67,00
40L	87	98,00
41S	87	68,00
41L	87	102,00
42S	87	69,00
42L	87	104,00
43S	87	71,00
43L	87	107,00
44S	87	73,00
44L	87	111,00
45S	87	74,00
45L	87	124,00
46S	87	82,00
46L	87	128,00
47S	87	84,00
47L	87	136,00
48S	87	85,00
48L	87	141,00
49S	87	88,00
49L	87	143,00
50S	87	90,00
50L	87	145,00
PILOTS	87	7,20
PILOT	87	9,00
D-37306	89	4,60
D-37312	89	6,00
D-37328	89	7,10
D-37334	89	8,20
D-37340	89	8,70
D-37356	89	13,10
D-37362	89	15,80
D-37378	89	5,95
D-37384	89	6,55
D-37390	89	8,15
D-37409	89	9,25
D-37415	89	10,90
D-37421	89	14,70
D-37437	89	6,00
D-37443	89	7,60
D-37459	89	8,75
D-37465	89	9,30
D-37471	89	12,50
D-37487	89	16,35
D-37493	89	20,15
D-37502	89	10,90
D-37518	89	17,85
D-37524	89	27,00
D-37530	89	48,00
D-67561	90	58,00
D-67583	90	62,00
D-67549	90	46,00
D-67527	90	23,00
D-72833	90	6,00
D-54081	90	18,10
D-72877	90	5,45
E-11536	90	7,70
D-46202	91	21,55
D-71962	91	7,95

Código	Pág.	P.V.P. (€)
D-72861	91	4,95
E-08698	91	20,60
D-20769	91	12,05
D-23759	91	9,50
D-30477	91	6,60
E-07054	92	24,00
D-40200	92	14,95
E-07026	92	29,00
B-50295	92	38,00
D-73461	92	30,00
D-73477	92	28,00
D-73455	92	8,75
E-10730	93	54,00
B-68432	93	44,00
E-06270	93	97,00
E-11689	93	113,00
B-54520	94	53,00
D-36980	94	27,00
D-33691	94	68,00
D-31778	95	89,00
D-37194	96	152,00
B-69478	97	110,00
B-49638	97	110,00
B-49725	97	139,00
B-49884	97	149,00
D-35368	98	3,40
D-16994	98	3,50
D-35374	98	4,00
D-17005	98	3,95
D-17251	98	4,25
D-35380	98	4,50
D-17011	98	4,50
D-17027	98	5,10
D-17033	98	5,10
D-35396	98	5,10
D-17267	98	5,10
D-35405	98	5,35
D-17049	98	5,40
D-35411	98	5,65
D-17055	98	5,95
D-35427	98	5,95
D-17061	98	5,95
D-17273	98	6,25
D-35433	98	6,50
D-35449	98	6,80
D-17077	98	6,80
D-35455	98	7,35
D-35461	98	7,65
D-17083	98	7,95
D-35477	98	7,65
D-24876	98	7,65
D-35483	98	8,30
D-17099	98	8,30
D-35499	98	8,30
D-25688	98	8,35
D-30140	98	8,90
D-24882	98	8,85
D-35508	98	9,50
D-17108	98	9,55
D-25694	98	10,20
D-35514	98	10,50
D-17114	98	10,75
D-35520	98	10,75
D-17120	98	11,05
D-35536	98	11,05
D-35542	98	11,90
D-17136	98	11,90
D-35558	98	12,15
D-35564	98	12,45
D-35570	98	13,15
D-17142	98	13,60
D-35586	98	15,00
D-35592	98	15,55
D-35601	98	16,15
D-35617	98	16,70
D-17158	98	17,25
D-35623	98	18,95
D-17164	98	20,40
D-17170	99	4,05
D-17186	99	7,35
D-17603	99	5,95
D-17619	99	9,70
D-17192	99	2,95
D-47298	99	102,00
D-47117	99	45,00
D-47123	99	38,00
D-47139	99	45,00
B-11265*	100	8,00
B-31706	100	8,00
E-03654	100	8,00
E-03660	100	8,00
E-03676	100	8,50
E-03698	100	10,30

Código	Pág.	P.V.P. (€)
E-03707	100	9,80
E-0371		

Código	Pág.	P.V.P. (€)
196008-1*	105	11,35
766016-2	105	9,00
193822-6*	105	26,00
192877-8	105	35,00
193228-8	105	37,00
193224-6	105	40,00
193519-7	105	51,00
763062-6	105	42,00
193318-7	105	48,00
763174-5	105	38,00
193706-8	105	6,70
E-03121	110	3,10
E-03137	110	3,10
E-03159	110	3,10
E-03268	110	6,20
E-03274	110	6,20
E-03280	110	6,20
E-03165	110	3,10
E-03171	110	3,10
E-03187	110	3,10
E-03296	110	6,20
E-03305	110	6,20
E-03311	110	6,20
E-03193	110	3,10
E-03202	110	3,10
E-03218	110	3,10
E-03224	110	3,10
E-03230	110	3,10
E-12027	110	4,90
E-03327	110	6,20
E-03333	110	6,20
E-03349	110	6,20
E-03355	110	6,20
E-03361	110	6,20
E-03442	110	4,10
E-03414	111	9,25
E-03573	111	23,00
E-03420	111	6,20
E-03436	111	6,20
E-06286	111	9,25
E-06292	111	9,25
E-03399	111	8,20
E-03408	111	8,75
E-03492	111	8,75
E-03517	111	9,25
E-03523	111	9,55
E-03458	111	6,20
E-03464	111	6,20
E-03470	111	6,20
E-03486	111	6,45
B-66880	112	40,00
B-66818	112	5,65
B-66793	112	4,55
B-66824	112	3,10
B-66830	112	3,15
B-66846	112	3,10
B-66852	112	3,15
E-12441-10	113	227,00
B-63600	113	1,65
B-63616	113	1,65
B-63622	113	1,65
B-63719	113	2,45
B-63725	113	2,45
B-63731	113	2,45
B-63638	113	1,65
B-63644	113	1,65
B-63650	113	1,65
B-63747	113	2,45
B-63753	113	2,45
B-63769	113	2,45
B-63666	113	1,65
B-63672	113	1,65
B-63688	113	1,65
B-63694	113	1,65
B-63703	113	1,65
B-63775	113	2,45
B-63781	113	2,45
B-63797	113	2,45
B-63806	113	2,45
B-63812	113	2,45
E-12360	113	13,65
E-12407	113	9,80
E-12376	113	13,65
E-12413	113	9,80
E-12382	113	13,65
E-12398	113	13,65
E-12653	113	13,65
E-12669	113	13,65
E-12429	113	9,80
E-12435	113	9,80
E-12675	113	9,80
E-12681	113	9,80
191L24-0	114	95,00

Código	Pág.	P.V.P. (€)
199155-7	114	44,00
P-13552	114	3,70
P-66793	114	12,35
P-13568	114	5,90
P-21593	114	4,65
P-67795	114	16,50
P-67804	114	19,55
P-13574	114	3,60
P-66824	114	12,35
P-13580	114	5,65
P-21618	114	20,10
P-67773	114	16,50
P-67789	114	19,55
D-61690	114	1,95
P-06030	114	8,25
P-06052	114	8,25
P-06074	114	8,25
798312-0	114	2,05
P-06046	114	24,00
P-06068	114	23,00
P-06080	114	23,00
P-06096	114	8,25
P-06111	114	8,25
P-06133	114	8,25
P-06105	114	23,00
P-06127	114	23,00
P-06149	114	23,00
P-06177	114	13,40
P-06199	114	13,40
P-06214	114	13,40
P-06242	114	14,40
P-21375	114	21,00
P-21381	114	21,00
P-21397	114	21,00
P-21406	114	21,00
P-21412	114	28,00
P-06323	114	13,40
P-06339	114	13,40
P-06345	114	13,40
P-06351	114	13,40
P-06367	114	13,40
P-06373	114	13,40
P-06389	114	13,40
P-54075	115	18,00
P-53263	115	17,50
784811-8	115	3,75
784801-1	115	3,20
B-29072	115	6,80
B-29094	115	8,50
B-51867	115	34,00
B-57548	115	6,20
B-52532	116	25,00
B-52548	116	27,00
B-52554	116	46,00
B-52582	116	25,00
B-52598	116	27,00
B-52607	116	46,00
B-52635	116	27,00
B-52641	116	30,00
B-52657	116	48,00
B-40266	116	9,80
B-40272	116	10,05
B-40288	116	10,30
B-38685	116	2,25
B-38691	116	2,25
B-38700	116	4,50
B-38716	116	2,30
B-38722	116	2,25
B-38738	116	2,30
B-38744	116	4,55
B-38750	116	4,55
784806-1	116	21,00
784805-3	116	22,00
B-42961	117	18,00
B-42977	117	18,55
B-42983	117	19,05
B-54667	117	2,70
B-54673	117	3,55
B-57738	117	8,70
B-57744	117	10,65
B-57554	117	6,25
P-44074	117	11,85
784830-A	117	15,95
B-48751	117	4,80
B-52934	117	5,40
B-48767	117	5,95
B-48773	117	16,35
B-48789	117	16,35
D-73271	118	4,15
E-00022	118	220,00
D-30667	118	11,35
D-31669	118	50,00
D-34914	118	50,00

Código	Pág.	P.V.P. (€)
B-24876	118	27,00
B-24882	118	27,00
B-26490	118	26,00
B-26509	118	26,00
D-34366	118	9,20
D-64995	118	9,75
B-36170	119	31,00
B-54081	119	34,00
B-42438	119	19,05
B-42450	119	19,05
B-28606	119	22,00
E-07060	120	31,00
E-06616	120	129,00
E-10883	120	201,00
E-08713	121	140,00
E-11542	121	162,00
E-08458	122	152,00
E-10899	122	102,00
B-39883	123	3,55
B-39899	123	3,55
B-39908	123	3,55
B-39914	123	3,55
B-39920	123	3,55
B-39936	123	3,55
B-39942	123	3,50
B-39958	123	4,10
B-39964	123	4,10
B-39970	123	4,35
B-39986	123	4,35
B-39992	123	4,35
B-40004	123	4,90
A-89931	123	4,10
134867-5	123	33,00
134825-1	123	4,90
134827-7	123	6,45
134826-9	123	4,90
134828-5	123	5,15
B-10506	123	4,90
134829-3	123	4,90
134830-8	123	4,90
134831-6	123	5,65
134832-4	123	5,65
134837-4	123	8,00
134838-2	123	6,20
134833-2	123	7,20
134839-0	123	8,75
134851-0	123	6,45
134834-0	123	7,20
134840-5	123	6,45
134835-8	123	7,70
134841-3	123	7,70
134836-6	123	8,00
134842-1	123	8,50
134843-9	123	10,80
134844-7	123	7,70
134845-5	123	11,85
134846-3	123	9,25
134847-1	123	12,35
134848-9	123	9,00
134849-7	123	12,90
A-85494	123	9,80
A-85503	123	19,55
A-85519	123	10,30
A-85525	123	19,55
A-85531	123	10,30
A-85547	123	19,55
A-85553	123	10,30
A-85569	123	19,55
A-85575	123	10,30
A-85581	123	18,55
134853-6	123	11,35
134854-4	123	23,00
134855-2	123	10,30
134856-0	123	21,00
134857-8	123	10,30
134858-6	123	18,00
134871-4	123	10,30
134859-4	123	18,55
134860-9	123	13,40
134861-7	123	25,00
134862-5	123	14,95
134863-3	123	22,00
134864-1	123	23,00
134865-9	123	22,00
134872-2	123	24,00
213397-0	123	1,00
213398-8	123	1,00
213399-6	123	1,00
213461-7	123	1,00
213514-2	123	1,00
213570-2	123	1,00
268056-1	123	1,00
268057-9	123	1,00

Código	Pág.	P.V.P. (€)
256283-2	123	1,00
256282-4	123	1,00
256284-0	123	1,00
D-41517	124	54,00
E-12354	124	31,00
191A50-3	124	20,10
191A51-1	124	20,10
194281-7	124	28,00
134745-9	124	19,00
134746-7	124	18,55
192439-2	124	154,00
192440-7	124	69,00
134874-8	124	23,00
134997-2	124	49,00
134870-6	124	67,00
134877-2	125	66,00
134998-0	125	100,00
P-05941	125	43,00
P-05963	125	37,00
B-68448	125	16,20
194500-1	125	83,00
197043-2	125	30,00
191G67-2	125	129,00
763198-1	126	26,00
784643-3	126	4,65
455591-0	126	1,75
699020-5	126	12,55
194330-0	126	24,00
194906-3	126	37,00
122464-9	126	17,50
122727-3	126	21,00
450963-4	126	1,80
450967-6	126	1,20
450968-4	126	1,20
122867-7	126	6,10
122868-5	126	6,75
158875-2	126	6,70
158876-0	126	7,25
322120-3	126	8,00
322124-5	126	12,35
322125-3	126	12,90
322119-8	126	18,55
322126-1	126	13,90
D-45668	129	3,00
D-45674	129	3,80
D-45680	129	4,35
D-45696	129	6,00
D-45705	129	3,00
D-45711	129	3,80
D-45727	129	4,35
D-45733	129	6,00
D-40004	129	1,65
D-40010	129	1,90
D-40026	129	2,45
D-40032	129	2,70
D-73704	129	1,35
D-73710	129	1,55
D-73726	129	1,85
D-73732	129	2,10
D-73835	129	2,25
D-73841	129	2,90
D-73857	129	3,40
D-73863	129	4,45
D-45509	130	4,90
D-45515	130	6,55
D-45521	130	7,60
D-45537	130	4,90
D-45543	130	6,55
D-45559	130	7,60
D-39908	130	1,95
D-39914	130	2,20
D-39920	130	2,45
D-39936	130	2,70

Código	Pág.	P.V.P. (€)
416368-8	138	2,05
782209-3	138	2,10
782203-5	138	2,90
781213-9	138	2,05
762001-3	138	0,80
B-12712	141	138,00
B-13459	141	200,00
B-13465	141	258,00
B-13471	141	308,00
B-12762	142	45,00
B-12778	142	46,00
B-12784	142	104,00
B-13546	142	155,00
B-13552	142	184,00
B-13568	142	222,00
B-12980	143	41,00
B-12996	143	46,00
B-13007	143	56,00
B-13035	143	91,00
B-13041	143	168,00
B-13057	143	220,00
B-13063	143	71,00
B-13085	143	27,00
B-13091	143	29,00
B-13172	143	54,00
B-13188	143	55,00
B-13194	143	74,00
B-13219	143	144,00
B-13225	143	263,00
B-13253	144	96,00
B-13269	144	173,00
B-13275	144	202,00
B-53986	144	23,00
B-53992	144	25,00
B-54025	144	33,00
B-54031	144	58,00
B-54053	144	74,00
B-54069	144	95,00
D-61123	145	8,15
D-52766	145	8,15
B-06432	145	21,00
D-61145	145	17,50
D-56982	145	63,00
D-56998	145	78,00
D-57009	145	91,00
D-61151	145	8,15
D-61167	145	9,35
D-61173	145	20,95
D-61189	145	7,00
E-02967	146	139,00
E-02060	146	37,00
E-02076	146	40,00
B-21098	147	35,00
B-22028	147	94,00
B-21951	147	37,00
B-46327	147	36,00
B-46333	147	39,00
B-55310	148	52,00
B-55326	148	97,00
B-55332	148	175,00
B-12289	148	210,00
B-12295	148	103,00
D-41464	148	62,00
D-41458	148	54,00
P-57102	150	67,00
P-57118	150	69,00
P-57124	150	69,00
P-57146	150	69,00
P-57152	150	70,00
P-57174	150	72,00
P-63806	150	97,00
P-63828	150	124,00
P-63921	150	165,00
P-64060	150	39,00
P-64076	150	41,00
P-64082	150	43,00
P-64098	150	43,00
P-64107	150	47,00
P-64113	150	48,00
P-64129	150	49,00
P-41604	150	34,00
P-41610	150	39,00
P-41626	150	49,00
P-41632	150	63,00
P-41648	150	79,00
P-41551	150	24,00
P-34718	150	24,00
P-41888	151	25,00
P-41903	151	74,00
P-34724	151	17,50
P-41676	151	49,00
P-41682	151	48,00
P-41698	151	39,00

Código	Pág.	P.V.P. (€)
P-10067	151	15,70
P-10073	151	16,50
P-41707	151	45,00
P-42151	151	33,00
P-41866	151	18,45
P-45082	151	35,00
P-30031	151	20,10
P-67745	151	21,00
P-41919	151	3,35
P-41931	151	4,90
P-41981	151	10,80
P-41872	151	134,00
D-35025	151	21,25
D-35019	151	25,00
D-35003	151	26,00
D-61070	151	17,40
D-61086	151	17,95
D-61092	151	18,50
D-61101	151	26,00
D-44432	151	36,00
D-44454	151	28,00
D-44476	151	35,00
D-44507	151	44,00
D-44529	151	55,00
P-54184	151	28,00
P-54178	151	196,00
P-54221	151	97,00
P-40082	152	721,00
P-54190	152	1.324,00
P-40098	152	35,00
P-40288	152	12,35
P-40107	152	1,80
P-40113	152	9,55
P-40129	152	4,40
P-41735	152	12,35
D-15584	152	14,85
D-15609	152	14,85
D-15621	152	14,85
D-15643	152	14,85
D-15659	152	24,00
743080-0	152	25,00
P-52978	155	1,55
P-52984	155	1,80
P-52990	155	2,60
P-52227	155	3,10
P-52819	155	4,40
E-00365	155	1,75
E-00393	155	2,05
E-00371	155	2,25
E-00402	155	2,80
B-56378	155	3,60
B-56390	155	4,10
E-00387	155	1,85
E-00418	155	2,05
P-52174	155	1,10
P-52180	155	1,30
P-52928	155	1,80
P-52934	155	1,80
P-52196	155	2,40
P-52205	155	1,30
P-52940	155	1,55
P-52962	155	2,05
P-52211	155	2,85
P-53148	155	3,85
P-53154	155	5,15
724409-9	155	43,00
721710-3	155	15,45
721715A3	155	23,00
724406-5	155	43,00
P-53001	155	1,30
P-53017	155	1,30
P-53023	155	1,35
P-53039	155	1,35
P-52233	155	3,10
P-52249	155	1,30
P-52255	155	1,30
P-53045	155	1,30
P-53051	155	1,35
P-53067	155	3,10
P-53073	155	1,30
P-53089	155	1,80
P-53095	155	1,35
P-53126	155	1,30
D-65953-10	156	6,90
D-65969-10	156	7,95
E-10861-12	156	19,55
E-10877-12	156	22,00
E-03006-25	156	57,00
E-10718	156	1,55
E-10724	156	1,80
B-10665-5	157	21,00
E-04977-5	157	39,00
B-28662	157	57,00

Código	Pág.	P.V.P. (€)
B-28678	157	57,00
B-28684	157	72,00
B-28690	157	72,00
B-51976	157	28,00
B-51960	157	22,00
B-51932	157	15,40
B-51926	157	13,80
D-27034	158	3,15
D-27040	158	3,15
D-27056	158	3,15
D-27062	158	3,15
D-27084	158	3,60
D-27090	158	3,60
D-27109	158	3,60
D-27115	158	3,60
D-27137	158	7,20
D-27143	158	7,20
D-27159	158	7,20
D-27165	158	7,20
D-28298	158	6,45
D-28307	158	6,45
D-28313	158	6,45
D-28329	158	6,45
D-28335	158	7,45
D-28341	158	7,45
D-28357	158	7,45
D-28363	158	7,45
D-28379	158	13,40
D-28385	158	13,40
D-28391	158	13,40
D-28400	158	13,40
D-53724	159	2,90
D-53730	159	2,90
D-53746	159	2,90
D-53752	159	2,90
D-53774	159	3,35
D-53780	159	3,35
D-53796	159	3,35
D-53805	159	3,35
D-53827	159	7,45
D-53833	159	7,45
D-53849	159	7,45
D-53855	159	7,45
D-63747	159	1,85
D-63753	159	1,85
D-63769	159	1,85
D-63775	159	1,85
D-63781	159	2,15
D-63797	159	2,15
D-63806	159	2,10
D-63812	159	2,10
D-63828	159	4,25
D-63834	159	4,25
D-63840	159	4,25
D-63856	159	4,25
D-27838	159	5,15
D-27844	159	5,15
D-27850	159	5,15
D-27866	159	5,15
D-27888	159	6,20
D-27894	159	6,20
D-27903	159	6,20
D-27919	159	6,20
D-27931	159	10,30
D-27947	159	10,30
D-27953	159	10,30
D-27969	159	10,30
D-28036	160	3,70
D-28042	160	3,70
D-28058	160	3,70
D-28064	160	3,70
D-28086	160	4,20
D-28092	160	4,20
D-28101	160	4,20
D-28117	160	4,20
D-28139	160	7,20
D-28145	160	7,20
D-28151	160	7,20
D-28167	160	7,20
D-28173	160	5,15
D-28189	160	5,15
D-28195	160	5,15
D-28204	160	5,15
D-28210	160	10,30
D-28226	160	10,30
D-28232	160	10,30
D-28248	160	10,30
B-28977	160	9,55
B-28983	160	10,55
B-40917	161	9,55
B-40951	161	11,05
B-40923	161	9,55
B-40967	161	11,05

Código	Pág.	P.V.P. (€)
B-40939	161	9,55
B-40973	161	11,05
B-40945	161	9,55
B-40989	161	11,05
794050-2	161	1,30
794051-0	161	1,30
794053-6	161	1,30
794059-4	161	2,85
153489-2	162	1,10
162258-0	162	12,85
152492-0	162	2,85
151776-3	162	10,80
162264-5	162	15,00
194684-5	162	13,80
198440-5	162	136,00
196845-3	162	76,00
191G06-2	162	81,00
191F81-2	162	49,00
195239-9	162	49,00
195385-8	162	66,00
123098-1	163	7,20
123098-1	163	7,20
123098-1	163	7,20
123099-9	163	7,75
123099-9	163	7,75
123099-9	163	7,75
123099-9	163	7,75
123145-8	163	9,10
123145-8	163	9,10
123145-8	163	9,10
123146-6	163	11,35
123098-1	163	7,20
123098-1	163	7,20
123144-0	163	9,75
123098-1	163	7,20
123145-8	163	9,10
123099-9	163	7,75
123099-9	163	7,75
123145-8	163	9,10
123145-8	163	9,10
123146-6	163	11,35
123146-6	163	11,35
122846-5	163	13,05
122889-7	163	8,95
122889-7	163	8,95
122889-7	163	8,95
122889-7	163	8,95
122889-7	163	8,95
122889-7	163	8,95
122889-7	163	8,95
122889-7	163	8,95
163411-1	163	30,00
122891-0	163	10,30
122891-0	163	10,30
122891-0	163	10,30
122891-0	163	10,30
122891-0	163	10,30
122891-0	163	10,30
122913-6	163	16,30
199709-0	163	9,40
199710-5	163	9,90
224415-9	163	1,50
224543-0	163	1,95
192454-6	164	39,00
123199-5	164	22,00
D-23200-6	164	23,00
195354-9	164	41,00
192227-7	164	14,40
125052-1	164	11,35
199514-5	164	26,00
198719-4	164	16,05
193903-6	164	14,95
195446-4	164	11,3

Código	Pág.	P.V.P. (€)
P-42759	173	3,85
P-42765	173	3,85
P-31871	174	5,15
P-31887	174	4,65
P-31893	174	4,65
P-31902	174	4,65
P-35891	174	4,65
P-35900	174	4,65
P-35916	174	4,65
P-35922	174	4,65
P-36136	174	3,10
P-32948	174	2,85
P-36142	174	2,85
P-32954	174	2,85
P-36158	174	2,85
P-32960	174	2,30
P-31837	174	3,60
P-31843	174	3,35
P-31859	174	3,35
P-31865	174	3,35
P-36011	174	3,35
P-36027	174	3,35
P-36033	174	3,35
P-36049	174	3,35
P-33174	175	6,45
P-33180	175	6,20
P-33196	175	6,20
P-33205	175	6,20
P-33211	175	6,20
P-33233	175	5,90
P-33249	175	5,90
P-43022	175	7,20
P-43038	175	6,70
P-43044	175	6,45
P-43050	175	6,20
P-43066	175	6,20
P-43072	175	5,65
P-43088	175	6,20
P-43094	175	6,20
P-33009	175	4,40
P-33015	175	4,10
P-33021	175	4,10
P-33037	175	4,10
P-33043	175	4,10
P-33059	175	4,10
P-33065	175	4,10
P-33071	175	3,85
P-36267	175	4,10
P-32976	175	3,85
P-36273	175	3,85
P-32982	175	3,85
P-36289	175	3,85
P-32998	175	3,10
P-38102	176	8,00
P-38118	176	6,20
P-38124	176	5,40
P-38130	176	5,15
P-38146	176	5,15
P-38152	176	5,15
P-38168	176	5,15
P-38174	176	5,15
P-38180	176	4,10
P-38196	176	55,00
P-38205	176	45,00
P-38211	176	39,00
P-38227	176	36,00
P-38233	176	36,00
P-38249	176	36,00
P-38255	176	36,00
P-38261	176	36,00
P-38277	176	36,00
158324-9	176	3,00
158325-7	176	8,00
158326-5	176	7,00
140441-9	176	4,20
194930-6	176	14,40
193523-6	176	15,00
193521-0	176	28,00
162172-0	176	37,00
P-43533	177	5,15
P-43549	177	4,90
P-43555	177	4,65
P-43561	177	4,65
P-43577	177	4,65
P-43583	177	4,65
P-43599	177	4,65
P-43608	177	4,40
P-43614	177	4,40
P-33342	177	4,65
P-33358	177	4,40
P-33364	177	4,10
P-33370	177	4,10
P-33386	177	4,10

Código	Pág.	P.V.P. (€)
P-33392	177	4,10
P-33401	177	4,10
P-33417	177	4,10
P-33423	177	4,10
P-31918	177	7,20
P-31924	177	6,95
P-31930	177	6,70
P-31946	177	6,45
P-31952	177	6,45
P-31968	177	6,45
P-31974	177	6,45
P-31980	177	6,45
P-31996	177	6,45
P-32007	177	6,45
P-32013	177	6,45
P-37839	177	6,95
P-37845	177	6,45
P-37851	177	6,20
P-37867	177	5,90
P-37873	177	5,90
P-37889	177	5,90
P-37895	177	5,90
P-37904	177	5,90
P-37910	177	5,90
P-37926	177	5,90
P-37932	177	5,90
B-39300	178	29,00
B-39316	178	27,00
B-39322	178	48,00
B-39338	178	45,00
B-39344	178	43,00
B-39350	178	42,00
B-39366	178	42,00
B-39372	178	42,00
B-39388	178	42,00
B-39394	178	42,00
B-39403	178	42,00
B-39419	178	42,00
B-39425	178	42,00
B-68389	178	32,00
B-68395	178	31,00
B-68404	178	27,00
B-68410	178	27,00
B-68426	178	27,00
P-00860	178	4,20
P-00882	178	5,50
P-00907	178	5,50
P-00913	178	5,50
P-00935	178	5,80
P-00957	178	5,00
P-00979	178	6,30
P-00985	178	6,30
P-00991	178	6,55
P-01002	178	6,85
P-01018	178	6,85
P-01030	178	7,90
P-01052	178	8,15
P-01074	178	8,15
P-01080	178	8,15
P-01096	178	7,60
P-01105	178	7,60
P-33439	178	10,30
P-38037	178	8,50
P-33445	178	8,00
P-38043	178	7,70
P-33451	178	7,70
P-38059	178	7,70
P-38065	178	7,70
743015-1	179	8,85
743025-8	179	4,65
743016-9	179	9,55
743008-8	179	23,00
743012-7	179	15,45
224515-5	179	5,15
197925-8	179	58,00
197922-4	179	57,00
197928-2	179	57,00
743060-6	179	15,45
P-21777	179	12,35
743053-3	179	19,55
199939-3	179	54,00
199940-8	179	61,00
199938-5	179	59,00
P-37091	180	9,25
P-37100	180	9,00
P-37116	180	9,00
P-37122	180	9,00
P-37138	180	9,00
P-37144	180	9,00
P-37150	180	9,00
P-37172	180	9,25
P-37188	180	9,80
P-37194	180	8,75

Código	Pág.	P.V.P. (€)
P-37203	180	8,50
P-37219	180	8,50
P-37225	180	8,50
P-37231	180	8,50
P-37312	180	10,80
P-37328	180	10,30
P-37334	180	9,80
P-37340	180	9,00
P-37356	180	9,00
P-37362	180	9,00
P-37378	180	9,00
P-36887	180	12,90
P-36893	180	11,85
P-36902	180	11,85
P-36918	180	11,85
P-36924	180	11,85
P-36930	180	11,85
P-36946	180	11,85
423036-6	180	2,20
423029-3	180	2,80
421648-9	180	3,50
193201-8	180	7,30
423315-2	180	2,35
423316-0	180	2,85
193202-6	180	4,90
423312-8	180	2,05
421093-8	180	4,10
423035-8	180	3,85
421646-3	180	2,60
423149-3	180	2,60
423313-6	180	2,60
342328-3	180	2,85
341705-6	180	3,35
151751-9	180	8,00
151749-6	180	5,15
151750-1	180	5,15
150980-1	180	5,15
344620-3	180	2,15
344586-7	180	2,60
A-34534	181	20,10
A-34540	181	19,05
A-34556	181	18,00
A-34447	181	21,00
A-34453	181	21,00
A-34469	181	19,05
A-34475	181	16,50
A-34481	181	16,50
A-34562	181	23,00
A-34578	181	23,00
A-34584	181	22,00
A-34590	181	22,00
A-34609	181	19,05
P-39394	181	30,00
P-39419	181	30,00
P-39425	181	30,00
P-36675	181	4,90
P-36681	181	4,40
P-36697	181	4,40
P-36706	181	4,40
P-36712	181	4,40
P-36728	181	4,40
P-36734	181	4,40
B-42581	181	13,40
B-42597	181	13,40
P-43181	181	5,40
P-43197	181	5,40
P-43206	181	5,15
P-43212	181	5,15
P-43228	181	5,15
P-43234	181	5,15
P-43240	181	5,15
P-43256	181	6,20
P-43262	181	6,20
P-43278	181	5,90
P-43284	181	5,90
P-43290	181	5,90
P-43309	181	5,90
P-43315	181	5,90
P-43321	181	8,00
P-43337	181	7,70
P-43343	181	7,45
P-43359	181	7,20
P-43365	181	7,20
P-43371	181	7,45
P-43387	181	7,45
P-01395	181	11,35
P-01404	181	11,35
P-01199	181	10,30
P-01208	181	10,30
P-01214	181	10,30
P-01220	181	10,30
P-01236	181	10,30
E-07412	182	44,00

Código	Pág.	P.V.P. (€)
E-07428	182	44,00
E-07434	182	44,00
E-07440	182	44,00
E-07456	182	44,00
E-07462	182	81,00
E-07478	182	81,00
E-07484	182	81,00
E-07490	182	71,00
E-07509	182	71,00
E-07515	182	71,00
743126-2	182	5,25
743124-6	182	13,40
191N90-9	182	9,55
191N91-7	182	11,85
191N92-5	182	11,85
743125-4	182	35,00
D-56960	182	2,15
743081-8	182	30,00
196685-9	182	24,00
196684-1	182	28,00
196686-7	182	27,00
197315-5	182	49,00
197314-7	182	45,00
197316-3	182	49,00
197317-1	182	45,00
D-70873	182	17,45
197896-9	182	17,00
197897-7	183	14,95
199424-6	183	22,00
794560-9	183	26,00
192629-7	183	19,55
794173-6	183	12,35
794176-0	183	22,00
197895-1	183	27,00
196152-4	183	24,00
794618-4	183	18,50
197893-5	183	17,50
794558-6	183	24,00
197894-3	183	21,00
D-70786	183	17,45
D-70792	183	17,45
P-21727	183	14,40
P-21733	183	10,05
D-62505	183	4,60
D-62511	183	6,50
D-62527	183	7,65
D-62533	183	4,60
D-62549	183	6,50
D-62555	183	7,65
D-62561	183	4,60
D-62577	183	6,50
D-62583	183	7,65
D-62599	183	4,60
D-62608	183	6,50
D-62614	183	7,65
D-62620	183	4,60
D-62636	183	6,50
D-62642	183	7,65
D-62658	183	4,60
D-62664	183	6,50
D-62670	183	7,65
413094-0	184	1,30
450066-4	184	0,90
192989-7	184	7,20
192523-3	184	21,00
193294-5	184	12,35
152456-4	184	20,10
151780-2	184	2,45
151517-7*	184	8,25
135222-4	184	4,60
194746-9*	184	5,15
193712-3	184	6,25
193293-7	184	7,60
168557-8*	184	2,50
135246-0	184	4,65
135327-0	184	2,40

Código	Pág.	P.V.P. (€)
B-66450	198	24,00
B-66438	198	10,05
B-66400	198	12,90
B-66472	199	6,70
B-66466	199	13,40
B-66519	199	38,00
B-66494	200	28,00
B-66503	200	28,00
B-66547	200	27,00
B-66553	200	21,00
B-66575	200	21,00
B-32091	206	18,45
B-32203	206	22,00
B-32297	206	27,00
B-32100	206	22,00
B-32122	206	21,00
B-32225	206	23,00
B-32312	206	25,00
B-08187	206	18,55
B-08327	206	23,00
B-32144	206	23,00
B-32247	206	24,00
B-32340	206	32,00
B-32390	206	35,00
B-32150	206	23,00
B-32253	206	29,00
B-32356	206	34,00
B-32269	206	24,00
B-32362	206	30,00
B-32415	206	32,00
B-32172	206	37,00
B-32378	206	43,00
B-32409	206	47,00
B-32188	206	52,00
B-32281	206	59,00
B-32384	206	63,00
B-33037	207	26,00
B-33093	207	30,00
B-33168	207	34,00
B-33043	207	21,00
B-33174	207	27,00
B-33059	207	21,00
B-33118	207	29,00
B-33180	207	38,00
B-09363	207	25,00
B-33130	207	31,00
B-33196	207	48,00
B-33146	207	60,00
B-33205	207	74,00
B-33211	207	75,00
B-33087	207	81,00
B-33227	207	107,00
B-31930	208	14,70
B-32007	208	17,90
B-32035	208	21,00
B-32085	208	32,00
D-03327	208	11,45
D-09628	208	12,60
D-03333	208	13,75
D-03349	208	16,60
D-03903	208	12,60
D-09634	208	13,70
D-03919	208	15,45
D-29050	208	23,00
D-03925	208	19,20
D-03931	208	23,00
D-09640	208	29,00
D-52554	209	7,20
D-52560	209	8,45
D-52576	209	10,25
D-52582	209	9,05
D-52598	209	10,25
D-52607	209	11,45
D-64951	209	10,55
D-64967	209	12,05
D-64973	209	14,35
D-72291	209	13,05
D-72300	209	14,25
D-52613	209	15,65
D-52629	209	18,10
D-52635	209	20,50
B-33233	210	39,00
B-33261	210	55,00
B-33548	210	55,00
B-33277	210	63,00
B-33554	210	26,00
B-27246	210	28,00
B-13699	210	32,00
B-63149	211	59,00
B-33582	211	87,00
B-33598	211	125,00
B-33607	211	151,00
B-14607	211	9,55

Código	Pág.	P.V.P. (€)
792299-8	211	13,40
792259-0	211	10,30
B-10643	211	24,00
B-32954	211	25,00
B-32910	211	23,00
B-62979	211	29,00
B-57336	211	47,00
B-32926	211	21,00
B-32976	211	24,00
E-06971	211	45,00
E-01909	211	41,00
B-32982	212	29,00
B-56699	212	44,00
B-32998	212	35,00
B-33015	212	53,00
B-56708	212	69,00
B-56720	212	57,00
B-10344	212	60,00
B-56742	212	66,00
B-33021	212	57,00
B-56714	212	68,00
B-08757	213	45,00
B-42640	213	92,00
B-42662	213	92,00
B-42830	213	92,00
B-42852	213	92,00
B-42678	213	103,00
B-42868	213	103,00
B-32568	213	73,00
B-32708	214	23,00
B-08953	214	33,00
B-09042	214	33,00
A-86169	214	45,00
B-32764	214	41,00
A-86468	214	69,00
B-33308	214	42,00
B-32873	214	50,00
B-32720	214	52,00
B-32792	214	38,00
B-32770	214	37,00
B-32801	214	45,00
B-32845	214	48,00
B-32873	214	50,00
B-67240	214	65,00
B-32786	214	48,00
B-32817	214	63,00
B-32851	214	75,00
B-32889	214	82,00
B-67256	214	65,00
B-33283	215	41,00
B-33299	215	48,00
B-33314	215	68,00
B-33320	215	63,00
B-33336	215	70,00
E-06317	215	81,00
B-33342	215	66,00
B-33358	215	92,00
D-72316	215	33,00
D-72322	215	37,00
D-72338	215	42,00
B-05072	216	43,00
JM27170001	216	31,00
B-33386	216	71,00
B-33392	216	77,00
B-09737	216	101,00
B-33853	216	103,00
B-29496	216	95,00
B-33881	216	157,00
B-48832	217	166,00
B-48860	217	183,00
199087-8	217	68,00
199085-2	217	68,00
199083-6	217	68,00
198603-3	217	9,40
E-11097	217	67,00
B-10615	218	44,00
B-07325	218	44,00
B-23086	218	73,00
B-47036	218	41,00
B-47042	218	57,00
B-47058	218	62,00
B-47064	218	57,00
B-33445	218	53,00
B-33451	218	52,00
B-33423	218	47,00
B-33417	218	65,00
B-33439	218	115,00
B-33467	218	139,00
A-87579	218	237,00
B-33750	218	283,00
198885-7	220	25,00
199140-0	220	45,00
194368-5	220	71,00

Código	Pág.	P.V.P. (€)
194925-9	220	109,00
194367-7	220	185,00
E-05670	220	46,00
E-05664	220	53,00
E-10920	220	83,00
E-10936	220	103,00
196664-7	220	39,00
192505-5	220	29,00
192506-3	220	114,00
192507-1	220	85,00
197252-3	220	66,00
198570-2	220	215,00
197462-2	220	27,00
197005-0	220	65,00
196953-0	220	52,00
199232-5	220	52,00
413101-9	220	4,10
451330-6	220	6,20
413102-7	220	15,45
423359-2	220	5,65
423386-9	220	8,25
423360-7	220	11,00
423361-5	220	6,70
423390-8	220	9,25
423362-3	220	15,45
194385-5	221	28,00
195333-7	221	3,05
164095-8	221	1,80
165108-8	221	6,45
165084-6	221	4,20
152498-8	221	47,00
165447-6	221	15,85
143396-7	221	4,10
199386-8	221	15,65
199231-7	221	8,85
198688-9	221	187,00
DEAWST05	221	326,00
DEBWST06	221	297,00
DEAWST07	221	407,00
194093-8	222	350,00
JM27000300	222	257,00
122446-1	222	27,00
256812-1	222	24,00
192628-9	222	40,00
192669-5	222	71,00
A-47450	222	102,00
164806-1	222	7,70
322932-4	222	6,50
123101-8	222	14,95
191239-7	222	28,00
JM23000127	222	9,25
195240-4	222	9,00
JM23100500	222	10,70
327095-1	222	5,50
194002-7	222	56,00
122571-8	223	21,90
JM23510009	223	10,30
122538-6	223	18,55
192625-5	223	19,00
122854-6	223	25,00
122728-1	223	16,50
JM23100502	223	6,10
126617-2	223	28,00
JM23000131	223	7,70
122567-9	223	41,00
122470-4	223	85,00
122930-6	223	74,00
122739-6	223	116,00
122707-9	223	16,10
122729-9	223	27,00
JM23300008	223	52,00
JM27110005	223	37,00
417113-4	223	0,60
166058-0	223	10,80
127069-0	223	46,00
122730-4	223	15,45
194087-3	223	41,00
194086-5	223	34,00
122472-0	223	5,15
JM23000128	223	0,75
193730-1	224	3,80
JM23100501	224	3,45
122351-2	224	7,95
JM23510010	224	6,70
122330-0	224	14,95
122852-0	224	3,55
194175-6	224	37,00
257022-3	224	0,80
257060-5	224	1,30
257262-3	224	0,80
416772-1	224	4,05
B-16857	227	20,10
P-47008	227	19,25

Código	Pág.	P.V.P. (€)
P-46997	227	15,00
B-43212	227	24,00
B-43181	227	21,00
B-43147	227	17,25
P-45727	227	25,00
P-45711	227	20,85
P-45705	227	17,10
B-55572	227	17,50
B-55588	227	21,00
B-55594	227	27,00
P-04955	228	15,50
B-43169	228	17,50
B-16835	228	11,85
P-04896	228	13,90
B-16776	228	16,50
B-05169	228	12,90
P-04874	228	13,90
B-43206	228	24,00
B-43175	228	21,00
B-43131	228	16,50
B-16782	228	16,50
B-16841	228	11,85
B-43228	228	24,00
B-43197	228	21,00
B-43153	228	16,50
B-16807	229	9,00
B-16829	229	14,95
P-47092	229	13,90
P-47086	229	12,85
P-05088	229	20,35
B-16863	229	19,05
P-47117	229	15,50
B-16798	229	9,00
P-47101	230	19,25
B-16813	230	9,00
P-47123	230	16,60
B-62016	230	15,45
B-05038	230	16,50
B-05044	230	14,40
B-05153	230	14,95
B-54265	231	385,00
P-47064	231	18,55
B-43278	231	30,00
B-43256	231	26,00
B-43234	231	21,00
B-05175	231	14,95
P-45696	231	20,85
P-45680	231	17,10
P-47195	232	19,80
P-47189	232	15,00
P-67767	232	24,00
P-47014	232	14,40
B-43262	232	17,50
B-43240	232	12,90
B-31859	232	17,50
B-31843	232	12,90
B-67206	232	271,00
P-05066	233	46,00
P-05050	233	51,00
P-05044	233	24,00
P-05038	233	20,85
B-10403	233	47,00
B-10394	233	34,00
B-12809	233	26,00
P-47173	233	16,05
B-52043	233	22,00
B-10609	233	9,55
B-30564	233	22,00
B-07250	233	30

Código	Pág.	P.V.P. (€)
193516-3	250	9,55
192732-4	250	8,20
415524-7	250	0,75
416477-3	250	0,50
417852-6	250	2,60
192349-3	250	7,70
417853-4	250	1,05
D-30209	253	21,35
D-53534	253	63,00
D-53540	253	65,00
D-09167	253	9,55
D-10001	253	7,70
D-10017	253	8,50
D-10023	253	8,50
D-10039	253	8,75
D-09210	254	17,40
D-09226	254	18,30
D-09232	254	8,75
D-09248	254	8,75
D-09254	254	8,75
D-09260	254	8,75
D-09276	254	9,00
D-09282	254	9,00
D-09298	254	9,55
D-09307	254	10,80
D-09313	254	12,60
D-10051	254	10,30
D-10067	254	11,35
D-10285	254	16,50
D-10291	254	18,55
D-10300	254	21,00
D-10316	254	21,00
D-10322	254	22,00
D-10338	254	25,00
D-10344	254	24,00
D-10350	254	26,00
D-10366	254	28,00
D-10372	254	28,00
D-10176	254	11,85
D-10182	254	12,90
D-10388	254	21,00
D-10198	254	12,90
D-10419	254	25,00
D-10425	254	30,00
D-10431	254	28,00
D-10447	254	31,00
D-10453	254	32,00
D-10469	254	32,00
D-10475	254	32,00
D-09335	254	12,90
D-10584	254	14,95
D-09341	254	24,00
793061-4	254	32,00
D-09329	255	12,90
D-09472	255	15,20
D-10497	255	21,00
D-09422	255	17,50
D-09444	255	22,00
D-09357	255	19,55
D-09363	255	24,00
D-09575	255	25,00
D-09553	255	26,00
D-09581	255	24,00
D-11829	255	65,00
D-09525	255	18,55
D-09547	255	22,00
D-09494	256	21,00
D-09488	256	21,00
D-09400	256	25,00
D-09416	256	24,00
D-12027	256	41,00
D-09391	256	23,00
D-09379	256	23,00
D-09385	256	22,00
D-10687	256	15,95
D-10693	256	18,55
D-10702	256	15,95
D-10718	256	19,05
D-10746	256	31,00
D-16988	257	10,80
733240-2	257	3,60
733232-1	257	10,80
193483-2	257	5,15
B-20644	258	24,00
A-16564	258	366,00
A-16570	258	364,00
A-16586	258	384,00
A-16592	258	430,00
A-16601	258	493,00
A-16617	258	757,00
181434-7	258	1,25
P-08844	258	46,00
P-08850	258	46,00

Código	Pág.	P.V.P. (€)
122235-4	258	319,00
221502-5	258	17,00
122473-8	259	38,00
123149-0	259	19,90
782401-1	259	0,90
763607-0	259	2,60
763608-8	259	3,10
763662-2	259	3,80
763663-0	259	4,10
763622-4	259	15,45
763628-2	259	15,45
763632-1	259	24,00
763601-2	259	38,00
763636-3	259	10,80
763637-1	259	9,00
763618-5	259	2,60
193180-0	259	24,00
193178-7	259	21,00
415579-2	259	7,50
122474-6	259	7,10
123150-5	259	6,55
781213-9	259	2,05
781006-4	259	1,80
781008-0	259	1,80
781011-1	259	2,05
781012-9	259	2,15
781030-7	259	2,60
763801-4	260	3,10
763804-8	260	3,10
763807-2	260	3,60
763803-0	260	3,10
763606-2	260	3,85
763615-1	260	3,10
763652-5	260	4,10
763629-0	260	6,20
763674-5	260	6,70
193448-4	260	24,00
193449-2	260	6,70
324149-5	260	11,00
763608-8	260	3,10
763677-9	260	12,35
763676-1	260	14,95
763606-2	260	3,85
763258-9	260	5,40
343577-5	261	0,75
164379-4	261	13,90
164775-6	261	12,90
164388-3	261	11,85
164776-4	261	13,40
344364-5	261	2,60
164393-0	261	16,00
164470-8	261	13,00
163080-8	261	10,80
164471-6	261	11,05
165046-4	261	16,00
193331-5	261	13,40
193332-3	261	9,55
193334-9	261	10,80
193335-7	261	16,20
193340-4	261	13,40
193336-5	261	12,35
193338-1	261	12,90
193339-9	261	14,40
252627-4	261	10,30
321492-3	261	15,45
321812-1	261	10,05
198885-7	262	25,00
199140-0	262	45,00
194368-5	262	71,00
194925-9	262	109,00
194367-7	262	185,00
E-05670	262	46,00
E-05664	262	53,00
E-10920	262	83,00
E-10936	262	103,00
194385-5	262	28,00
194579-2	262	36,00
196613-4	263	26,00
454842-8	263	2,40
195563-0	263	70,00
450819-1	263	3,00
198987-9	263	31,00
413150-6	263	2,50
195562-2	263	82,00
413148-3	263	4,50
122703-7	264	3,50
123022-4*	264	13,00
STEX122385	264	36,00
122343-1	264	25,00
266491-7	264	2,05
123544-4	264	28,00
193904-4	264	46,00
194268-9	264	13,10

Código	Pág.	P.V.P. (€)
194267-1	264	15,50
194270-2	264	41,00
122700-3	264	17,50
195564-8	264	6,10
415412-8	264	5,00
194934-8	264	10,80
194733-8	264	2,25
195559-1	264	3,35
122391-0	264	6,30
164834-6	264	4,25
342428-9	264	6,85
195136-9	264	53,00
PR00000029	267	7,65
PR00000028	267	7,65
PR00000030	267	9,85
PR00000031	267	8,20
PR00000039	267	9,00
PR00000032	267	16,30
PR00000033	267	17,90
PR00000034	267	7,65
PR00000035	267	10,35
PR00000041	267	20,75
P-71439	268	7,45
P-71445	268	7,45
P-71489	268	11,35
P-71554	268	19,55
P-71495	268	13,90
P-71510	268	24,00
P-71526	268	24,00
P-71532	268	24,00
F-31227	271	15,20
F-31230	271	16,75
F-30913	271	15,70
F-31166	271	20,10
F-31182	271	26,00
F-31140	271	21,00
P-38283	271	29,00
F-32843	271	35,00
F-32856	271	39,00
F-32869	271	32,00
F-32872	271	33,00
F-32885	271	35,00
F-32898	271	41,00
F-32142	272	25,00
F-32155	272	29,00
F-32168	272	33,00
F-32171	272	37,00
F-31825	272	13,40
F-31838	272	14,40
F-31841	272	16,20
F-31854	272	18,00
P-45923	272	11,55
P-45939	272	13,20
P-45945	272	15,40
P-45951	272	16,50
P-45967	272	19,25
F-33562	272	44,00
F-33575	272	53,00
F-33588	272	55,00
F-33591	272	84,00
196285-5	272	82,00
196286-3	272	82,00
196287-1	272	82,00
196288-9	272	82,00
196289-7	272	82,00
196290-2	272	76,00
196291-0	272	76,00
196292-8	272	76,00
196293-6	272	76,00
196294-4	272	76,00
196246-5	273	201,00
P-45864	273	14,85
P-45870	273	15,95
P-45886	273	19,80
P-45892	273	23,00
P-45901	273	25,00
P-45917	273	28,00
F-32647	273	13,90
F-32650	273	12,35
F-32663	273	16,50
F-32676	273	18,55
F-32689	273	19,55
F-81518	273	23,50
F-81521	273	18,00
181434-7	273	1,25
419525-7	273	1,45
242094-1	274	16,50
242077-1	274	10,80
242088-6	274	14,40
242075-5	274	19,55
195246-2	274	4,40
194852-0	274	45,00
B-80020	274	295,00

Código	Pág.	P.V.P. (€)
B-80014	274	201,00
B-80036	274	164,00
HY00000212	274	193,00
P-70328	280	108,00
W15331	280	31,00
P-70390	280	14,95
P-70409	280	14,40
122335-0	281	14,40
122335-2	281	-
122520-5	281	8,25
123488-8	281	10,30
123539-7	281	10,30
126756-8	281	8,45
127093-3	281	10,80
140G19-0	281	20,70
140G26-3	281	9,20
140H95-0	281	5,15
140J64-3	281	7,60
143787-2	281	30,00
191657-9	281	14,40
191D71-3	281	39,00
191D76-3	281	5,95
191D79-7	281	4,35
192236-6	281	5,65
192562-3	281	9,10
192563-1	281	8,65
195433-3	281	59,00
195434-1	281	59,00
195435-9	281	109,00
195436-7	281	72,00
195437-5	281	47,00
195439-1	281	100,00
195551-7	281	27,00
197901-2	281	6,55
198149-9	281	14,40
198527-3	281	14,40
198529-9	281	14,40
198532-0	281	23,00
198533-8	281	24,00
198537-0	281	7,20
198538-8	281	5,40
198540-1	281	5,40
198544-3	281	8,25
198545-1	281	8,25
198547-7	281	8,25
198552-4	281	5,40
198553-2	281	5,40
198555-8	281	5,40
198559-0	281	18,75
198560-5	281	23,00
198990-0	281	2,20
198992-6	281	2,20
199041-2	281	7,20
199388-4	281	59,00
199439-3	281	3,80
199453-9	281	16,45
199454-7	281	29,00
199455-5	281	29,00
199491-1	281	36,00
199493-7	281	18,65
199971-7	281	5,25
191M50-5	281	54,00
410306-2	281	3,40
416041-0	281	1,30
451241-5		

Código	Pág.	P.V.P. (€)
LE00785633	295	14,40
LE00789389	295	42,00
LE00791661	295	97,00
P-81309	296	72,00
LE00785638	296	16,75
LE00823195	296	23,00
LE00822220	296	29,00
LE00864505	296	36,00
LE00929103	296	43,00
LE00834534	296	18,55
LE00772796	296	24,00
TK02100200	296	18,55
199010-3	296	12,90
199178-5	296	10,30
125354-5	298	116,00
725129-8	298	68,00
725130-3	298	58,00
A-83951	298	26,00
792728-1	298	27,00
792534-4	298	59,00
792537-8	298	76,00
191383-0	298	29,00
792533-6	298	45,00
792536-0	298	45,00
792287-5	298	32,00
A-15051	298	22,00
792292-2	298	26,00
762013-6	298	3,85
762007-1	298	4,35
783201-2	298	1,05
783208-8	298	1,05
783202-0	298	1,05
781028-4	298	3,00
781019-5	298	3,10
341796-7	298	1,05
SC03801080	299	88,00
SC03300790	299	80,00
SC05340040	300	108,00
SC05340050	300	108,00
SC05340060	300	108,00
SC05340070	300	108,00
SC05340080	300	108,00
SC05340090	300	108,00
SC05340100	300	108,00
SC05340110	300	108,00
SC05340120	300	108,00
SC05340130	300	108,00
SC05340140	300	108,00
SC05340150	300	108,00
SC05340160	300	108,00
SC00000203	300	108,00
SC00000205	300	108,00
SC00000207	300	108,00
SC00000209	300	108,00
SC00000211	300	108,00
SC00000213	300	108,00
SC00000215	300	108,00
SC00000217	300	108,00
SC00000219	300	108,00
SC00000221	300	108,00
SC05332710	300	108,00
SC00000223	300	108,00
SC05352510	300	108,00
SC05340200	300	149,00
SC05340210	300	149,00
SC05340220	300	149,00
SC05340230	300	149,00
SC05340240	300	149,00
SC05340250	300	149,00
SC05340260	300	149,00
SC05340270	300	149,00
SC05340280	300	149,00
SC05340290	300	149,00
SC05340300	300	149,00
SC05340310	300	149,00
SC00000244	300	108,00
SC00000246	300	108,00
SC00000248	300	108,00
SC00000250	300	108,00
SC00000252	300	108,00
SC00000254	300	108,00
SC00000256	300	108,00
SC00000258	300	108,00
SC00000260	300	108,00
SC00000262	300	108,00
SC00000264	300	108,00
SC00000266	300	108,00
158476-6	304	21,00
161846-0	304	14,40
168395-8	304	55,00
168408-5	304	11,70
165245-8	304	13,90
165441A8	304	22,00

Código	Pág.	P.V.P. (€)
165247-4	304	22,00
165441A8	304	22,00
165247-4	304	22,00
791284-8	304	14,75
199075-5	304	12,95
512466760	304	18,00
511492740	304	13,40
196740-7	304	18,55
511492752	304	13,65
511291756	304	14,15
511492752	304	13,65
511492756	304	14,15
199067-4	305	3,00
199067-4	305	3,00
199067-4	305	3,00
452093-7	305	1,90
419288-5	305	*
952010640	305	4,90
419242-9	305	2,80
952010640	305	4,90
952010640	305	4,90
195050-9	306	37,00
195321-4	306	22,00
198401-5	306	9,10
194681-1	306	23,00
191R51-3	306	45,00
191R52-1	306	73,00
191T43-4	306	15,60
191D34-9	306	36,00
158024-1	306	1,60
194678-0	306	2,05
953100090	306	6,20
D-72154	306	23,00
D-72160	306	23,00
953004010	306	2,30
953003060	306	6,45
953004010	306	2,30
953003090	306	2,15
953003070	306	2,15
953003110	306	2,15
953003040	306	2,15
953030010	306	14,95
197712-5	306	7,45
953009000	306	13,90
941716132	306	2,85
941719133	306	2,85
941713001	306	2,30
451753-8	307	4,10
183P98-9	307	10,85
183P97-1	307	10,60
191L14-3	307	6,20
191B21-6	307	*
183P98-9	307	10,85
183P97-1	307	10,60
183R02-0	307	7,10
191J13-3	307	9,70
166094-6	307	3,75
127425-4	307	9,80
127501-4	307	8,25
127502-2	307	16,90
452123-4	307	12,35
191L96-5	307	10,65
183P98-9	307	10,85
166094-6	307	3,75
455634-8	307	13,15
197724-8	307	15,45
454896-5	307	7,70
197235-3	307	66,00
191B03-8	307	86,00
191E19-1	307	69,00
191T38-7	309	180,00
196345-3	309	279,00
198068-9	309	332,00
197750-7	309	228,00
195663-6	309	112,00
199318-5	309	544,00
195566-4	309	84,00
195717-9	309	268,00
199339-7	309	570,00
191P72-3	309	159,00
191C15-7	309	8,75
191E27-2	309	118,00
191M75-9	309	464,00
191M56-3	309	510,00
199874-5	310	38,00
195299-1	310	21,95
385224150	310	25,00
DA00000169	310	15,45
B-14118	310	11,35
B-14124	310	11,85
B-14130	310	11,85
B-14146	310	13,40
199872-9	310	25,00

Código	Pág.	P.V.P. (€)
B-14152	310	13,40
B-14168	310	14,95
385224250	310	8,75
381224230	310	5,65
382224310	310	7,70
UA-1048	310	3,85
DA00000002	313	8,00
195858-1	313	7,00
191D92-5	313	17,50
191D91-7	313	17,50
123235-7	313	11,35
384224270	313	23,00
385224240	313	17,25
680224200	313	14,15
381224240	313	17,25
382224300	313	19,55
196148-5	314	4,85
B-01971	314	2,30
B-07375	314	3,10
369224807	314	2,15
369224808	314	2,45
369224790	314	2,60
369224791	314	10,80
369224792	314	3,35
369224793	314	11,05
369224794	314	29,00
369224809	314	4,10
369224811	314	11,05
369224815	314	29,00
369224810	314	4,65
369224812	314	11,05
369224816	314	29,00
369224795	314	3,85
369224796	314	11,05
369224797	314	29,00
369224819	314	4,90
369224821	314	11,05
369224825	314	29,00
369224820	314	4,90
369224822	314	11,05
369224826	314	29,00
369224823	314	11,05
369224827	314	29,00
369224824	314	11,05
369224828	314	29,00
369224798	314	4,90
369224799	314	13,15
369224800	314	33,00
369224801	314	52,00
369224802	314	5,40
369224803	314	13,15
369224804	314	34,00
369224805	314	52,00
E-01769	315	3,10
E-01775	315	5,80
E-01781	315	42,00
E-01797	315	3,90
E-01806	315	7,35
E-01812	315	44,00
E-01828	315	4,45
E-01834	315	8,15
E-01840	315	42,00
197188-6	315	28,00
197189-4	315	22,00
198383-1	315	26,00
198426-9	315	13,25
980008106	316	1,90
980008107	316	6,70
980008112	316	11,35
980008118	316	31,00
980008103	316	11,85
980008120	316	4,10
980008210	316	5,95
980008211	316	29,00
196122-3	316	2,60
197010-7	316	5,15
988002256	316	4,40
988002258	316	18,55
980008121	316	7,70
980008125	316	9,25
196335-6	317	51,00
196129-9	317	51,00
122907-1	317	25,00
191E43-4	317	13,55
197243-4	317	5,65
P-47363	317	10,30
P-47357	317	8,50
988000040	317	27,00
E-07294	318	100,00
E-07303	318	117,00
E-07319	318	138,00
E-07325	318	31,00
E-07630	318	11,25

Código	Pág.	P.V.P. (€)
E-07646	318	12,35
E-07652	318	14,45
E-07331	318	3,20
327685-0	318	36,00
327684-2	318	31,00
327687-6	318	27,00
191P11-3	318	143,00
B-54346	319	185,00
B-54352	319	190,00
B-54368	319	214,00
B-54374	319	253,00
B-54380	319	47,00
195595-7	319	190,00
192755-2	319	194,00
953003090	319	2,15
199897-3	319	4,10
783002-8	319	1,80
783012-5	319	0,55
197367-6	320	44,00
197366-8	320	50,00
199169-6	320	123,00
199168-8	320	98,00
A-86664	320	46,00
B-05016	320	32,00
161377-9	320	35,00
794530-8	320	12,35
182470-6	320	1,40
198408-1	321	30,00
195769-0	321	92,00
199098-3	321	103,00
199099-1	321	103,00
196688-3	321	134,00
191D39-9	321	160,00
191C14-9	321	129,00
191R54-7	321	155,00
191R55-5	321	155,00
191R56-3	321	170,00
140830-8	321	62,00
194663-3	321	38,00
194666-7	321	44,00
194671-4	321	77,00
194673-0	321	62,00
195272-1	321	23,00
195176-7	321	49,00
191N24-2	321	22,00
191N23-4	321	30,00
458342-0	321	4,00
452055-5	321	2,40
195187-2	321	58,00
198516-8	321	60,00
UL23-08/C	321	48,00
HW3320152	322	8,65
HW41847	322	51,00

Álava
01012 Vitoria
Talleres Ramón - Aitor Gómez Ortiz De Zárate
Portal de Arriaga, 59
Telf.- 945 27 58 80

Albacete
02005 Albacete
González Tèbar, Espj
C/ Teruel, 21
Telf.- 967 22 87 62

Alicante
03015 Alicante
Alicantina de Electromecánica
C/ Rafael García Vidal, 16
Telf.- 965 24 18 37

Alicante
03204 Elche
Electricidad Mateu e Hijos
C/ La Torre, 47
Telf.- 966 63 66 55

Alicante
03204 Elche
Elmec Torres, S.L.
Avda. Llauradors, 5
Telf.- 966 65 53 10

Almería
04003 Almería
Rep. Elect. José Sánchez Alfaro
C/ Méndez, 11
Telf.-950 23 00 10

Ávila
05003 Ávila
Montajes Eléctricos Diego Díez
C/ De Los Hornos Caleros, 66
Telf.- 920 22 01 50

Badajoz
06300 Zafra
Reparaciones Eléctricos Vázquez, S.L.
Pol. Ind. Los Caños, S/N C/Zujar, P-282-E
Telf.- 924 55 41 66

Baleares
07004 Palma De Mallorca
Talleres Guillamón - Idea Bros, S.L.
C/ Merce Rodoreda, 11b
Telf.- 971 75 27 50

Baleares
07760 Ciudadela, Menorca
Electromecánica Maybo, S.L.
C/ Fusters, Parcela 11, Modulo 5
Telf.- 971 38 48 39

Baleares
07813 Puig D'en Valls
Talleres Rigo Ibiza Cb
C/ Ses Baldraques, 6
Telf.- 971 31 04 63

Barcelona
08004 Barcelona
Mecaeléctric - Daniel Rivas Figueras
C/ Ricart,23
Telf.- 93 008 46 52

Barcelona
08100 Mollet Del Valles
Som Assistència Tools
C/ Maria Fortuny, 25
Telf.- 93 109 51 25

Barcelona
08224 Tarrasa
Talleres Prats, Scp
C/ Josep Trueta, 100
Telf.- 93 789 06 58

Barcelona
08520 Les Franqueses del Vallés
Bobinajes Robles S.L.
C/ Verge de Monserrat, 5
Telf.- 93 846 39 53

Barcelona
08800 Vilanova I La Geltru
Victor Huguet Llaverias
C/ Carrer de L'aigua, 4
Telf.- 93 893 00 11

Barcelona
08904 L'hospitalet de Llobregat
Talleres Perser - Esteve Barba Velarde
Pasaje Oliveras, 16
Telf.- 93 334 25 98

Burgos
09007 Burgos
Electro Caor
C/ Alcalde Martín Cobos, Sn Pol. Ind. Villayuda
Telf.- 947 48 42 22

Burgos
09200 Miranda del Ebro
Talleres Eléctricos Ebro, S.L.
Pol. Ind. Bayas R-124
Telf.- 947 33 01 51

Cádiz
11405 Jerez de la Frontera
Comosa - Moisés Sánchez Rodríguez
C/ Torreblanca, 7 Local C
Telf.- 956 34 85 01

Castellón
12500 Vinaros
Cyo Electromecánica Scp
Ctra. Uldecona, 24 Nave 7
Telf.- 964 45 01 51

Ciudad Real
13005 Ciudad Real
Alquileres Ciudad Real, S.L.
Pol. Ind. Ctra. Carrión, Avd. Isaac Peral N-118
Telf.- 902 45 46 50

Ciudad Real
13300 Valdepeñas
Leandro Marques Romero
C/ Veracruz 109
Telf.- 926 31 30 11

Córdoba
14013 Córdoba
Bobinados Pastor, S.L.
C/ Ingeniero Rivera S/N, Pol. Amargecena
Telf.- 957 34 31 32

Córdoba
14800 Priego de Córdoba
Rafael Sánchez Ruiz
C/ Ramón y Cajal, 81 Bajo
Telf.- 957 70 01 82

La Coruña
15570 Ferrol
Electricidad Alycar, S.L.
C/ Inca La Gandara, Avda. Nicasio Pérez, Parc 8
Telf.- 981 32 04 81

La Coruña
15650 Cambre
Electromecánica Mayan
Rua Zeppelin, 21-23 Parc. 19 Nave 1
Telf.- 981 64 98 65

La Coruña
15660 Cambre
Istega S.L.
Ctra. De Cambre al Temple, 106-A Barcala
Telf.- 981 25 41 25

La Coruña
15890 Santiago de Compostela
Talleres Eléctricos Lorenzo S.L.
Pol. Ind. Del Tambre, Vía Copérnico 13
Telf.- 981 588 039

Gerona
17003 Gerona
Jordi Planas Grabulosa (Planas Mateu Electric)
C/ Botet I Siso, 9
Telf.- 972 21 21 53

Gerona
17520 Puigcerda
Josep M Sirvent Puig
Carre Puigmal, 5
Telf.- 972 14 10 95

Granada
18006 Granada
Tall. Electromecánico Lupiáñez, S.L.
C/ Juncos S/N, Pol. Ind. La Purísima
Telf.- 958 12 60 20

Granada
18151 Ojigares
Talleres Eléctricos Imbersa S.L.
Pol. Tecnológico De Ojigares-Armilla Nave 88
Telf.- 958 50 70 33

Guipúzcoa
20014 San Sebastián
Electrozor - Miguel Ángel Zorzano Imana
Pº. Urbarburu, 9 - Pol. 27
Telf.- 943 45 14 93

Guipúzcoa
20120 Hernani
Talleres Electromecánicos Loyola, S.L.
Pol. Ind. Zubiondo Industrialdea , Parcela C-5
Telf.- 943 45 24 80

Huelva
21007 Huelva
Electromecánica Juman Cb
Pol. Ind. Pavipresa, Nave 14
Telf.- 959 23 05 41

Huesca
22006 Huesca
Talleres Eléctricos La Alameda, S.L.
C/ La Magantina, 21
Telf.- 974 24 11 18

Jaen
23001 Jaen
S.C.A Electromecánica Higuera
Ctra. De la Guardia, Carril 4 Izda.
Telf.- 953 23 94 22

León
24199 Sta. Olaja de la Ribera
Comercial Talleres Electron, S.L.
Ctra. De Villarroaño, 135
Telf.- 987 20 18 17

Lerida
25001 Lerida
Electroequip. Luis Fernando Fuentes
C/ Ludovicus Plus, 7 Baixos
Telf.- 973 21 40 07

La Rioja
26005 Logroño
Félix Lázaro López
C/ Valdeosera, 6-8 (Entrada Por Carmen Medrano)
Telf.- 941 20 20 42

La Rioja
26006 Logroño
González Electricidad S.L.
C/ Piqueras 52
941 23 09 07

Lugo
27004 Lugo
Electromecánica Pombo, S.L.
C/ Acacia, 18 Bajo
Telf.- 982 21 13 48

Lugo
27004 Lugo
Albatros Lugo, Cb
C/ Trapero Pardo, 10 Bajo
Telf.- 982 21 69 01

Madrid
28019 Madrid
Talleres Euromadrid
C/ Arroyo Opañel,6
Telf.- 91 565 06 24

Madrid
28400 Collado Villalba
J. Cogorro, S.L.
C/ Nicolasa Fernández, 5
Telf.- 91 850 49 72

Madrid
28903 Getafe
Viremaq, S.L.
Avda. De los Ángeles, 57
Telf.- 91 695 50 61

Madrid
28906 Getafe
Velasco Maquinaria S.L.
C/ Trabajo 3, Nave 2, Pol. Ind. Los Olivos
Telf.- 91 696 27 55

Málaga
29006 Málaga
Fercam Maquinaria Herramientas, S.L.
C/ Doctor Saenz de Tejada, 18
Telf.- 952 35 29 41

Murcia
30007 Zarrandona
José Ángel García Jiménez
Ctra. De Alicante, 271
Telf.- 968 30 02 42

Murcia
30817 Lorca
Diego García Grau
Cno. Viejo del Puerto, S/N - Pol. Ind. Los Peñones
Telf.- 968 46 19 82

Navarra
31014 Rochapea
Electricidad Azanza - Iker Santiago Segura
C/ Cendeas,1 Bajo
Telf.- 948 12 77 44

Navarra
31192 Mutilva Baja
J. A. De La Fuente
C/ K, N° 6, Pol. Ind. Mutilva N/4
Telf.- 948 24 93 23

Orense
32003 Orense
Talleres Ramón - Avelino Salgado Fdez.
Rúa de Progreso, 159 Bajo
Telf.- 988 37 03 91

Asturias
33012 Oviedo
Comercial Y Talleres Ferpra, S.L.
C/ Gregorio Marañón, 19
Telf.- 985 23 46 96

Pontevedra
36004 Pontevedra
Ransen
C/ Sta. Teresa Jesús Jornet
Telf.- 986 84 48 13

Pontevedra
36204 Vigo
Talleres Amoedo, S.L.
Ctra. Provincial, 31 B
Telf.- 986 41 16 96

Pontevedra
36211 Vigo
Masna - Manuel Santos Navarrete
C/ Pintor Colneiro, 7 Semisotano
Telf.- 986 41 68 99

Salamanca
37004 Salamanca
Reparalia - Begoña Iglesias Ullan
C/ Acacias, 9
Telf.- 923 22 31 59

Cantabria
39006
Santander Badysat - Javier Badía Anievas
C/ Fernando de los Ríos, 62 B
Telf.- 942 36 70 71

Cantabria
39600 Revilla De Camargo
Oxido 21, Slu
Centro Empresas Camargo Nv 14 P.i. Trascueto
Telf.- 607 60 59 01

Segovia
40003 Segovia
Tomás Cuéllar Pérez
C/ San Gabriel, 15
921 43 64 65

Sevilla
41008 Sevilla
Electricidad Jar Sevilla, S.L.
Pol. Ind. Store C/ Escarpia Bloque 7 Nave 42
Telf.- 954 35 40 16

Tarragona
43202 Reus
Talleres Capdevila, S.L.
C/ Francés Bartrina, 17
Telf.- 977 31 67 21

Tarragona
43800 Valls
Bobinatges Josep Guxens S.L.
C/ Licoristes, 51 Pol. Ind. Valls
Telf.- 977 61 44 88

Teruel
44001 Teruel
C.b. Talleres Mundo
C/ Yagüe de Salas ,4
Telf.- 978 60 10 54

Toledo
45006 Toledo
Cesar Sánchez Pérez
Pso. De la Rosa, 6-A Local 2
Telf.- 925 25 64 18

Valencia
46009 Valencia
Comercial Mecre - Ricardo José Rojas Argudo
C/ Alfambra 12
Telf.- 96 311 15 57

Valencia
46115 Alfara del Patriarca
Servialfara Slu
Avda. 1° de Mayo 16, Bajo
Telf.- 96 130 95 46

Valencia
46960 Aldaya
Daniel García E Hijos, S.L.
Pol. Ind. B° Del Cristo C/ Solidaridad 17
Telf.- 961 54 88 30

Valladolid
47011 Valladolid
Salmacar Cb
C/ De los Templarios, 6
Telf.- 983 39 96 21

Vizcaya
48013 Bilbao
Talleres Faever, S.L.
Estrada Zalvidea 13, 2ª A Planta Modulo 5
Telf.- 94 441 25 26

Vizcaya
48903 Baracaldo
Electromecánica Etorki - Etorri, Koop. Elk. Txikia.
Pol. Ind. Kareaga, C/ Retuerto 53
Telf.- 94 433 87 75

Zamora
49016 Zamora
Electricidad Viluz 94 S.L.
Avda. Portugal, 13
Telf.- 980 53 66 21

Zaragoza
50004 Zaragoza
Reparaciones Roncal Sc
C/ Aljafería, 16
Telf.- 976 44 51 56 Zamora

Zaragoza
50010 Zaragoza
Aristel Electric 3000 S.L.
C/ Don Pedro de Luna 84, Local
Telf.- 650 08 20 12

Melilla
52006 Melilla
Tc Melilla Maquinaria, S.L.
C/ De la Hortensia 10 Nv. D-20
Telf.- 952 67 87 50



Andorra
Encamp
Mauco S.A.
Urbanit Prat De Salt / Edf. Mauco
Telf.- 00 376 821 557

Andorra
Andorra La Vella
Mavid, S.A.
Cs 110 Edifici Codi Aixovall Planta 1ª Local 3
Telf.- 00 376 741 010



Catálogo de
ACCESORIOS
2022

C/ Juan de la Cierva, 7-15
28823 Coslada (Madrid) España
Telf: (34) 91 671 12 62 Fax: (34) 91 671 82 93



www.makita.es